

Ersatzteilliste

Parts list

Anbaupflüge

Mounted Ploughs

Juwel 7M

Art.Nr. 17510597

01.18

LEMKEN GmbH & Co. KG

Weseler Straße 5, D-46519 Alpen / Postfach 11 60, D-46515 Alpen

Telefon (0 28 02) 81-0, Telefax (0 28 02) 81-220

eMail: lemken@lemken.com, Internet: <http://www.lemken.com>

INHALTSVERZEICHNIS / CONTENTS

Juwel 7M

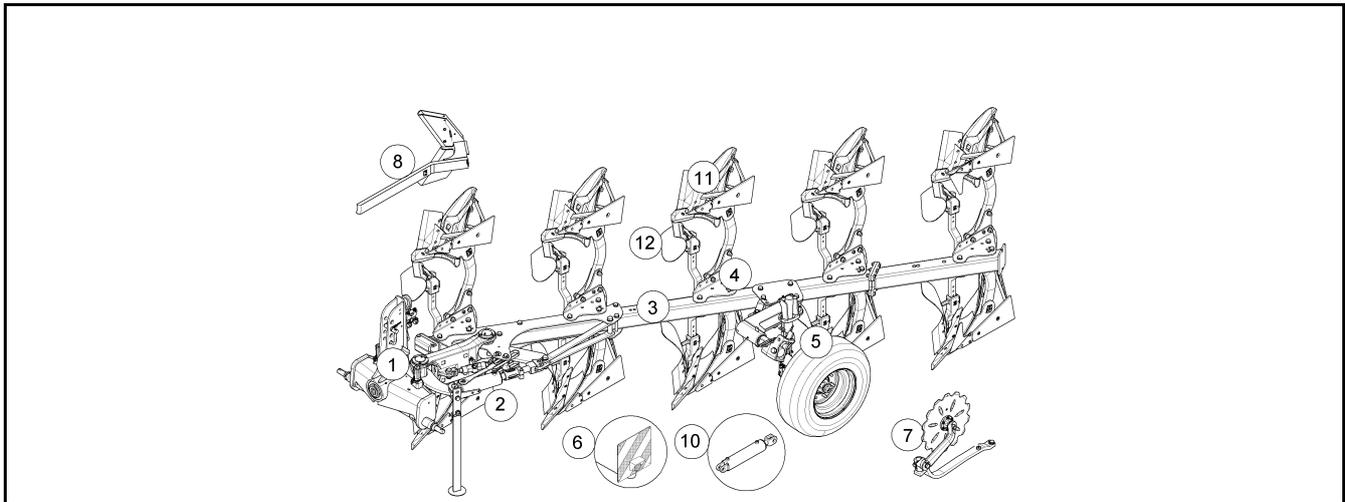

Pos.	Art.Nr.	Artikeltext / Description	Abmessung	
1	313 7911	Oberlenkerbolzen kpl.	Top link pin, cpl.	KAT2G D25,4/31,7x158
1	313 7921	Oberlenkerbolzen kpl.	Top link pin, cpl.	KAT3G D31,7/25,4x158
1	59010055	Aufkleber	Label	Juwel 7 M
1	633 7431	Verriegelung	Locking device	D25x260
1	63310007	Drehwerk	Turnover mechanism	M100
1	63310008	Drehwerk	Turnover mechanism	M100-L
1	63310016	Verriegelung	Locking device	D25x147
1	63310023	Drehwerk	Turnover mechanism	M100
1	63310024	Drehwerk	Turnover mechanism	M100-L
1	661 1385	Unterlenkeranschluss	Lower link connection	E55 L2 Z2
1	661 1387	Unterlenkeranschluss	Lower link connection	E55 L3 Z2
1	661 1388	Unterlenkeranschluss	Lower link connection	E68 L3 Z3
1	661 1394	Unterlenkeranschluss	Lower link connection	E68 L2 Z3
1	661 1443	Unterlenkeranschluss	Lower link connection	J68 L2 Z3
1	661 1444	Unterlenkeranschluss	Lower link connection	J68 L3 Z3
1	66110011	Unterlenkeranschluss	Lower link connection	E55/68 L2 Z2
1	66110012	Unterlenkeranschluss	Lower link connection	E55/68 L3 Z2
2	32110014	Werkzeugsatz	Tool set	Juwel 7
2	629 2510	Abstellstütze	Stand	V-R750-800 915mm
2	629 2511	Abstellstütze	Stand	V-R850/900 D30-1005mm
2	62910007	Abstellstütze	Stand	Juwel R800-850
2	62910018	Abstellstütze	Stand	Juwel 7 R800-850
2	63410001	Zugpunkt-+ Breiteneinstellung	Adjustment centre	Juwel 50/600 M
2	63410002	Zugpunkt-+ Breiteneinstellung	Adjustment centre	Juwel 50/600 HY
2	63410003	Zugpunkt-+ Breiteneinstellung	Adjustment centre	Juwel 7 75/600 M
2	63410004	Zugpunkt-+ Breiteneinstellung	Adjustment centre	Juwel 75/600 HY
2	63410009	Zugpunkteinstellung	Pull point adjustment	Juwel 7 50/600 M RGL
2	63410010	Zugpunkteinstellung	Pull point adjustment	Juwel 7 50/600 HY RGL
3	60210030	Anbauteil	Frame extension	Juwel 7-120-900
3	60210031	Anbauteil	Frame extension	Juwel 7-120-1000
3	60210043	Grundrahmen	Basic frame	J7M(T) 3 L90
3	60210044	Grundrahmen	Basic frame	J7M(T) 4 L90
3	60210045	Grundrahmen	Basic frame	J7M(T) 3 L100
3	60210046	Grundrahmen	Basic frame	J7M(T) 4 L100

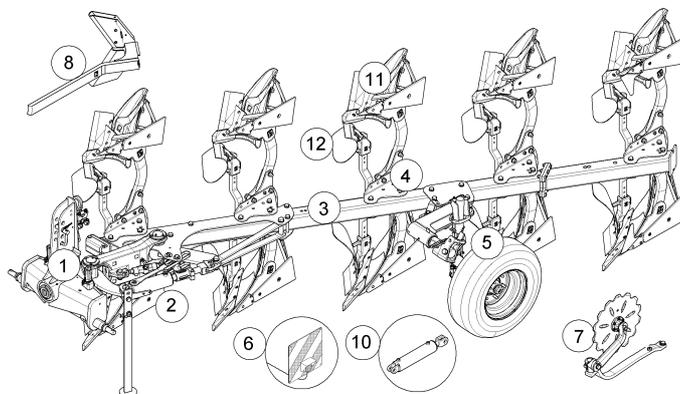

Pos.	Art.Nr.	Artikeltext / Description	Abmessung	
4	464 5006	Körperhalm	Leg	80x30x690-R800 3xD20 1xD14,25
4	464 5007	Körperhalm	Leg	80x30x745-R850 3xD20,1 1xD14,2
4	60210034	Halmtasche	Bracket	Juwel 7
4	60210035	Halmtasche	Bracket	Juwel 7 1K+2K
5	548 2620	Pendelrad-Halm	Wheel stalk	kpl. 5/94/140-L
5	548 2621	Pendelrad-Halm	Wheel stalk	kpl. 5/94/140 K
5	548 2652	Pendelrad-Konsole	Wheel bracket	EurOpal 7
5	54810008	Radhalm mit Lagerung	Wheel stalk with bearing	60x25x553
5	549 8849	Rad	Wheel	5/94/140 D14
5	549 8858	Rad 5/94/140 D14	Wheel 5/94/140 D14	195R15 D650x198 4PR ET-0
5	549 8893	Lagerung	Bearing	5/93,5/140 M14 50x50
5	549 8904	Flanschlager	Flange-type bearing	6/160/205 D18 2xD20
5	54910004	Radhalm	Wheel stalk	Juwel 7 Uni-Rad hydr.
5	54910005	Radkonsole	Wheel bracket	Unirad J7(M)
5	54910006	Dämpferzylinder	Ram	Juwel D50/25x210
5	54910007	Radhalm	Wheel stalk	Juwel 7 Uni-Rad Däm. 6/161/205
5	54910019	Zugfeder	Spring	Juwel Unirad
5	54910024	Schutzblech	Guard	Uni-Rad gedämpft
5	54910025	Abstreifer	Scraper	Unirad GEB 90°
5	550 8862	Rad	Wheel	10.0/75-15.3 10PR AW ET-32
5	550 8863	Rad	Wheel	10.0/75-15.3 12PR AW ET-25
5	550 8864	Rad	Wheel	340/55-16TL 6/161/205/B2
5	55010332	Rad	Wheel	6/161/205 10.0/75-15.3 AW ET-2
5	648 4182	Pendelstützrad	Depth wheel	E7 5/94/140
5	648 4213	Pendelstützrad	Depth wheel	E7 5/94/140-10.0/75
5	64810010	Pendelrad gedämpft	Depth wheel dampened	Juwel 7 6/161/205
5	64910001	Uni-Rad	Uni-wheel	gedämpft J7 6/161/205
5	64910003	Uni-Rad	Uni-wheel	hydr. J7 6/161/205
6	570 1764	Beleuchtungseinheit	Lighting unit	2x296x478 Rd. HI RE
6	570 1765	Beleuchtungseinheit	Lighting unit	2x296x478 Rd. HI LI
6	570 2086	Beleuchtungsanlage	Lighting equipment	Pflug
6	57010104	Beleuchtungseinheit	Lighting unit	2x296x478 Rd.HI RE
6	57010105	Beleuchtungseinheit	Lighting unit	2x296x478 Rd.HI LI
6	670 1674	Beleuchtungsanlage	Lighting equipment	BLA-1 PF/UNI 33,7x1580
6	670 1677	Beleuchtungsanlage	Lighting equipment	BLA-3 PF

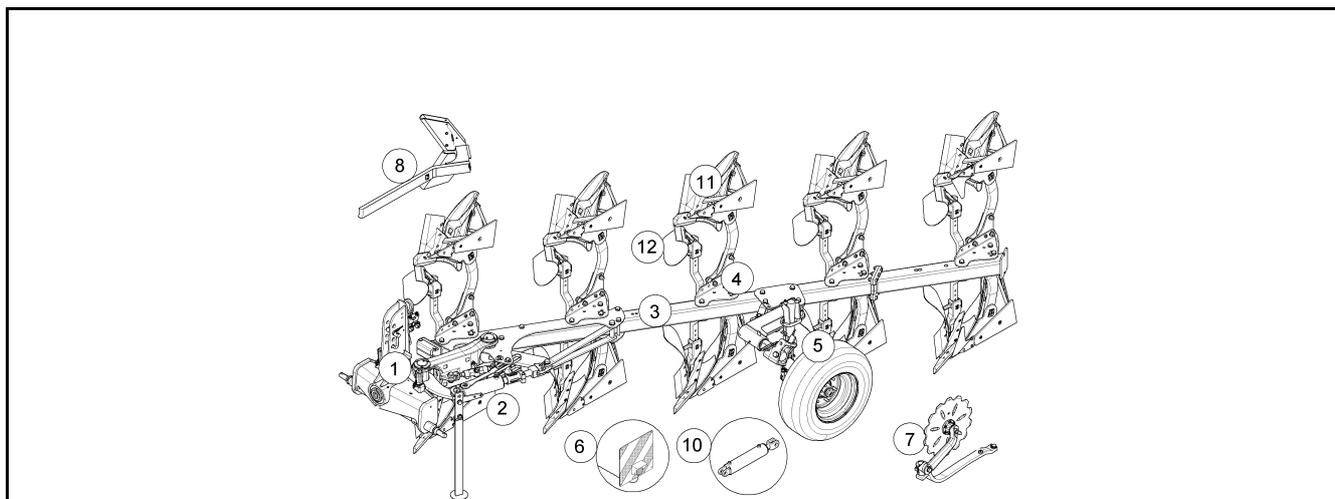

Pos.	Art.Nr.	Artikeltext / Description	Abmessung	
6	670 1708	seitl. Warntafel	Lateral warning board	SWT-1
6	67010192	Beleuchtungsanlage	Lighting equipment	BLA-4 PF/UNI
7	657 8001	Scheibensechhalm	Disc stalk	EurOpal 7 v.DE-L
7	657 8021	Scheibensechhalm	Disc stalk	E7 n.DE
7	657 9360	Secharm	Swinging arm	D500-G 375
7	657 9361	Secharm	Swinging arm	D500-Z 375
7	657 9362	Secharm	Swinging arm	D590-G 375
7	657 9363	Secharm	Swinging arm	D590-Z 375
7	657 9370	Secharm	Swinging arm	D500-G 250
7	657 9371	Secharm	Swinging arm	D500-Z 250
7	657 9372	Secharm	Swinging arm	D590-G 250
7	657 9373	Secharm	Swinging arm	D590-Z 250
7	657 9390	Secharm	Swinging arm	D500-G 371 F RE
7	657 9391	Secharm	Swinging arm	D500-G 371-F LI
7	657 9392	Secharm	Swinging arm	D500-Z 371-F RE
7	657 9393	Secharm	Swinging arm	D500-Z 371 F LI
7	657 9394	Secharm	Swinging arm	D590-G 371 F RE
7	657 9395	Secharm	Swinging arm	D590-G 371 F LI
7	657 9396	Secharm	Swinging arm	D590-Z 371 F RE
7	657 9397	Secharm	Swinging arm	D590-Z 371 F LI
8	622 2659	Mitnehmerarm	Attachment arm	E3V-HY
10	47510308	Schlauchpaket	Hose-assembly	Juwel Ra
10	47510309	Schlauchpaket	Hose-assembly	Juwel Ra,Pa
10	47510316	Schlauchpaket	Hose-assembly	Juwel Pa
10	47510563	Schlauchpaket	Hose-assembly	Juwel Ra+Vf
10	47510564	Schlauchpaket	Hose-assembly	Juwel Ra+Vf,Pa
10	47510567	Schlauchpaket	Hose-assembly	Juwel Vf
10	47510568	Schlauchpaket	Hose-assembly	Juwel Vf,Pa
10	575 2506	Umschaltzylinder	Change over ram	DZ80/40-236-D35 HPS-III-AR
10	575 2577	Dämpferzylinder	Ram	D50/25x210
10	57510254	Einschwenkzylinder	Swing-in ram	DZ90/45x220/680 D30
10	57510525	Hydraulikzylinder	Hydraulic ram	50/25-250-150
10	57510590	Memoryzylinder	Memory ram	ME-90/45x220/680
10	57510679	Dämpferzylinder	Ram	50/20x250/95 D20

INHALTSVERZEICHNIS / CONTENTS

Juwel 7M

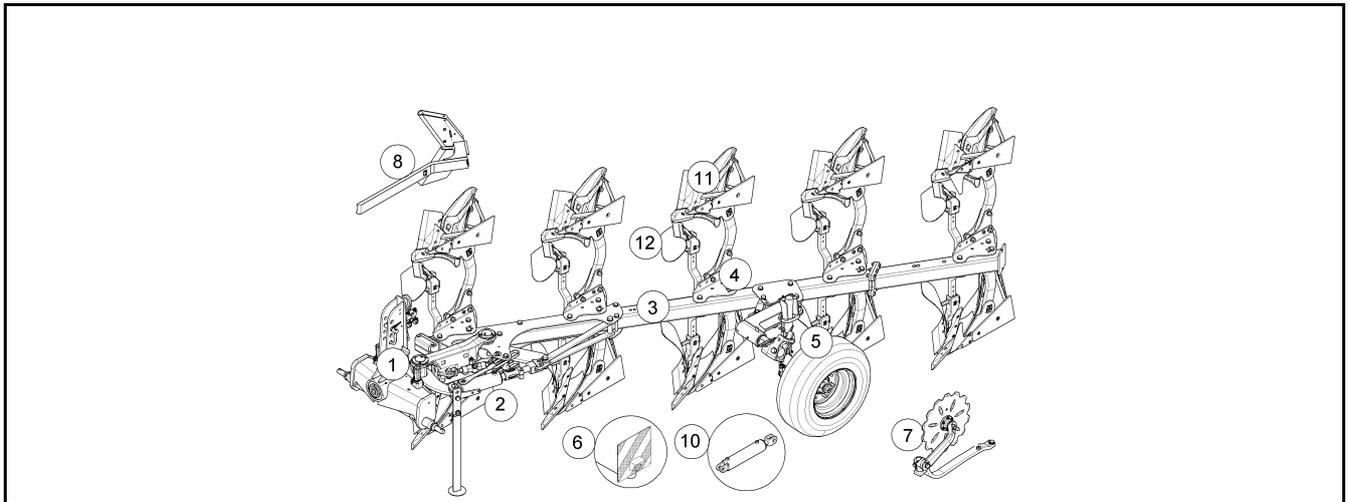

Pos.	Art.Nr.	Artikeltext / Description	Abmessung
10	57510850	Hy-anl. Unirad	HY-assembly depth+transp.wheel
10	57511086	Hydraulikzylinder	Hydraulic ram
10	57511094	Hy-anl. Unirad	HY-assembly depth+transp.wheel
10	57511095	Hydraulikanlage	Hydraulic assembly
10	57511096	Hydraulikanlage	Hydraulic assembly
10	57511097	Hydraulikanlage	Hydraulic assembly
10	57511113	Hy-anl. Unirad	HY-assembly depth+transp.wheel
10	67510252	Pflugdrehung	Plough turning
10	67510254	Hy-anl. Vorderf.+Rahmenschw.	HY-ass.fr.furr.+frame swing-in
10	67510264	Hydraulikanlage Mitnehmer	HY-assembly attachment arm
10	67510379	Hy-anl. Vorderfurcheinstell.	HY-assembl.front furr.adjustm.
10	67510390	Hy-anl. Vorderfurcheinstell.	HY-assembl.front furr.adjustm.
10	67510627	Halter	Holder
10	67510836	Hydraulikanlage	Hydraulic assembly
10	67510837	Hydraulikanlage	Hydraulic assembly
10	67510838	Hydraulikanlage	Hydraulic assembly
10	67510839	Hydraulikanlage	Hydraulic assembly
10	67510858	Hy-anl. Vorderf.+Rahmenschw.	HY-ass.fr.furr.+frame swing-in
10	67510859	Hydraulikanlage	Hydraulic assembly
10	67510861	Hydraulikanlage	Hydraulic assembly
10	67510862	Hydraulikanlage	Hydraulic assembly
10	67510863	Hydraulikanlage	Hydraulic assembly
10	67510864	Hydraulikanlage	Hydraulic assembly
11	56710002	Stützplatte	Buck plate
11	56710003	Stützplatte	Buck plate
11	657 4608	Untergrunddorn	Subsoiler
11	657 4609	Untergrunddorn	Subsoiler
11	657 4612	Untergrunddorn	Subsoiler
11	657 4613	Untergrunddorn	Subsoiler
11	66710076	Anlage mit Schrauben	Landside with bolt
11	66710077	Anlage mit Schrauben	Landside with bolt
11	699 5150	Körper	Body
11	699 5151	Körper	Body
11	699 5152	Körper	Body
			Juwel M
			ME090/45x0220-0660 D30 D30
			Juwel 7(T) 3+1/4-090
			Unirad Juwel 7(T) 4+1/5-090
			Unirad Juwel 7 (T) 3+1/4-100
			Unirad Juwel 7 (T) 4+1/5-100
			Juwel 7 M L
			D80 mech
			Juwel 7 M D90
			PA-J M
			Memory D90 Juwel 7 M
			Juwel 7 M D90
			Juwel 8 M D90
			Unirad Juwel 7 M(T X) 3+1/4-09
			Unirad Juwel 7M(T X) 4+1/5-090
			Unirad Juwel 7 M(T X) 3+1/4-10
			Unirad Juwel 7 M(T X) 4+1/5-10
			Juwel 7 M L D90
			Memory D90 Juwel 7 M L
			Unirad Juwel 7 M L 3+1/4-090
			Unirad Juwel 7 M L 4+1/5-090
			Unirad Juwel 7 M L 3+1/4-100
			Unirad Juwel 7 M L 4+1/5-100
			183x162x10 M16 RE
			183x162x10 M16 LI
			UD6-80 RE
			UD6-80 LI
			DMUD-1 RE
			DMUD-1 LI
			DMV2 RE
			DMV2 LI
			DM_CS40
			DM_CS50
			DM_W40

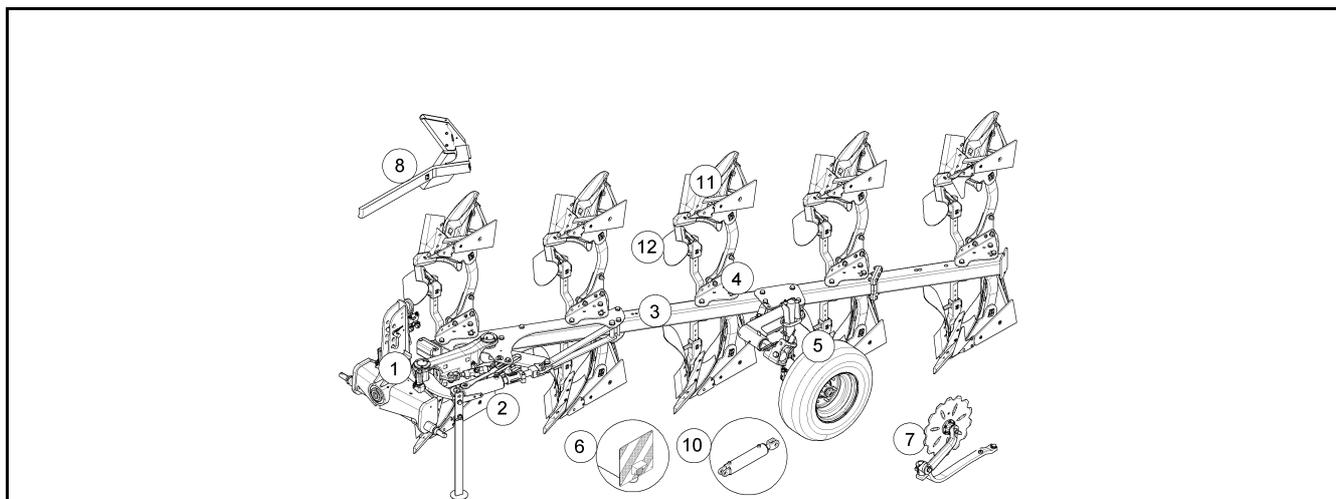

Pos.	Art.Nr.	Artikeltext / Description		Abmessung
11	699 5153	Körper	Body	DM_W52
11	699 5154	Körper	Body	DM_CS40_KU
11	699 5155	Körper	Body	DM_CS40_KU/ST
11	699 5156	Körper	Body	DMS_CS40
11	699 5157	Körper	Body	DMS_CS50
11	699 6000	Körperhalschrauben	Bolts for leg	Dural
12	663 8750	Düngereinlegerhalm	Skim stalk	K--220/260
12	663 8752	Düngereinlegerhalm	Skim stalk	M--220/260
12	663 8762	Düngereinlegerhalm	Skim stalk	M-V260
12	663 8764	Düngereinlegerhalm	Skim stalk	L--220/260
12	663 8770	Düngereinlegerhalm	Skim stalk	J1 50x30-220/260 H800-850
12	663 8781	Düngereinlegerhalm	Skim stalk	KW-220
12	663 8783	Düngereinlegerhalm	Skim stalk	MW-220
12	66310003	Düngereinlegerhalm	Skim stalk	J2 50x30-220/260 H800
12	66310004	Düngereinlegerhalm	Skim stalk	J3 50x30-220/260 H900
12	66310007	Düngereinlegerhalm	Skim stalk	J2S 50x30-220/260 H800
12	66310008	Düngereinlegerhalm	Skim stalk	J1S 50x30-220/260 H800-850
12	66310009	Düngereinlegerhalm	Skim stalk	J3S 50x30-220/260 H900
12	66310013	Düngereinlegerhalm	Skim stalk	LW-220
12	66310014	Düngereinlegerhalm	Skim stalk	KS-220/260
12	66310015	Düngereinlegerhalm	Skim stalk	MS-220/260
12	66310016	Düngereinlegerhalm	Skim stalk	LS-220/260
12	699 5520	Düngereinleger	Skimmer	FL50x30-10
12	699 5522	Düngereinleger Wurfwinkelverst	Skimmer	FL50x30
12	69910389	Düngereinleger	Skimmer	FL50x30-G

Oberlenkerbolzen kpl./Top link pin, cpl.	1
---	----------

Juwel 7M	313 7911
-----------------	-----------------

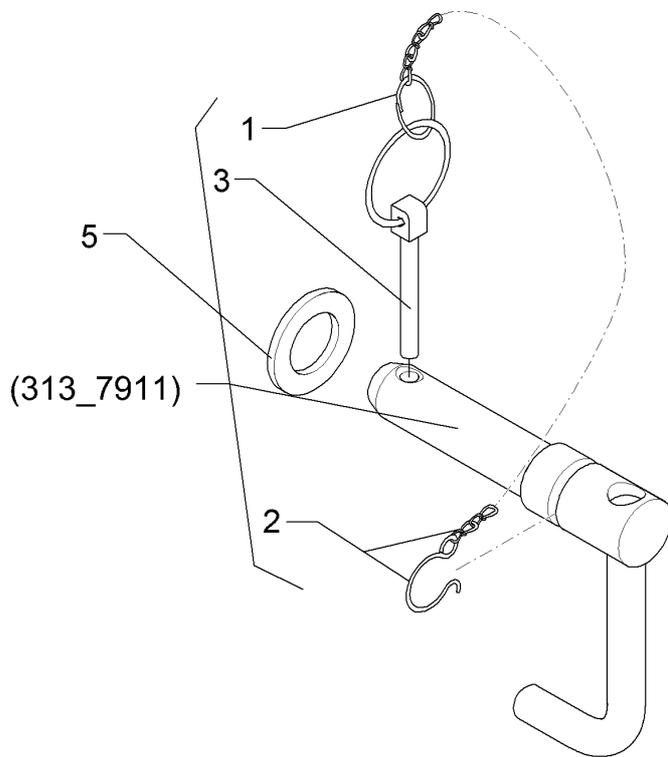

01.18

Pos.	Art.Nr.	Stck.	Artikeltext / Description	Abmessung
1	305 8545	1	Sicherungsring	Retaining ring
2	305 8560	1	Federsicherung	Securing clip
3	311 9315	1	Klappstift mit Bohrung	Securing pin
4	313 7910	1	Oberlenkerbolzen	Top link pin
5	305 6283	1	Scheibe	Washer
				3x30-35x1,25 Zn
				D3,6/D21-460mm-Zn
				8x42 DIN11023
				KAT2G
				D25,4/31,7x158 Zn
				B28 DIN125

Oberlenkerbolzen kpl./Top link pin, cpl.	1
---	----------

Juwel 7M	313 7921
-----------------	-----------------

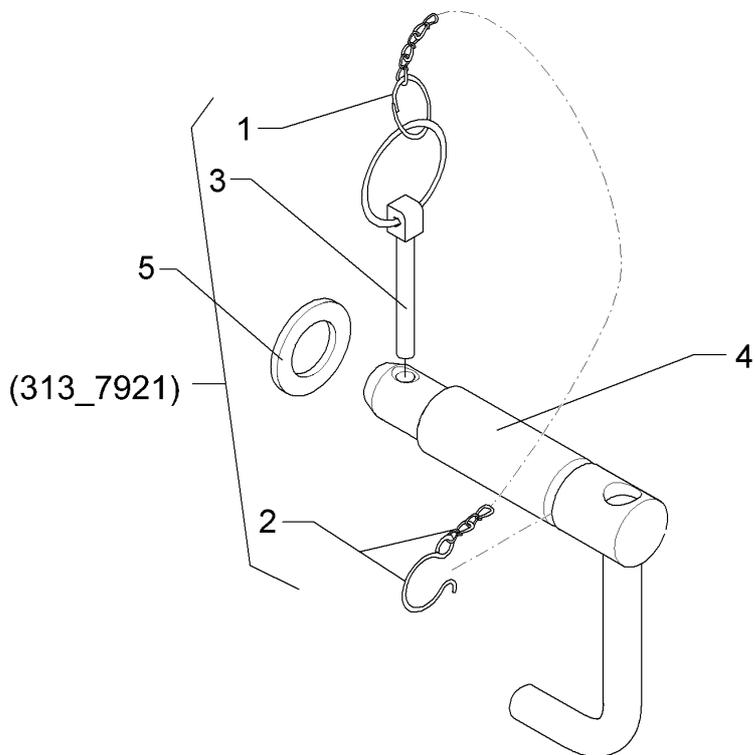

01.18

Pos.	Art.Nr.	Stck.	Artikeltext / Description	Abmessung	
1	305 8545	1	Sicherungsring	Retaining ring	3x30-35x1,25 Zn
2	305 8560	1	Federsicherung	Securing clip	D3,6/D21-460mm-Zn
3	311 9315	1	Klappstift mit Bohrung	Securing pin	8x42 DIN11023
4	313 7920	1	Oberlenkerbolzen	Top link pin	KAT3G D31,7/25,4x160 Zn
5	305 6283	1	Scheibe	Washer	B28 DIN125

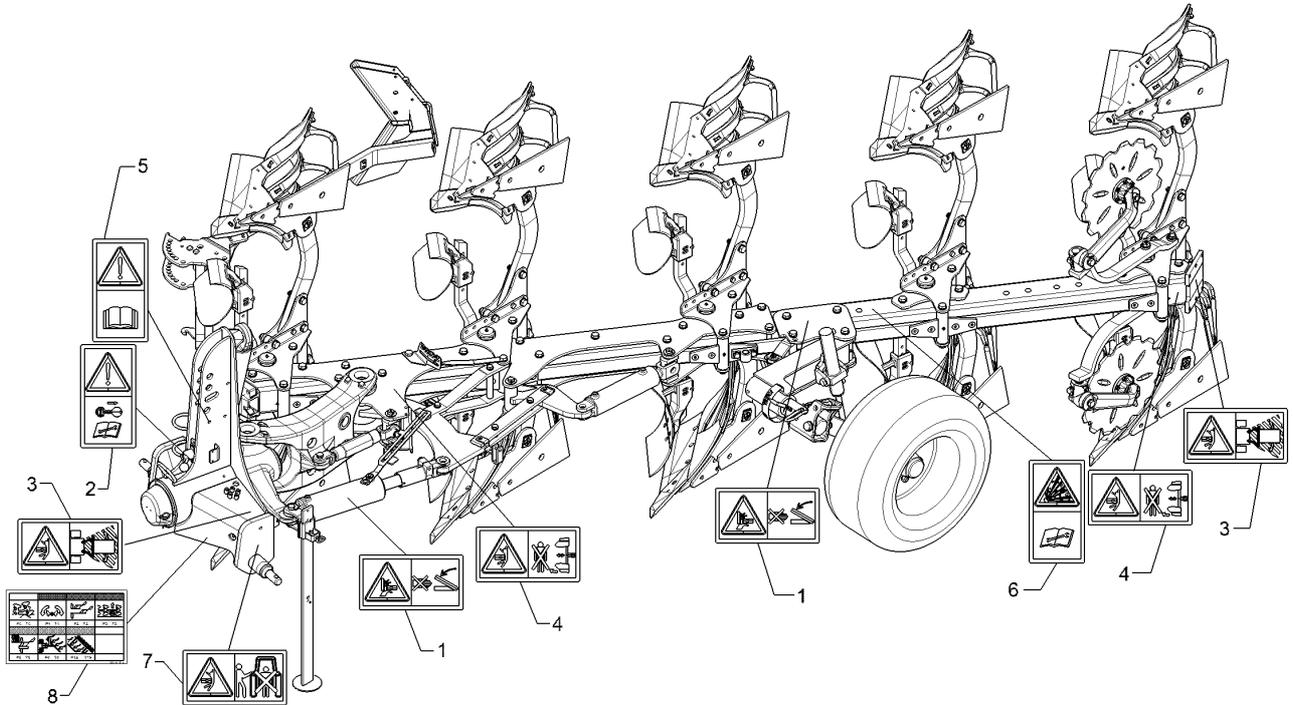

01.18

Pos.	Art.Nr.	Stck.	Artikeltext / Description		Abmessung
1	390 0506	2	Aufkleber Warnbildzeichen	Warning Label	Quetschgefahr QF
2	390 0509	1	Aufkleber Warnbildzeichen	Warning Label	Motor abstellen
3	390 0510	2	Aufkleber Warnbildzeichen	Warning Label	Schwenkbereich QF
4	390 0520	2	Aufkleber Warnbildzeichen	Warning Label	Arbeitsbereich QF
5	390 0555	1	Aufkleber Betriebsanl. lesen	Label Warning!	ISO HF 61 x 115
6	390 0591	1	Aufkleber Druckspeicher	Label	-
7	390 0629	1	Aufkleber Hubbereich	Label	QF 115 x 61
8	39010115	1	Aufkleber HY-Anschlüsse	Label	Juwel 135x83 P0-P15

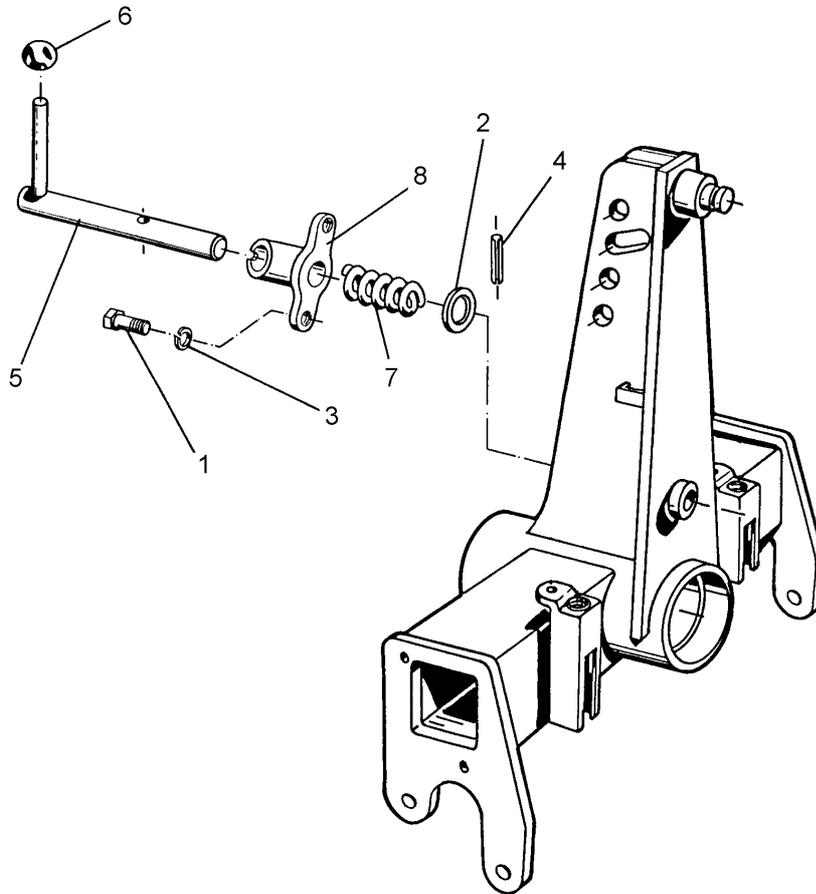

01.18

Pos.	Art.Nr.	Stck.	Artikeltext / Description		Abmessung
1	301 5004	2	Sechskantschraube	Hexagon bolt	M10x30-8.8 Zn DIN933
2	305 6222	1	Passscheibe	Shim	26x37x1,0 DIN988 Zn
3	305 8696	2	Scheibe	Washer	A10,5 DIN125-St Zn
4	309 6072	1	Spannhülse	Expansion bush	8x40-DIN1481 Zn
5	313 8290	1	Verriegelungsbolzen	Locking pin	D25x260 Zn
6	321 2575	1	Kugel konisch	Ball	D40 D12
7	329 8176	1	Druckfeder	Compression spring	2,5x32x110 DIN2098
8	433 9146	1	Konsole	Bracket	D26/45x70

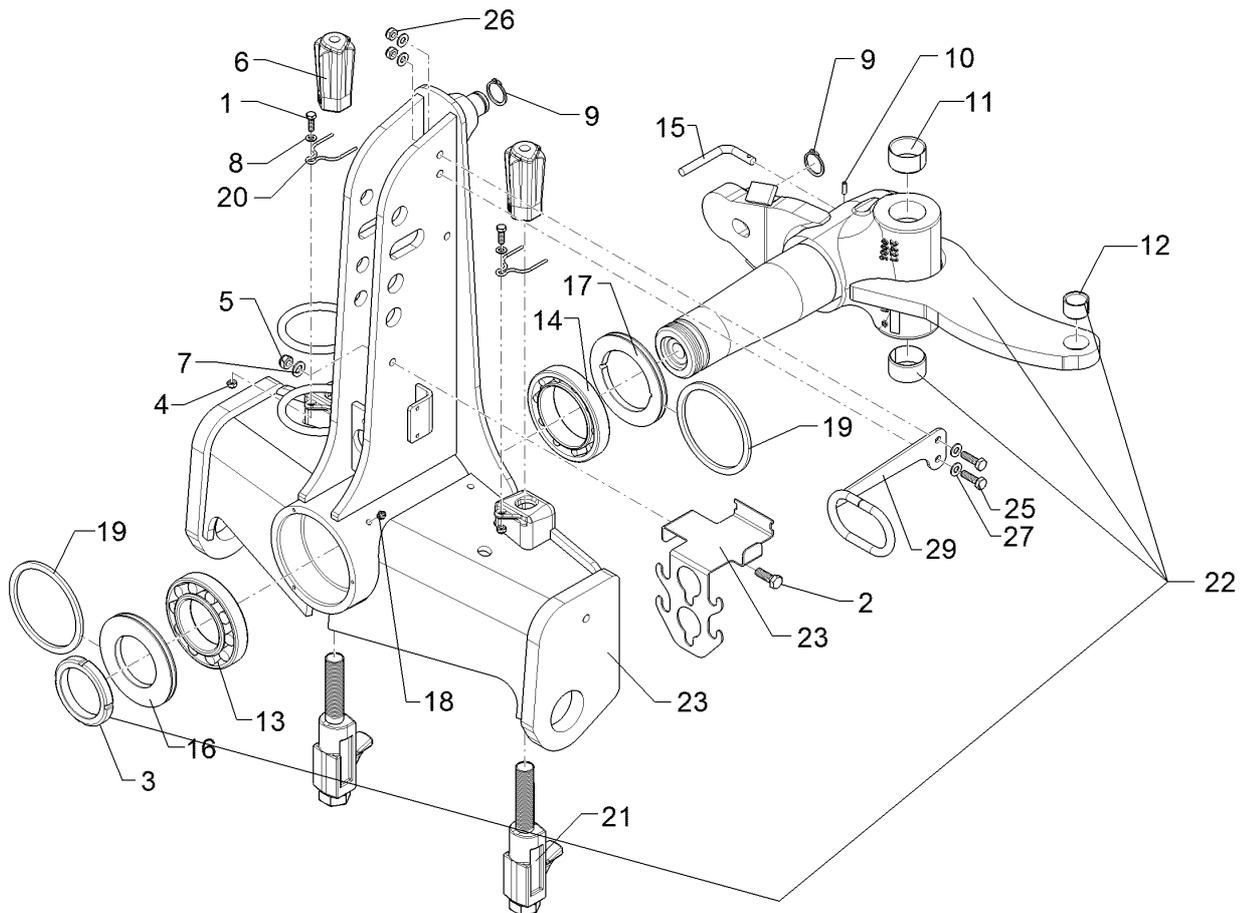

01.18

Pos.	Art.Nr.	Stck.	Artikeltext / Description		Abmessung
1	301 7280	2	Sechskantschraube	Hexagon bolt	M8x25-8.8 Zn DIN933
2	301 7334	1	Sechskantschraube	Hexagon bolt	M12x35-8.8 Zn DIN933
3	303 0346	1	Nutmutter	Grooved nut	M85x2 MK17 Zn
4	303 0932	2	Sicherungsmutter	Selflocking nut	NM8-8 Zn DIN985
5	303 0934	1	Sicherungsmutter	Selflocking nut	NM12-8 Zn DIN985
6	303 8960	2	Hutmutter	Cap nut	M27-SW46x118
7	305 8580	1	Scheibe	Washer	13/24x2,5 St-Zn DIN125
8	305 8694	2	Scheibe	Washer	A8,4 DIN125-St Zn
9	305 8873	2	Sicherungsring	Retaining ring	35x2,5 DIN471
10	309 6046	1	Spannhülse	Expansion bush	6x20-DIN1481 Zn
11	317 2025	2	Einspannbuchse mit Presssitz	Expansion bush	EG50/55x30
12	317 3417	1	Einspannbuchse mit Presssitz	Expansion bush	EG30/38x25
13	319 9095	1	Kegelrollenlager	Tapered roller bearing	30217 D150/85x30,5
14	319 9219	1	Kegelrollenlager	Tapered roller bearing	32020X D150/100x32
15	32110018	1	Hebel	Lever	D12x173 1xD6 GEB2x90GRD Zn
16	323 0060	1	Dichtscheibe	Seal washer	D149,5/100x12 2xd8 Zn
17	323 0062	1	Dichtscheibe mit Nut	Seal washer	D149,5/85x12 Zn
18	323 6348	1	Schmiernippel	Grease nipple	AM10x1 DIN71412
19	323 7970	2	Filzring	Felt ring	D150/130x6
20	329 8620	2	Klammer	Clamp	D4x70-46 Zn

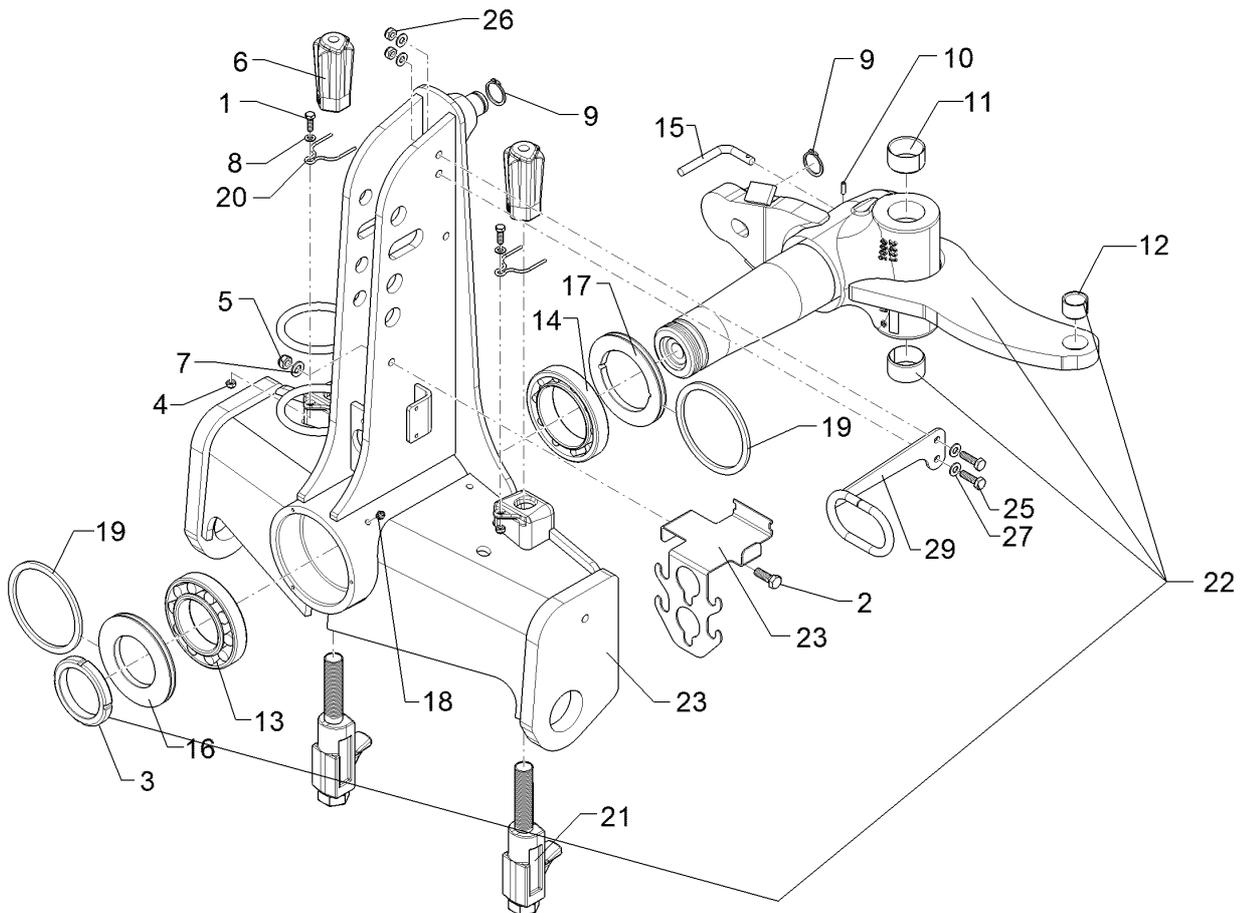

01.18

Pos.	Art.Nr.	Stck.	Artikeltext / Description	Abmessung	
21	433 9201	2	Anschlag	Stop	D75/90-M27
22	53310005	1	Wendeachse	Turning axle	G100
23	43310006	1	Turm	Headstock	M100
24	475 4421	1	Schlauchhalter	Hose carrier	S6 2,5x213x322,5 4xGEB90GRD Zn
25	301 7308	2	Sechskantschraube	Hexagon bolt	M10x35-8.8 Zn DIN933
26	303 0933	2	Sicherungsmutter	Selflocking nut	NM10-8 DIN985 Zn
27	305 8696	4	Scheibe	Washer	A10,5 DIN125-St Zn
29	475 4404	1	Schlauchhalter oben	Hose carrier rear	SDO

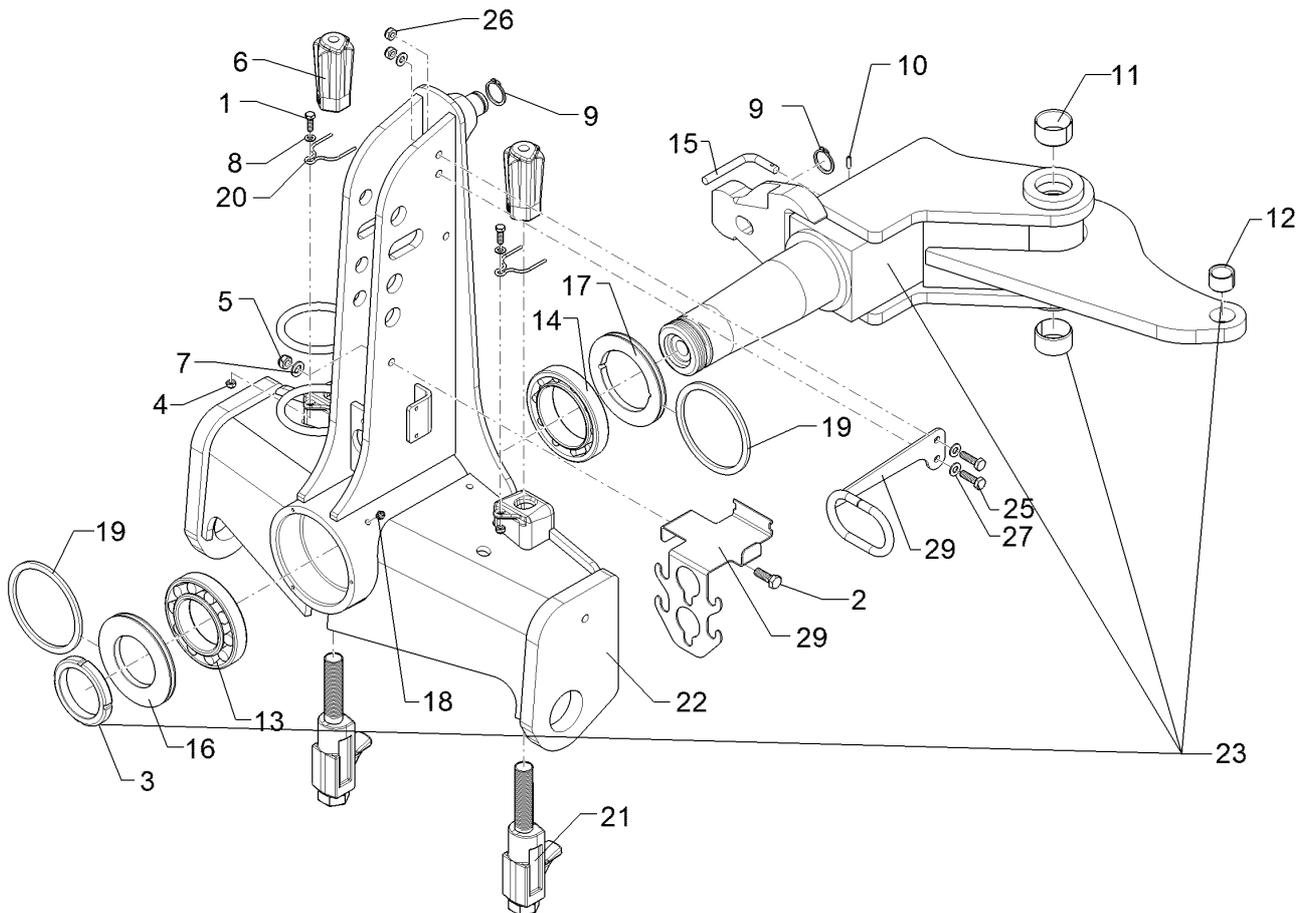

01.18

Pos.	Art.Nr.	Stck.	Artikeltext / Description		Abmessung
1	301 7280	2	Sechskantschraube	Hexagon bolt	M8x25-8.8 Zn DIN933
2	301 7334	1	Sechskantschraube	Hexagon bolt	M12x35-8.8 Zn DIN933
3	303 0346	1	Nutmutter	Grooved nut	M85x2 MK17 Zn
4	303 0932	2	Sicherungsmutter	Selflocking nut	NM8-8 Zn DIN985
5	303 0934	1	Sicherungsmutter	Selflocking nut	NM12-8 Zn DIN985
6	303 8960	2	Hutmutter	Cap nut	M27-SW46x118
7	305 8580	1	Scheibe	Washer	13/24x2,5 St-Zn DIN125
8	305 8694	2	Scheibe	Washer	A8,4 DIN125-St Zn
9	305 8873	2	Sicherungsring	Retaining ring	35x2,5 DIN471
10	309 6046	1	Spannhülse	Expansion bush	6x20-DIN1481 Zn
11	317 2025	2	Einspannbuchse mit Presssitz	Expansion bush	EG50/55x30
12	317 3417	1	Einspannbuchse mit Presssitz	Expansion bush	EG30/38x25
13	319 9095	1	Kegelrollenlager	Tapered roller bearing	30217 D150/85x30,5
14	319 9219	1	Kegelrollenlager	Tapered roller bearing	32020X D150/100x32
15	32110018	1	Hebel	Lever	D12x173 1xD6 GEB2x90GRD Zn
16	323 0060	1	Dichtscheibe	Seal washer	D149,5/100x12 2xd8 Zn
17	323 0062	1	Dichtscheibe mit Nut	Seal washer	D149,5/85x12 Zn
18	323 6348	1	Schmiernippel	Grease nipple	AM10x1 DIN71412
19	323 7970	2	Filzring	Felt ring	D150/130x6
20	329 8620	2	Klammer	Clamp	D4x70-46 Zn

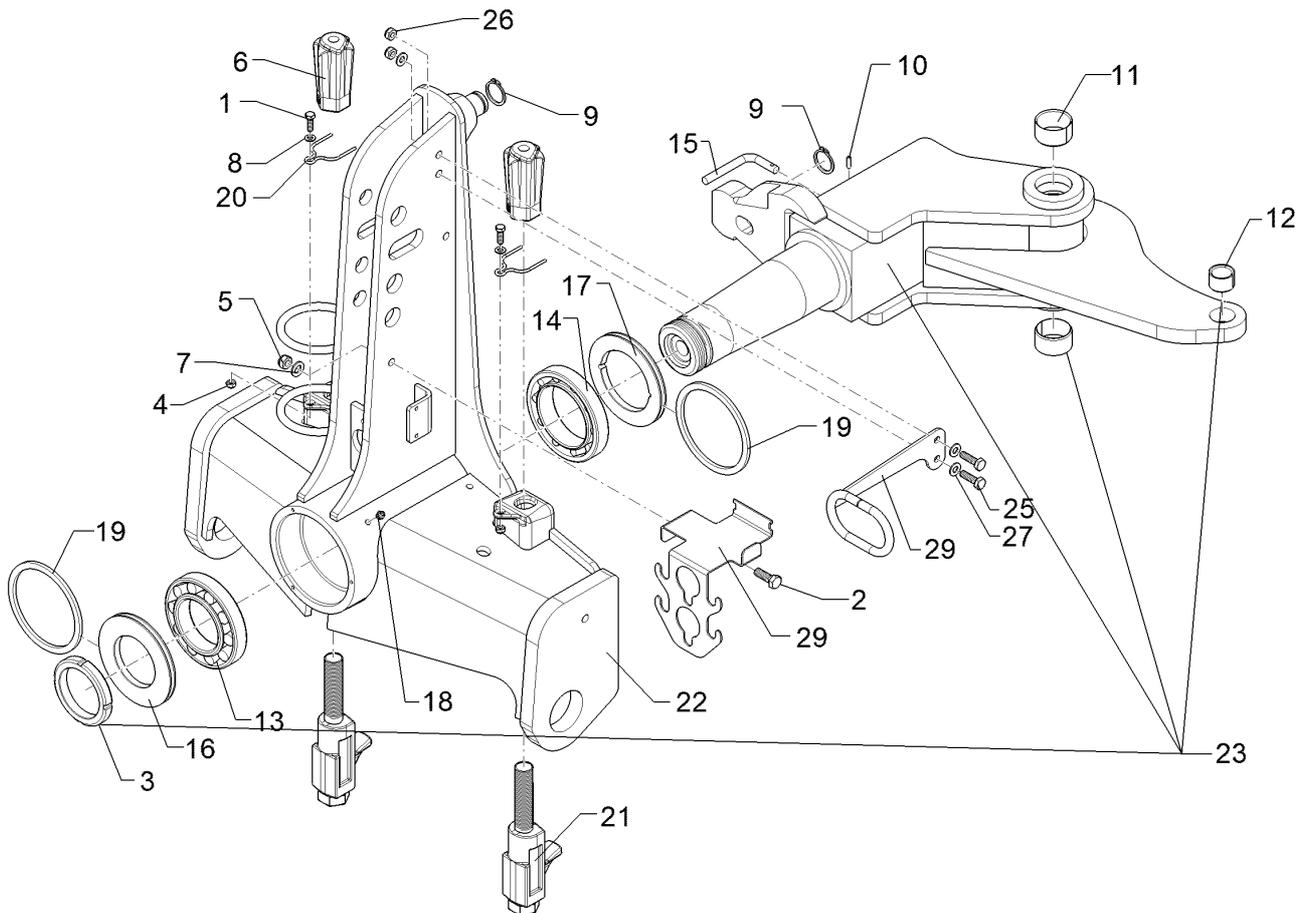

01.18

Pos.	Art.Nr.	Stck.	Artikeltext / Description	Abmessung	
21	433 9201	2	Anschlag	Stop	D75/90-M27
22	43310006	1	Turm	Headstock	M100
23	53310007	1	Wendeachse	Turning axle	G100L
24	475 4421	1	Schlauchhalter	Hose carrier	S6 2,5x213x322,5 4xGEB90GRD Zn
25	301 7308	2	Sechskantschraube	Hexagon bolt	M10x35-8.8 Zn DIN933
26	303 0933	2	Sicherungsmutter	Selflocking nut	NM10-8 DIN985 Zn
27	305 8696	4	Scheibe	Washer	A10,5 DIN125-St Zn
29	475 4404	1	Schlauchhalter oben	Hose carrier rear	SDO

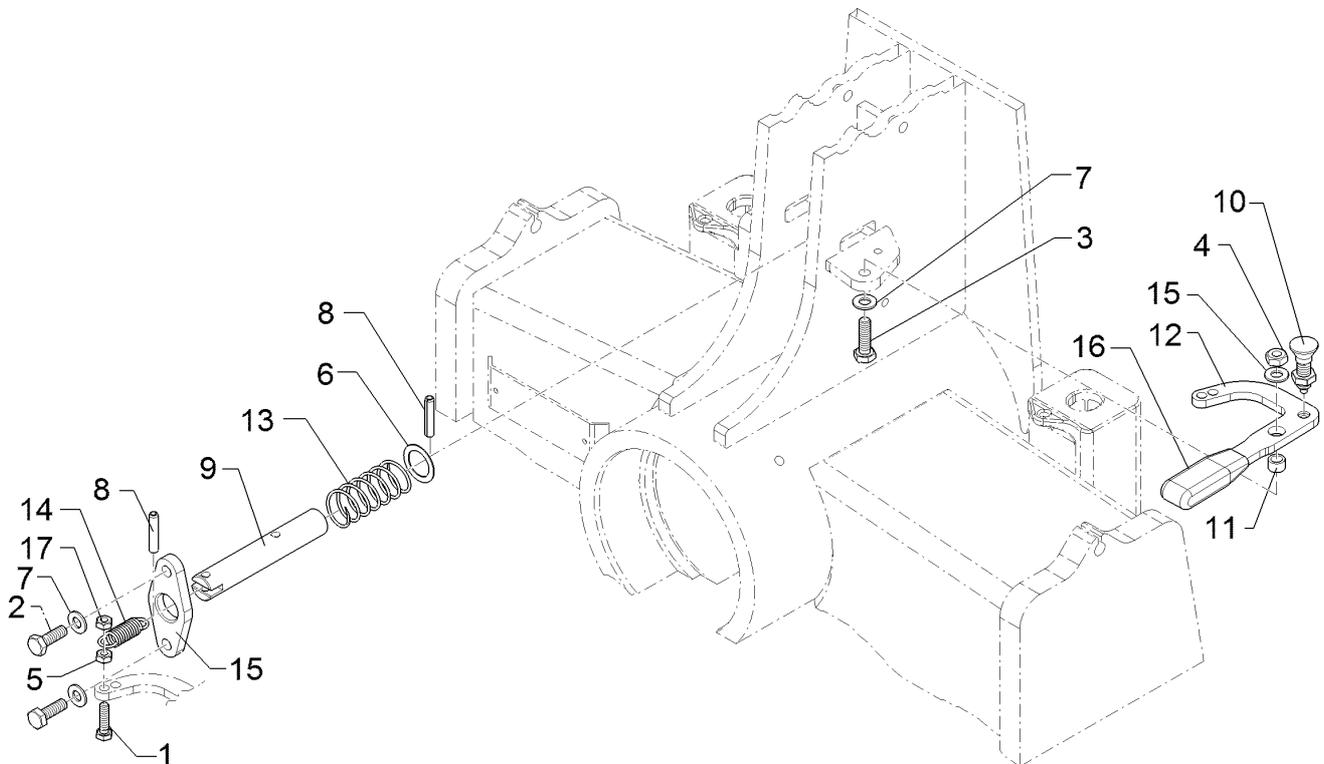

01.18

Pos.	Art.Nr.	Stck.	Artikeltext / Description		Abmessung
1	301 3066	1	Sechskantschraube	Hexagon bolt	M8x30-8.8 Zn DIN933
2	301 5004	2	Sechskantschraube	Hexagon bolt	M10x30-8.8 Zn DIN933
3	301 7308	1	Sechskantschraube	Hexagon bolt	M10x35-8.8 Zn DIN933
4	303 0933	1	Sicherungsmutter	Selflocking nut	NM10-8 DIN985 Zn
5	303 1011	1	Sechskantmutter	Hexagon nut	M8 DIN934-8 Zn
6	305 6222	1	Passscheibe	Shim	26x37x1,0 DIN988 Zn
7	305 8696	4	Scheibe	Washer	A10,5 DIN125-St Zn
8	309 6072	2	Spannhülse	Expansion bush	8x40-DIN1481 Zn
9	31310121	1	Bolzen	Pin	D25x142 2xD8
10	31310122	1	Rastbolzen	Stop bolt	M12x1,5 D6
11	31710116	1	Buchse	Bush	D15/10,2x9,5 Zn
12	32110126	1	Handgriff	Handle	GN910.5-440 rd
13	329 8176	1	Druckfeder	Compression spring	2,5x32x110 DIN2098
14	329 8495	1	Zugfeder	Spring	2,5x12x75
15	43310020	1	Blech	Plate	D26/45x105 2xD11
16	43310021	1	Verriegelungshebel	Locking lever	8x107x160 M12x1,5 D15,2 2xD9
17	303 0932	1	Sicherungsmutter	Selflocking nut	NM8-8 Zn DIN985

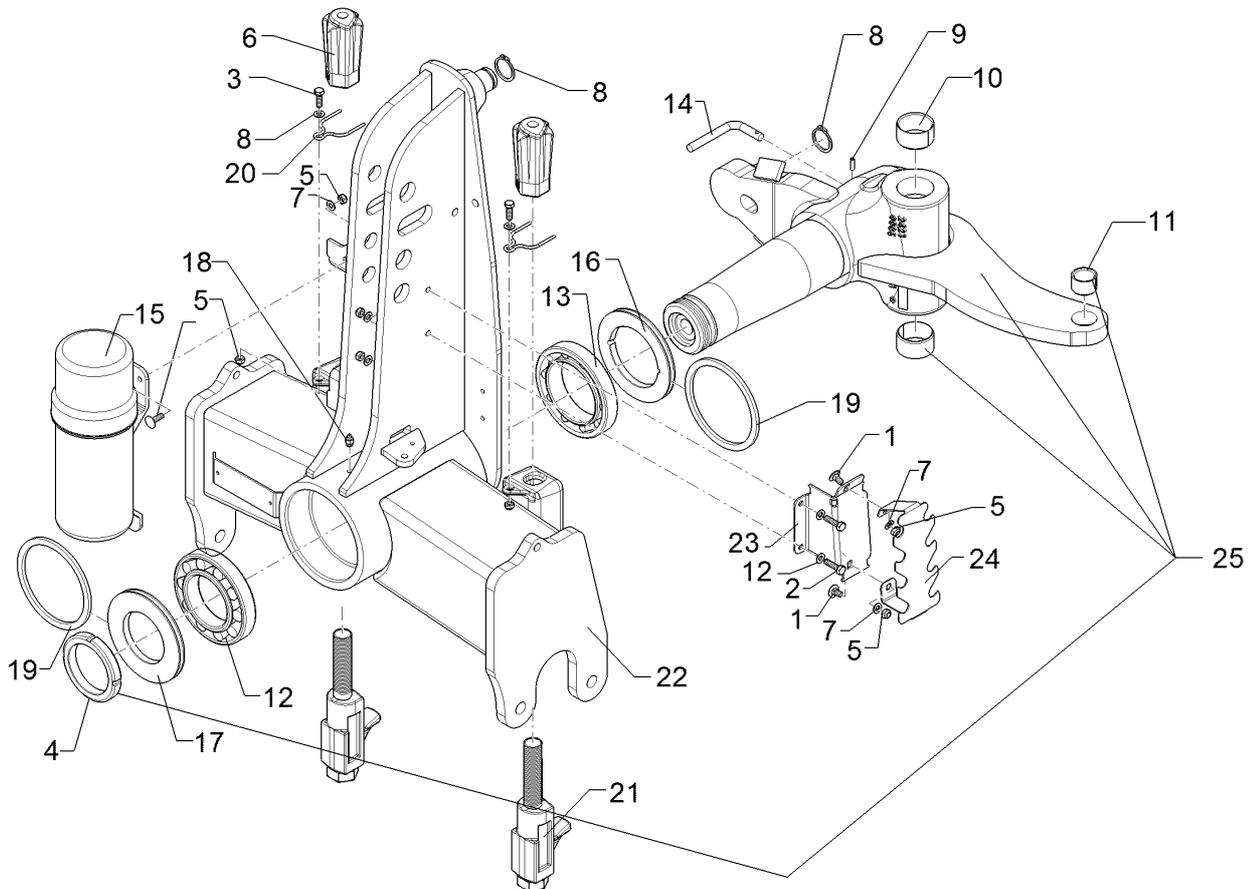

01.18

Pos.	Art.Nr.	Stck.	Artikeltext / Description		Abmessung
1	301 1120	2	Flachrundschraube	Saucer-head screw	M8x16-4.6 Zn DIN603
2	301 3066	2	Sechskantschraube	Hexagon bolt	M8x30-8.8 Zn DIN933
3	301 7280	4	Sechskantschraube	Hexagon bolt	M8x25-8.8 Zn DIN933
4	303 0346	1	Nutmutter	Grooved nut	M85x2 MK17 Zn
5	303 0932	8	Sicherungsmutter	Selflocking nut	NM8-8 Zn DIN985
6	303 8960	2	Hutmutter	Cap nut	M27-SW46x118
7	305 8694	14	Scheibe	Washer	A8,4 DIN125-St Zn
8	305 8873	2	Sicherungsring	Retaining ring	35x2,5 DIN471
9	309 6046	1	Spannhülse	Expansion bush	6x20-DIN1481 Zn
10	317 2025	2	Einspannbuchse mit Presssitz	Expansion bush	EG50/55x30
11	317 3417	1	Einspannbuchse mit Presssitz	Expansion bush	EG30/38x25
12	319 9095	1	Kegelrollenlager	Tapered roller bearing	30217 D150/85x30,5
13	319 9219	1	Kegelrollenlager	Tapered roller bearing	32020X D150/100x32
14	32110018	1	Hebel	Lever	D12x173 1xD6 GEB2x90GRD Zn
15	32110127	1	Dokumentenbehälter	Documents box	D140x363
16	323 0060	1	Dichtscheibe	Seal washer	D149,5/100x12 2xd8 Zn
17	323 0062	1	Dichtscheibe mit Nut	Seal washer	D149,5/85x12 Zn
18	323 6348	1	Schmiernippel	Grease nipple	AM10x1 DIN71412
19	323 7970	2	Filzring	Felt ring	D150/130x6
20	329 8620	2	Klammer	Clamp	D4x70-46 Zn

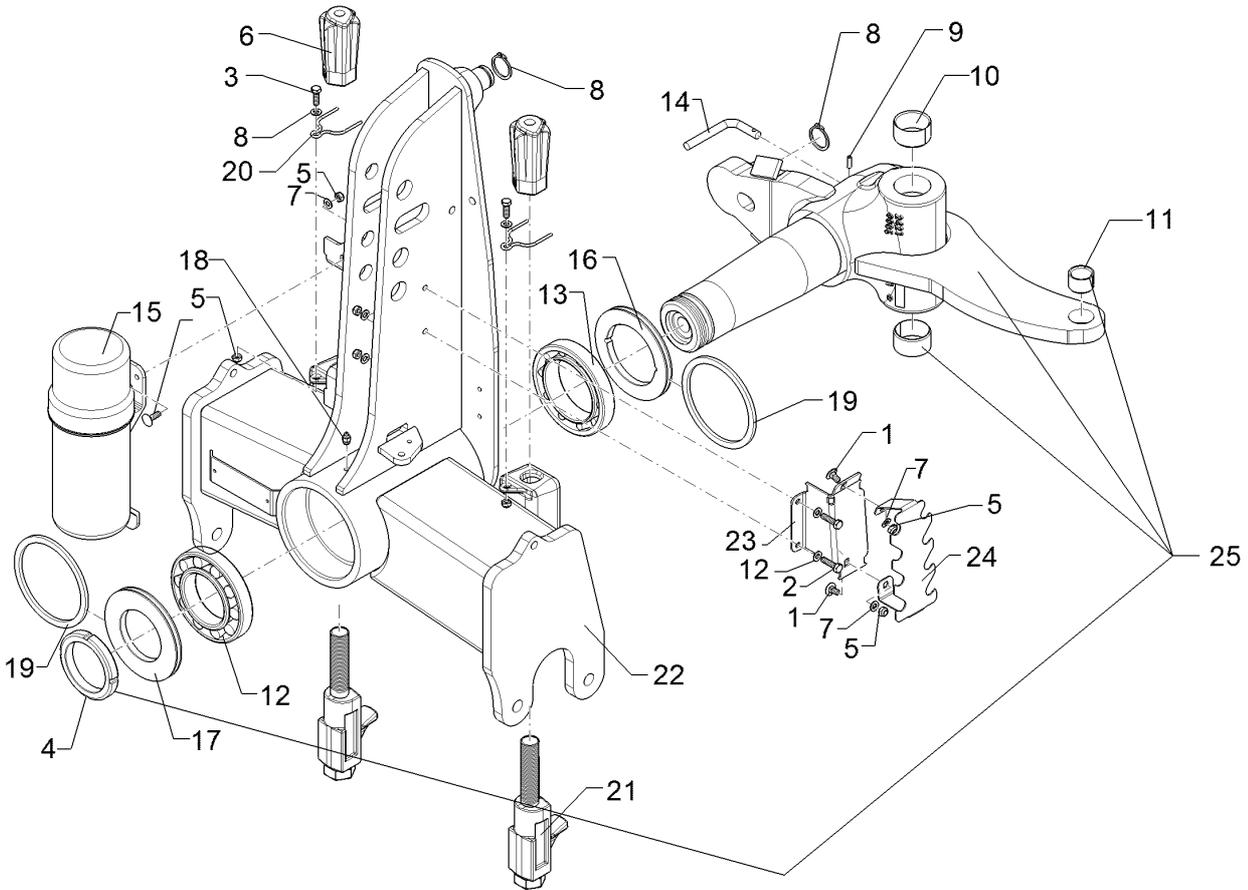

01.18

Pos.	Art.Nr.	Stck.	Artikeltext / Description	Abmessung	
21	433 9201	2	Anschlag	Stop	D75/90-M27
22	43310030	1	Pflugturm	Headstock	M100
23	47510863	1	Schlauchführung	Hose guiding	171x93x70,8 2xD9
24	47510864	1	Schlauchhalter	Hose carrier	193x85x66
25	53310005	1	Wendeachse	Turning axle	G100

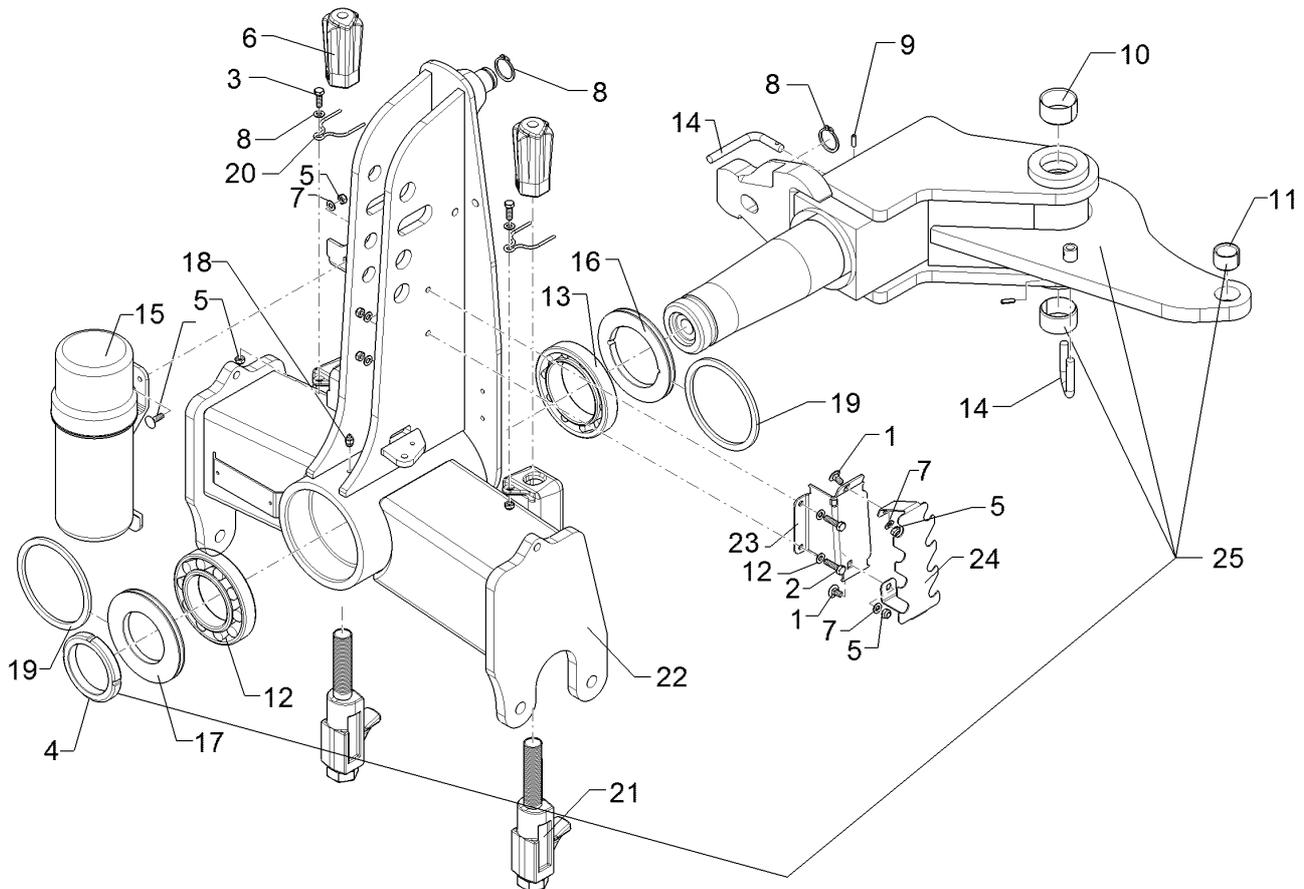

01.18

Pos.	Art.Nr.	Stck.	Artikeltext / Description		Abmessung
1	301 1120	2	Flachrundschraube	Saucer-head screw	M8x16-4.6 Zn DIN603
2	301 3066	2	Sechskantschraube	Hexagon bolt	M8x30-8.8 Zn DIN933
3	301 7280	4	Sechskantschraube	Hexagon bolt	M8x25-8.8 Zn DIN933
4	303 0346	1	Nutmutter	Grooved nut	M85x2 MK17 Zn
5	303 0932	8	Sicherungsmutter	Selflocking nut	NM8-8 Zn DIN985
6	303 8960	2	Hutmutter	Cap nut	M27-SW46x118
7	305 8694	14	Scheibe	Washer	A8,4 DIN125-St Zn
8	305 8873	2	Sicherungsring	Retaining ring	35x2,5 DIN471
9	309 6046	2	Spannhülse	Expansion bush	6x20-DIN1481 Zn
10	317 2025	2	Einspannbuchse mit Presssitz	Expansion bush	EG50/55x30
11	317 3417	1	Einspannbuchse mit Presssitz	Expansion bush	EG30/38x25
12	319 9095	1	Kegelrollenlager	Tapered roller bearing	30217 D150/85x30,5
13	319 9219	1	Kegelrollenlager	Tapered roller bearing	32020X D150/100x32
14	32110018	2	Hebel	Lever	D12x173 1xD6 GEB2x90GRD Zn
15	32110127	1	Dokumentenbehälter	Documents box	D140x363
16	323 0060	1	Dichtscheibe	Seal washer	D149,5/100x12 2xd8 Zn
17	323 0062	1	Dichtscheibe mit Nut	Seal washer	D149,5/85x12 Zn
18	323 6348	1	Schmiernippel	Grease nipple	AM10x1 DIN71412
19	323 7970	2	Filzring	Felt ring	D150/130x6
20	329 8620	2	Klammer	Clamp	D4x70-46 Zn

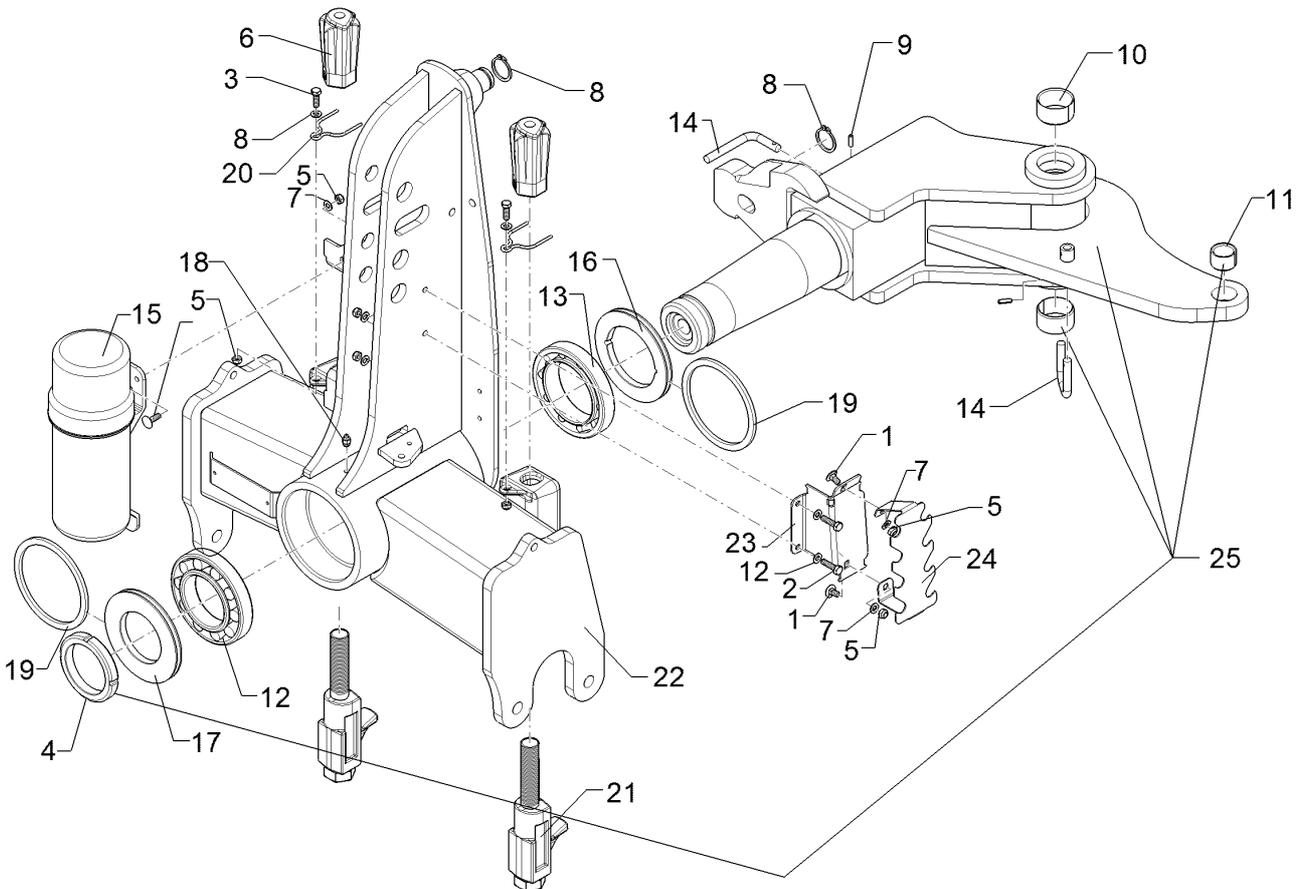

01.18

Pos.	Art.Nr.	Stck.	Artikeltext / Description	Abmessung	
21	433 9201	2	Anschlag	Stop	D75/90-M27
22	43310030	1	Pflugturm	Headstock	M100
23	47510863	1	Schlauchführung	Hose guiding	171x93x70,8 2xD9
24	47510864	1	Schlauchhalter	Hose carrier	193x85x66
25	53310007	1	Wendeachse	Turning axle	G100L

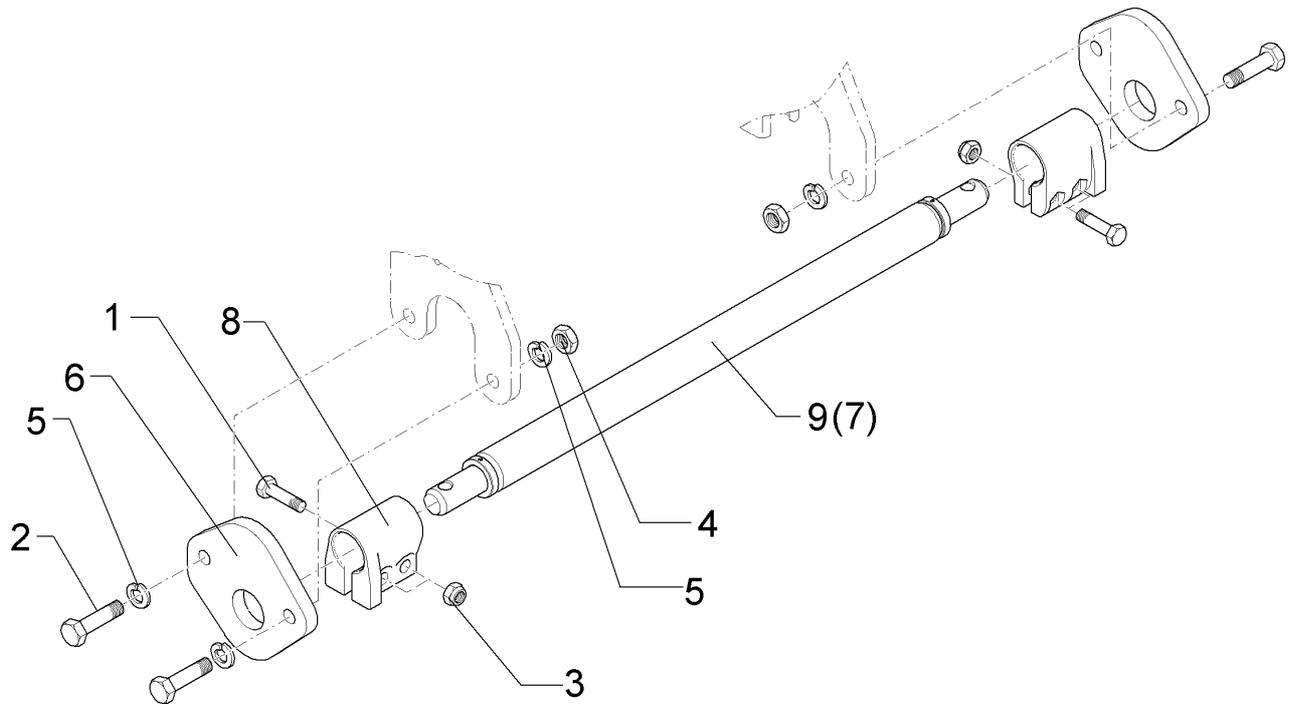

01.18

Pos.	Art.Nr.	Stck.	Artikeltext / Description		Abmessung
1	301 3868	4	Sechskantschraube	Hexagon bolt	M16x65-8.8 Zn DIN931-A
2	301 5390	4	Sechskantschraube spz.	Hexagon bolt	M20x65-12.9 Zn
3	303 0935	4	Sicherungsmutter	Selflocking nut	NM16-8 Zn DIN985
4	303 0978	4	Sechskantmutter	Hexagon nut	M20 DIN934-8 Zn
5	305 6012	8	Scheibe	Washer	21 ISO7089 Zn
6	461 6060	2	Schienenplatte	Plate	20x199x212 1xD55,7
7	461 7917	1	Schienenwelle	Drawbar	D55x970 L2 Z2
8	461 9892	2	Sperrstück	Stop	D55x100 2xD18
9	46110013	1	Zugschiene	Cross shaft	D55x970 L2 Z2 HÜ

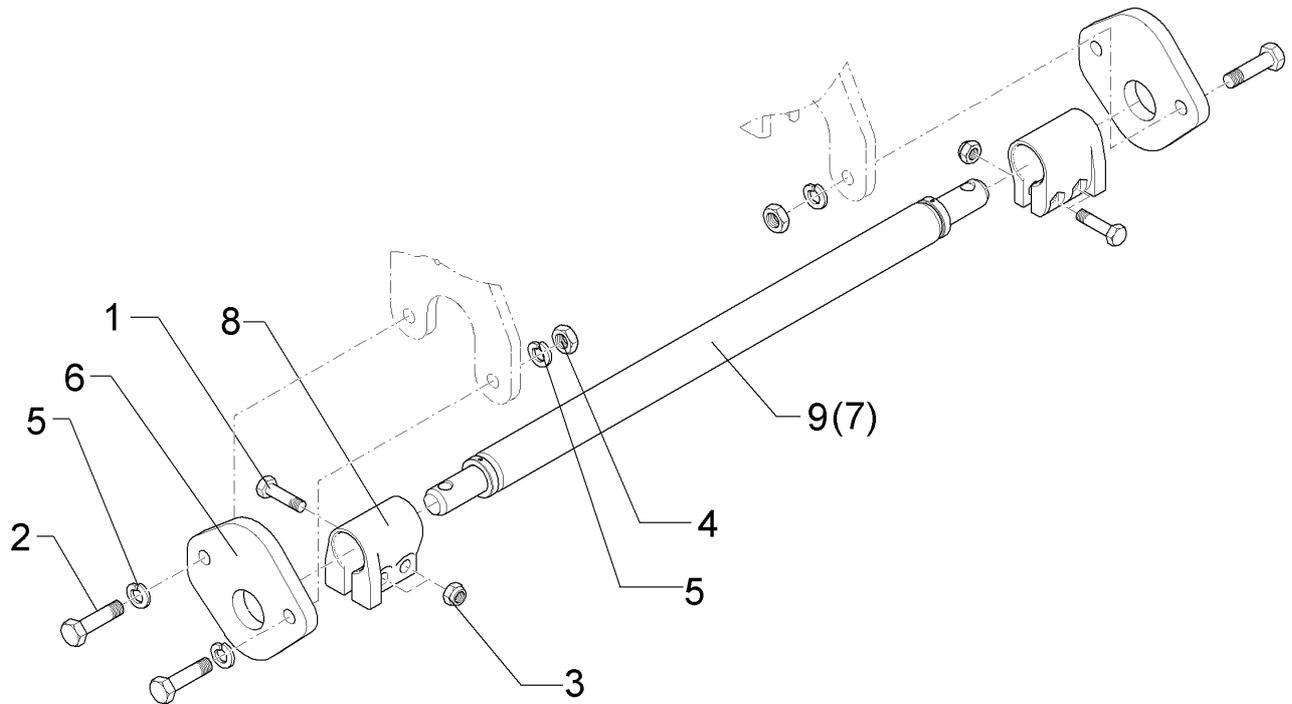

01.18

Pos.	Art.Nr.	Stck.	Artikeltext / Description		Abmessung
1	301 3868	4	Sechskantschraube	Hexagon bolt	M16x65-8.8 Zn DIN931-A
2	301 5390	4	Sechskantschraube spz.	Hexagon bolt	M20x65-12.9 Zn
3	303 0935	4	Sicherungsmutter	Selflocking nut	NM16-8 Zn DIN985
4	303 0978	4	Sechskantmutter	Hexagon nut	M20 DIN934-8 Zn
5	305 6012	8	Scheibe	Washer	21 ISO7089 Zn
6	461 6060	2	Schienenplatte	Plate	20x199x212 1xD55,7
7	461 7924	1	Schienenwelle	Drawbar	D55x1110 L3 Z2
8	461 9892	2	Sperrstück	Stop	D55x100 2xD18
9	46110015	1	Schienenwelle	Drawbar	D55x1110 L3 Z2 HÜ

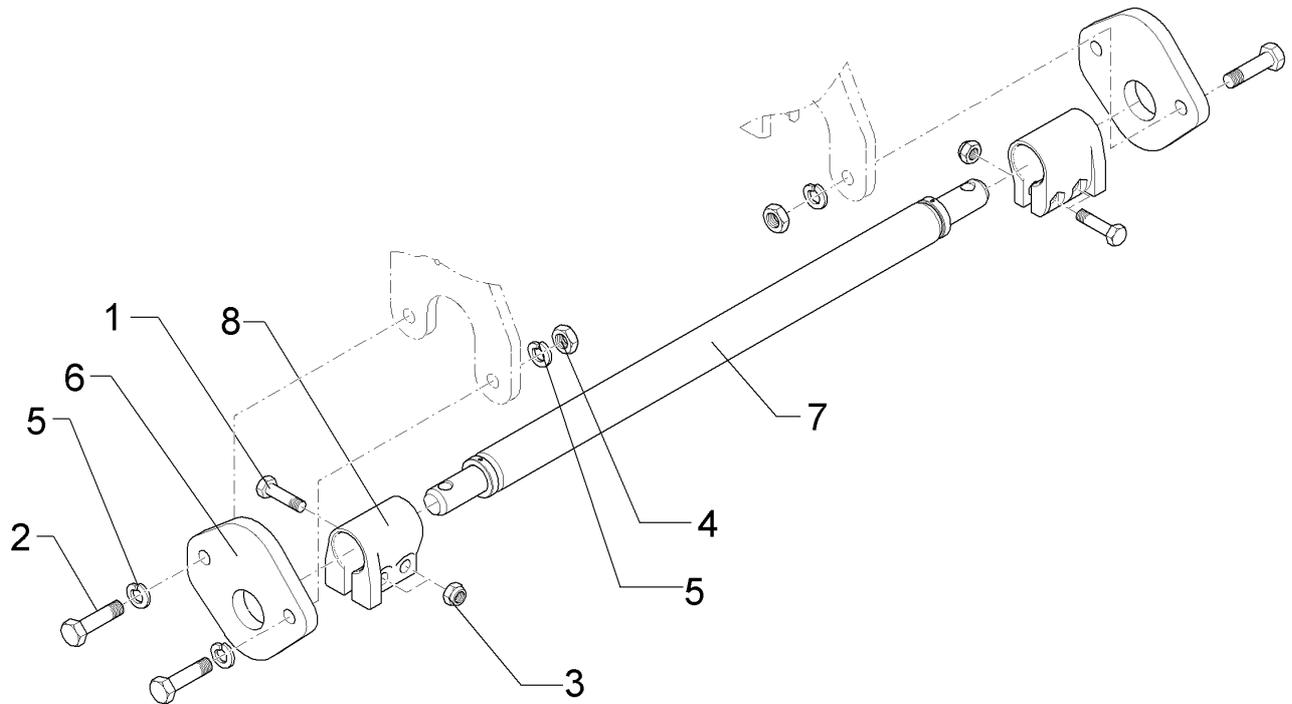

01.18

Pos.	Art.Nr.	Stck.	Artikeltext / Description		Abmessung
1	301 3868	4	Sechskantschraube	Hexagon bolt	M16x65-8.8 Zn DIN931-A
2	301 5390	4	Sechskantschraube spz.	Hexagon bolt	M20x65-12.9 Zn
3	303 0935	4	Sicherungsmutter	Selflocking nut	NM16-8 Zn DIN985
4	303 0978	4	Sechskantmutter	Hexagon nut	M20 DIN934-8 Zn
5	305 6012	8	Scheibe	Washer	21 ISO7089 Zn
6	461 6061	2	Schienenplatte	Plate	20x199x212 1xD68,7
7	461 7925	1	Zugschiene	Cross shaft	D68x1120 L3 Z3 HÜ
8	461 9893	2	Sperrstück	Stop	D68x100 2xD18

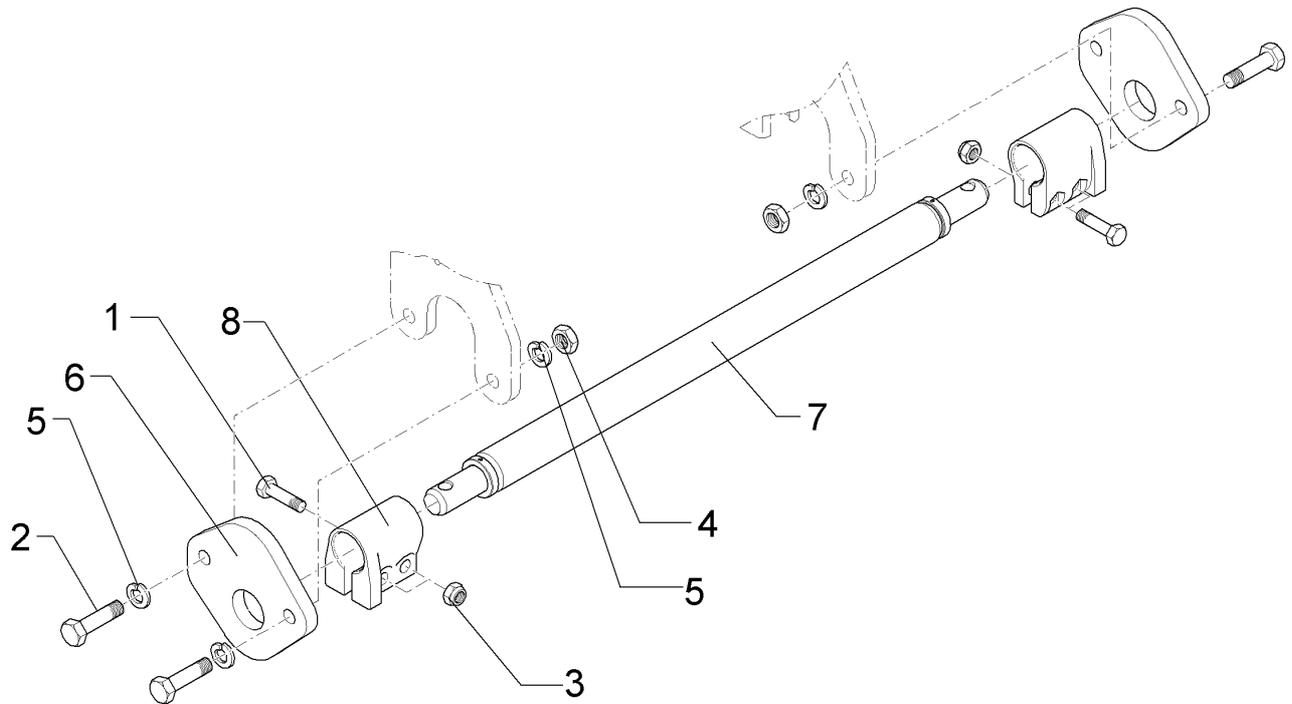

01.18

Pos.	Art.Nr.	Stck.	Artikeltext / Description		Abmessung
1	301 3868	4	Sechskantschraube	Hexagon bolt	M16x65-8.8 Zn DIN931-A
2	301 5390	4	Sechskantschraube spz.	Hexagon bolt	M20x65-12.9 Zn
3	303 0935	4	Sicherungsmutter	Selflocking nut	NM16-8 Zn DIN985
4	303 0978	4	Sechskantmutter	Hexagon nut	M20 DIN934-8 Zn
5	305 6012	8	Scheibe	Washer	21 ISO7089 Zn
6	461 6061	2	Schienenplatte	Plate	20x199x212 1xD68,7
7	461 7905	1	Zugschiene	Cross shaft	D68x980 L2 Z3 HÜ (Kat.3N)
8	461 9893	2	Sperrstück	Stop	D68x100 2xD18

Unterlenkeranschluss/Lower link connection	1
Juwel 7M	661 1443

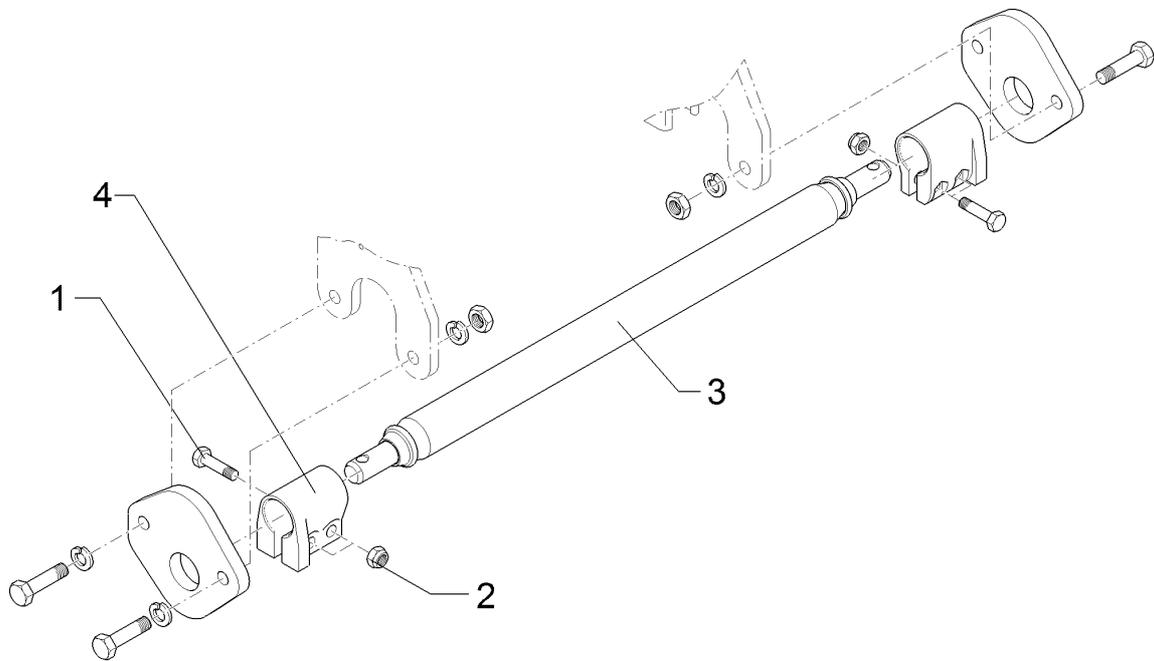

01.18

Pos.	Art.Nr.	Stck.	Artikeltext / Description		Abmessung
1	301 3868	4	Sechskantschraube	Hexagon bolt	M16x65-8.8 Zn DIN931-A
2	303 0935	4	Sicherungsmutter	Selflocking nut	NM16-8 Zn DIN985
3	461 7905	1	Zugschiene	Cross shaft	D68x980 L2 Z3 HÜ (Kat.3N)
4	461 9893	2	Sperrstück	Stop	D68x100 2xD18

Unterlenkeranschluss/Lower link connection	1
Juwel 7M	661 1444

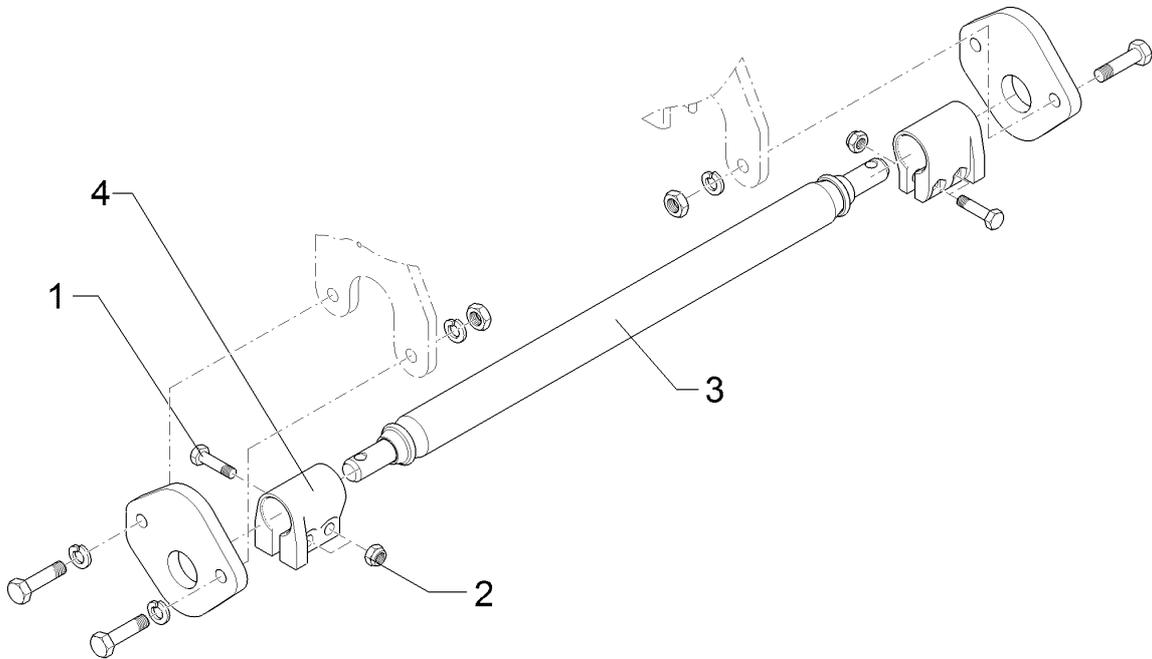

01.18

Pos.	Art.Nr.	Stck.	Artikeltext / Description		Abmessung
1	301 3868	4	Sechskantschraube	Hexagon bolt	M16x65-8.8 Zn DIN931-A
2	303 0935	4	Sicherungsmutter	Selflocking nut	NM16-8 Zn DIN985
3	461 7925	1	Zugschiene	Cross shaft	D68x1120 L3 Z3 HÜ
4	461 9893	2	Sperrstück	Stop	D68x100 2xD18

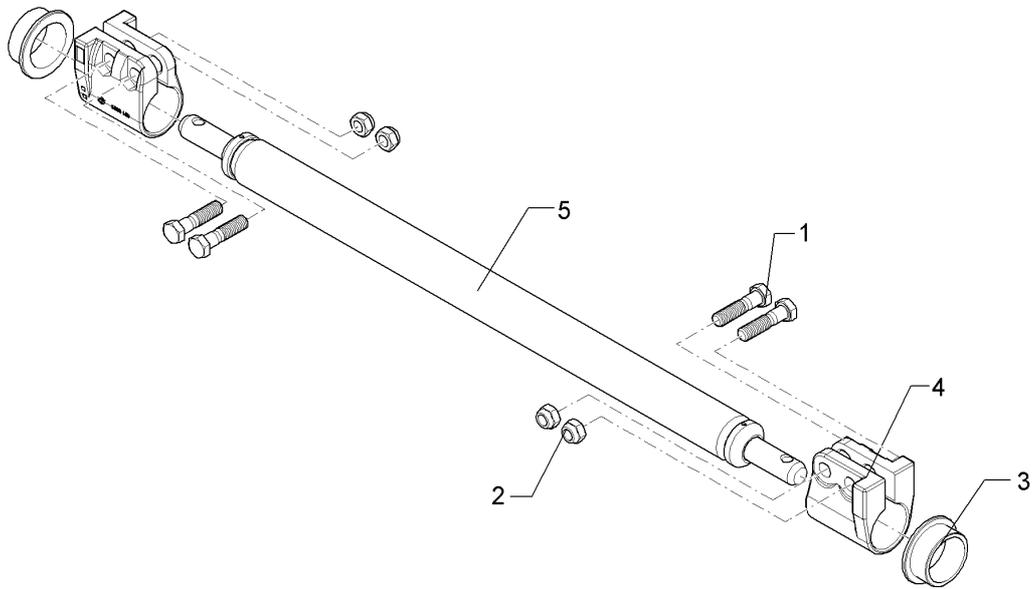

01.18

Pos.	Art.Nr.	Stck.	Artikeltext / Description		Abmessung
1	301 3868	4	Sechskantschraube	Hexagon bolt	M16x65-8.8 Zn DIN931-A
2	303 0935	4	Sicherungsmutter	Selflocking nut	NM16-8 Zn DIN985
3	317 9478	2	Bundbuchse	Flange bushing	56/67/82,5x30
4	461 9892	2	Sperrstück	Stop	D55x100 2xD18
5	46110013	1	Zugschiene	Cross shaft	D55x970 L2 Z2 HÜ

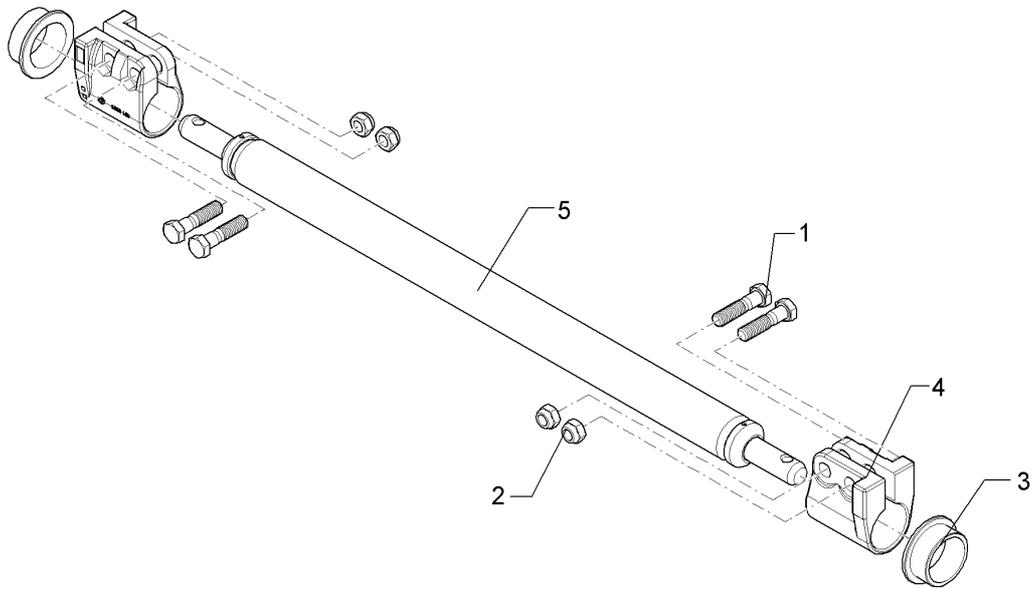

01.18

Pos.	Art.Nr.	Stck.	Artikeltext / Description		Abmessung
1	301 3868	4	Sechskantschraube	Hexagon bolt	M16x65-8.8 Zn DIN931-A
2	303 0935	4	Sicherungsmutter	Selflocking nut	NM16-8 Zn DIN985
3	317 9478	2	Bundbuchse	Flange bushing	56/67/82,5x30
4	461 9892	2	Sperrstück	Stop	D55x100 2xD18
5	46110015	1	Schienenwelle	Drawbar	D55x1110 L3 Z2 HÜ

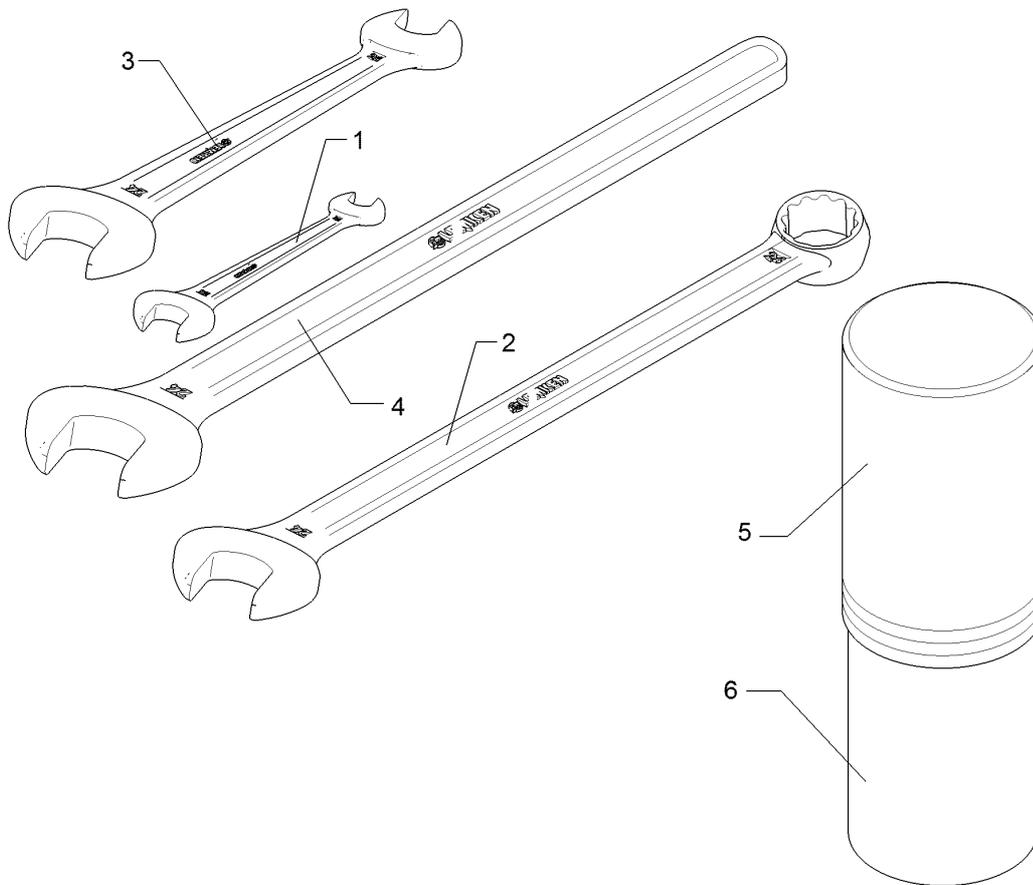

01.18

Pos.	Art.Nr.	Stck.	Artikeltext / Description	Abmessung	
1	321 9815	1	Schlüssel	Spanner	Gabel 19/22
2	321 9820	1	Schlüssel	Spanner	Gabel 24 Ring 30
3	321 9838	1	Schlüssel	Spanner	Gabel 30/24 DIN895 Zn
4	321 9855	1	Schlüssel	Spanner	Gabel 50 DIN894 Zn
5	886 4553	1	Gewindepack Oberteil	Winding bundle upper part	GP 90 055 A
6	886 4554	1	Gewindepack Unterteil	Winding bundle lower part	GP 90 245

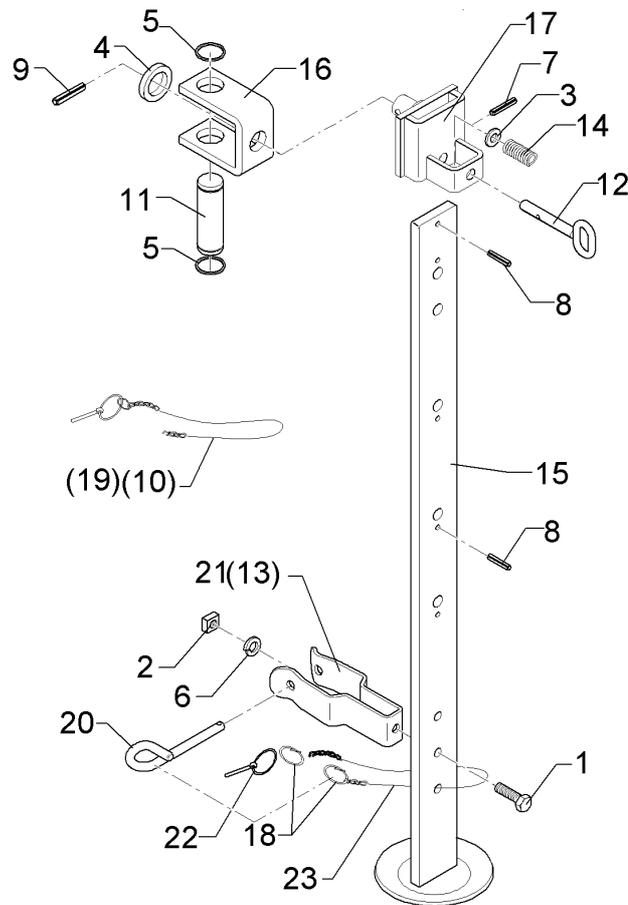

01.18

Pos.	Art.Nr.	Stck.	Artikeltext / Description		Abmessung
1	301 5004	1	Sechskantschraube	Hexagon bolt	M10x30-8.8 Zn DIN933
2	303 1100	1	Vierkantsmutter	Nut	M10 DIN557-5
3	305 8580	1	Scheibe	Washer	13/24x2,5 St-Zn DIN125
4	305 6254	1	Scheibe	Washer	D25/44x4 Zn ISO7089
5	305 8867	2	Sicherungsring	Retaining ring	30x2 DIN471 Zn
6	305 9900	1	Federring	Spring ring	10 DIN127 Zn
7	309 6038	1	Spannhülse	Expansion bush	5x30-DIN1481 Chrom 8
8	309 6052	2	Spannhülse	Expansion bush	6x32-DIN1481
9	309 6072	1	Spannhülse	Expansion bush	8x40-DIN1481 Zn
10	311 9320	1	Klappstift mit Kette	Securing pin	10x80
11	313 7803	1	Bolzen	Pin	D30x81,7/100 Zn
12	313 8136	1	Bolzen mit Griff	Pin with grip	D12x48,5/80 Zn
13	329 1798	1	Flachformfeder	U-spring	40x4x230 SW46
14	329 8106	1	Druckfeder	Compression spring	1,6x16x51,5
15	429 2511	1	Abstellstütze	Stand	V-R900 60x12x1000
16	429 4585	1	Halter	Holder	60/65/90 D30/D25
17	429 4600	1	Führung	Guiding	62/14x80 D25
18	305 8551	2	Sicherungsring	Retaining ring	Di41x3 A2
19	311 9566	1	Klappstift mit Kette	Securing pin	4,5 23GL
20	313 8610	1	Bolzen	Pin	D10x85 Zn (10x210)
21	329 1802	1	Flachformfeder	U-spring	40x4x370 SW60

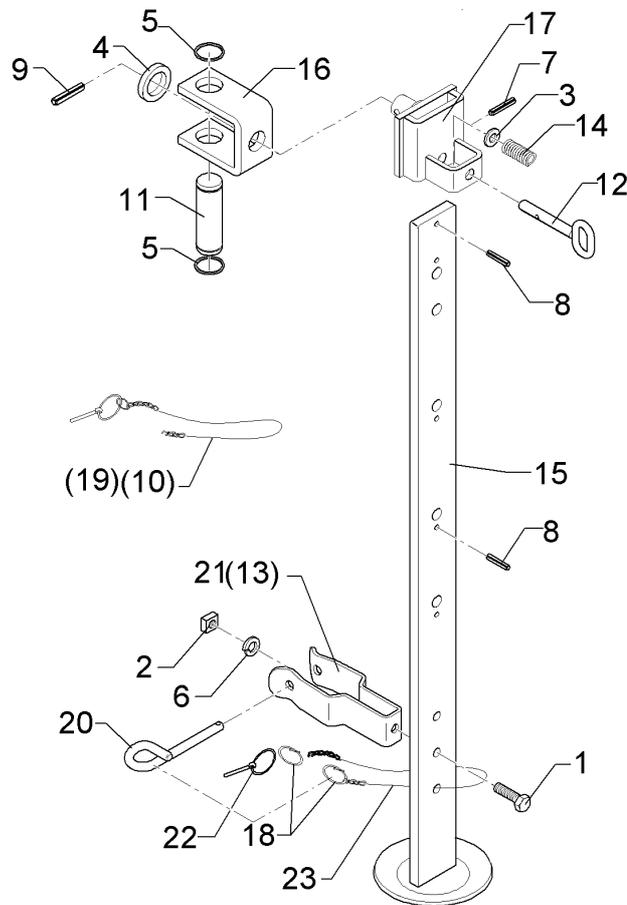

01.18

Pos.	Art.Nr.	Stck.	Artikeltext / Description	Abmessung
22	311 9565	1	Klappstift	Securing pin
23	33110043	1	Knotenkette	Knotted-link chain
				4,5 K22x580 Zn

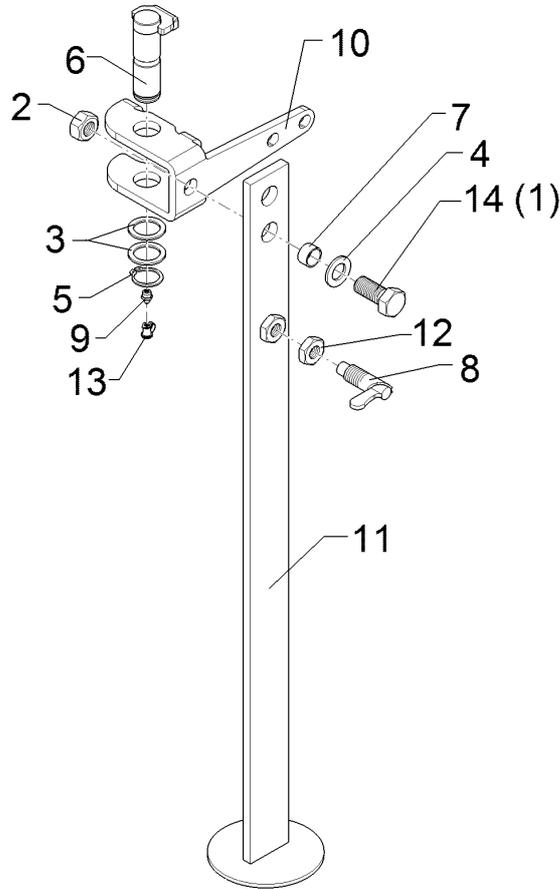

01.18

Pos.	Art.Nr.	Stck.	Artikeltext / Description		Abmessung
1	301 4213	1	Sechskantschraube	Hexagon bolt	M20x45-8.8 Zn DIN933
2	303 0936	1	Sicherungsmutter	Selflocking nut	NM20-8 Zn DIN985
3	305 2242	2	Stützscheibe	Supporting washer	S 30/42x2,5 DIN988 Zn
4	305 6012	1	Scheibe	Washer	21 ISO7089 Zn
5	305 8867	1	Sicherungsring	Retaining ring	30x2 DIN471 Zn
6	313 3008	1	Bolzen mit Verdrehsicherung	Pin with stop	D30x87/108 Zn
7	31710040	1	Röhrchen	Tube	D24/20,5x13 Zn
8	321 2601	1	Federriegel	Locking bar	D15 Hub14 Zn
9	323 6348	1	Schmiernippel	Grease nipple	AM10x1 DIN71412
10	42910012	1	Halter	Holder	10x295x331 2xD30,5 4xGEB Zn
11	42910013	1	Abstellstütze	Stand	R800-850 Juwel
12	303 0965	1	Sechskantmutter	Hexagon nut	M20x1,5 DIN936-17H Zn
13	323 6401	1	Schutzkappe	Cap	M6-M10
14	301 4231	1	Sechskantschraube	Hexagon bolt	M20x50-8.8 Zn DIN933

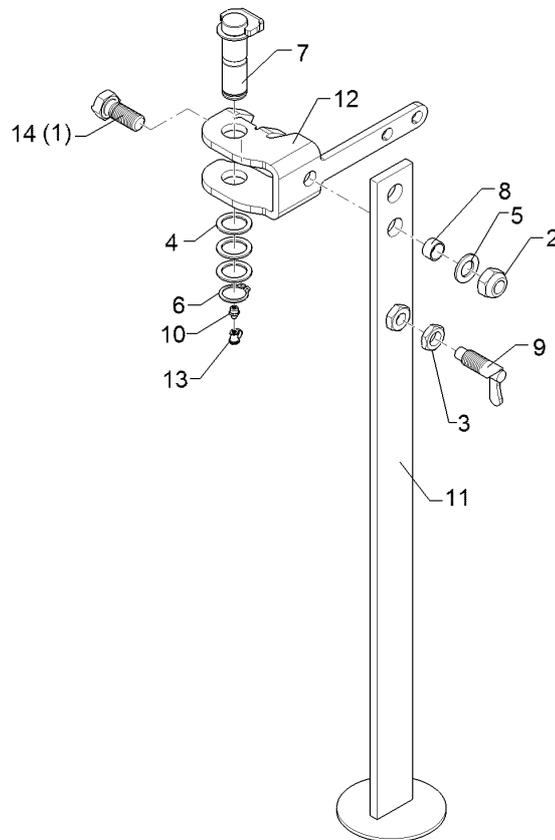

01.18

Pos.	Art.Nr.	Stck.	Artikeltext / Description		Abmessung
1	301 4213	1	Sechskantschraube	Hexagon bolt	M20x45-8.8 Zn DIN933
2	303 0936	1	Sicherungsmutter	Selflocking nut	NM20-8 Zn DIN985
3	303 0965	1	Sechskantmutter	Hexagon nut	M20x1,5 DIN936-17H Zn
4	305 2242	4	Stützscheibe	Supporting washer	S 30/42x2,5 DIN988 Zn
5	305 6012	1	Scheibe	Washer	21 ISO7089 Zn
6	305 8867	1	Sicherungsring	Retaining ring	30x2 DIN471 Zn
7	313 3008	1	Bolzen mit Verdrehsicherung	Pin with stop	D30x87/108 Zn
8	31710040	1	Röhrchen	Tube	D24/20,5x13 Zn
9	321 2601	1	Federriegel	Locking bar	D15 Hub14 Zn
10	323 6348	1	Schmiernippel	Grease nipple	AM10x1 DIN17142
11	42910013	1	Abstellstütze	Stand	R800-850 Juwel
12	42910031	1	Halter	Holder	10x295x329 J7M Zn
14	301 4231	1	Sechskantschraube	Hexagon bolt	M20x50-8.8 Zn DIN933

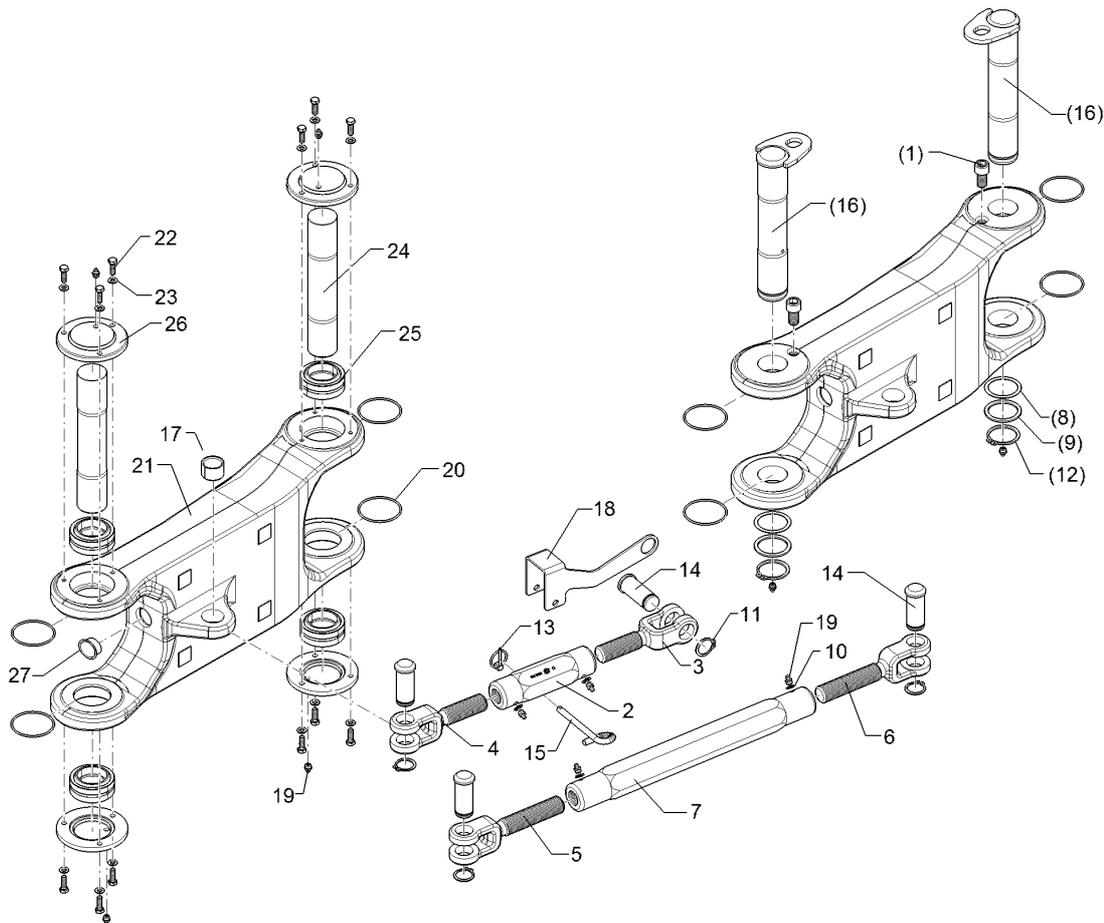

01.18

Pos.	Art.Nr.	Stck.	Artikeltext / Description		Abmessung
1	301 6004	2	Zylinderschraube	Allen screw	M16x30-8.8 DIN912
2	302 8785	1	Spannschlossmutter	Threaded sleeve	TR30x3x190-SW50
3	302 8998	1	Gabelstück	Forkpiece	TR30x3x80/185 D30 Zn
4	302 8999	1	Gabelstück	Forkpiece	TR30x3LHx80/185 D30 Zn
5	302 9000	1	Gabelstück	Forkpiece	TR30x3x120x225 D30 Zn
6	302 9001	1	Gabelstück	Forkpiece	TR30x3LHx120/225 D30 Zn
7	30210025	1	Spannschlossmutter	Threaded sleeve	TR30x3x490-SW50
8	305 2150	2	Passscheibe	Shim	50x62x1,0 DIN988
9	305 2255	2	Stützscheibe	Supporting washer	S 50x62x3 DIN988 Zn
10	305 6130	4	Scheibe	Washer	D10/16x1 Zn
11	305 8867	3	Sicherungsring	Retaining ring	30x2 DIN471 Zn
12	305 8877	2	Sicherungsring	Retaining ring	50x3 DIN471
13	311 9565	1	Klappstift	Securing pin	4,5
14	313 7802	3	Bolzen mit Kopf	Pin with collar	D30/35x63/80 Zn
15	313 8610	1	Bolzen	Pin	D10x85 Zn (10x210)
16	31310043	2	Bolzen mit Verdrehsicherung	Pin with stop	D50x265/290-M10x1 Zn
17	317 3417	1	Einspannbuchse mit Presssitz	Expansion bush	EG30/38x25
18	32110019	1	Verdrehsicherung	Locking	4x231x208,1 D30 U-51 Zn
19	323 6348	8	Schmiernippel	Grease nipple	AM10x1 DIN71412

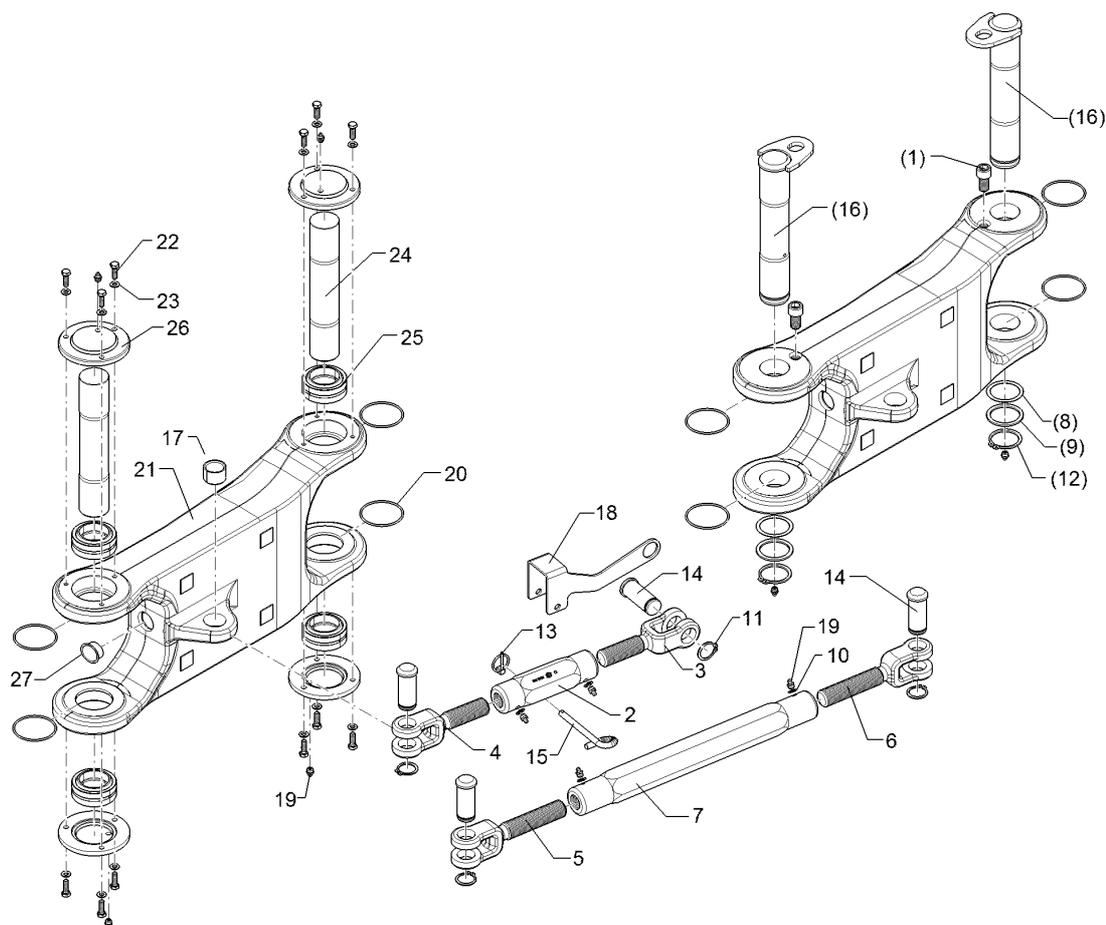

01.18

Pos.	Art.Nr.	Stck.	Artikeltext / Description	Abmessung
20	375 1255	4	O-Ring	O-ring 68x3-80Shore Viton83
21	43410001	1	Lenker	Link 75-600 J7 GEB
22	301 7280	12	Sechskantschraube	Hexagon bolt M8x25-8.8 Zn DIN933
23	305 8694	12	Scheibe	Washer A8,4 DIN125-St Zn
24	31310061	2	Bolzen	Pin D50/48x275 1xM8
25	31710056	4	Gelenklager	Articulated bearing GE 50 ES
26	32310053	4	Deckel	Cover D120x15 3xD8,5-98 Zn
27	32310031	3	Lamellenstopfen	Lamellar cap GPN 320 GL 40 RAL5015

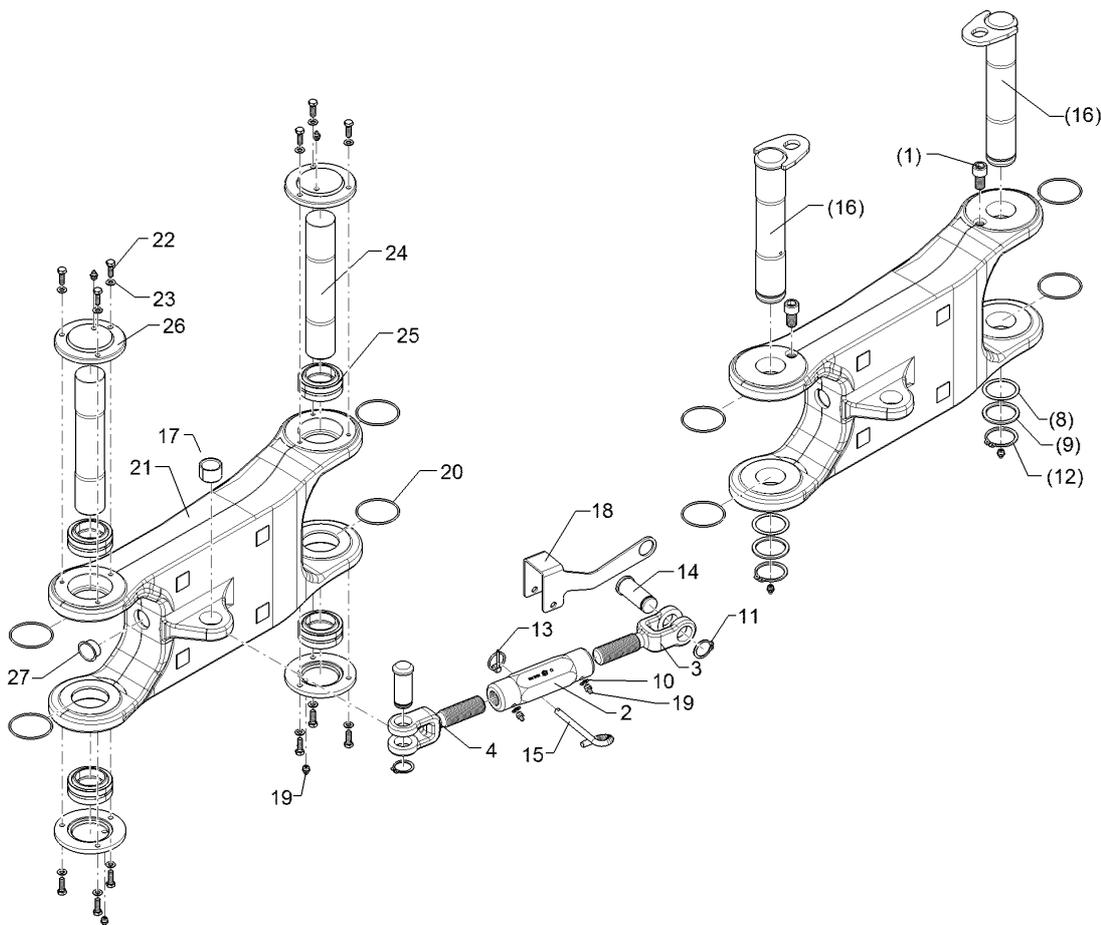

01.18

Pos.	Art.Nr.	Stck.	Artikeltext / Description		Abmessung
1	301 6004	2	Zylinderschraube	Allen screw	M16x30-8.8 DIN912
2	302 8785	1	Spannschlossmutter	Threaded sleeve	TR30x3x190-SW50
3	302 8998	1	Gabelstück	Forkpiece	TR30x3x80/185 D30 Zn
4	302 8999	1	Gabelstück	Forkpiece	TR30x3LHx80/185 D30 Zn
8	305 2150	2	Passscheibe	Shim	50x62x1,0 DIN988
9	305 2255	2	Stützscheibe	Supporting washer	S 50x62x3 DIN988 Zn
10	305 6130	2	Scheibe	Washer	D10/16x1 Zn
11	305 8867	2	Sicherungsring	Retaining ring	30x2 DIN471 Zn
12	305 8877	2	Sicherungsring	Retaining ring	50x3 DIN471
13	311 9565	1	Klappstift	Securing pin	4,5
14	313 7802	2	Bolzen mit Kopf	Pin with collar	D30/35x63/80 Zn
15	313 8610	1	Bolzen	Pin	D10x85 Zn (10x210)
16	31310043	2	Bolzen mit Verdrehsicherung	Pin with stop	D50x265/290-M10x1 Zn
17	317 3417	1	Einspannbuchse mit Presssitz	Expansion bush	EG30/38x25
18	32110019	1	Verdrehsicherung	Locking	4x231x208,1 D30 U-51 Zn
19	323 6348	6	Schmiernippel	Grease nipple	AM10x1 DIN71412
20	375 1255	4	O-Ring	O-ring	68x3-80Shore Viton83
21	43410001	1	Lenker	Link	75-600 J7 GEB
22	301 7280	12	Sechskantschraube	Hexagon bolt	M8x25-8.8 Zn DIN933

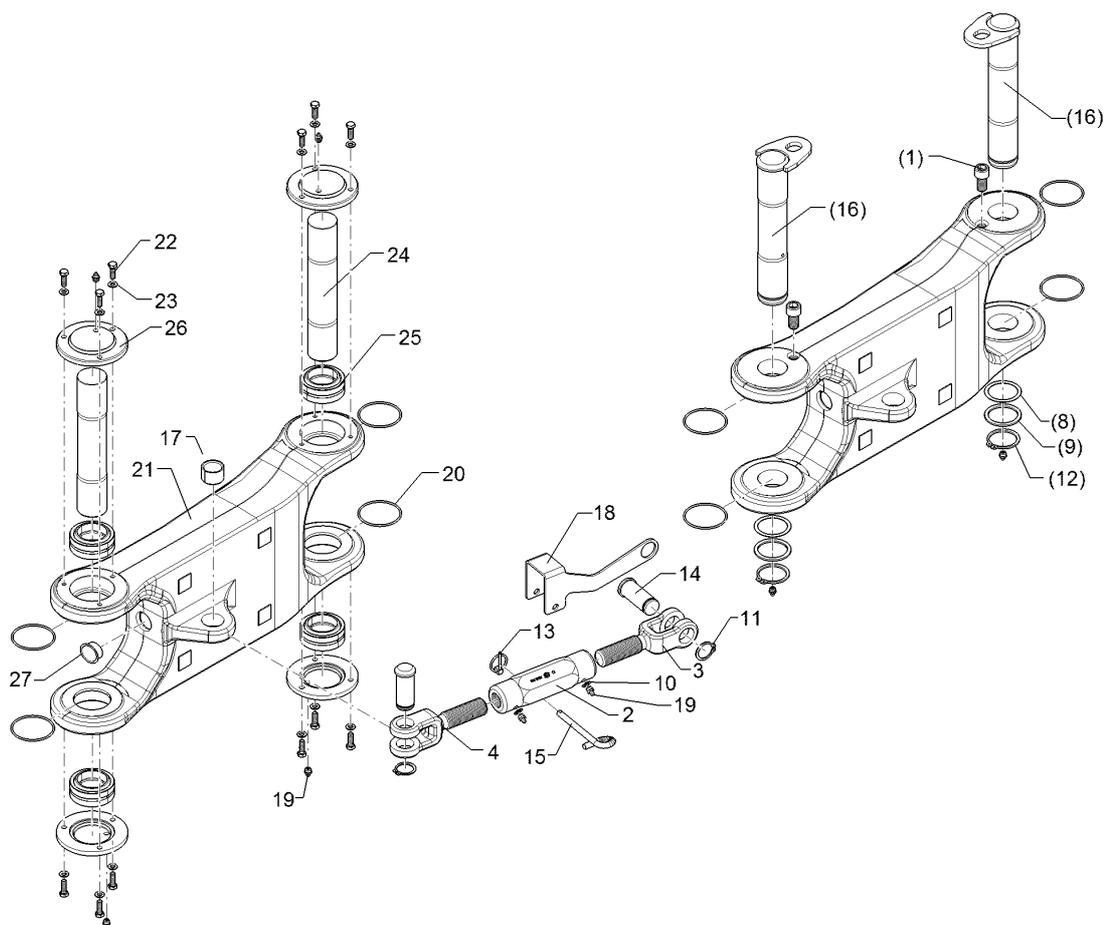

01.18

Pos.	Art.Nr.	Stck.	Artikeltext / Description	Abmessung	
23	305 8694	12	Scheibe	Washer	A8,4 DIN125-St Zn
24	31310061	2	Bolzen	Pin	D50/48x275 1xM8
25	31710056	4	Gelenklager	Articulated bearing	GE 50 ES
26	32310053	4	Deckel	Cover	D120x15 3xD8,5-98 Zn
27	32310031	3	Lamellenstopfen	Lamellar cap	GPN 320 GL 40 RAL5015

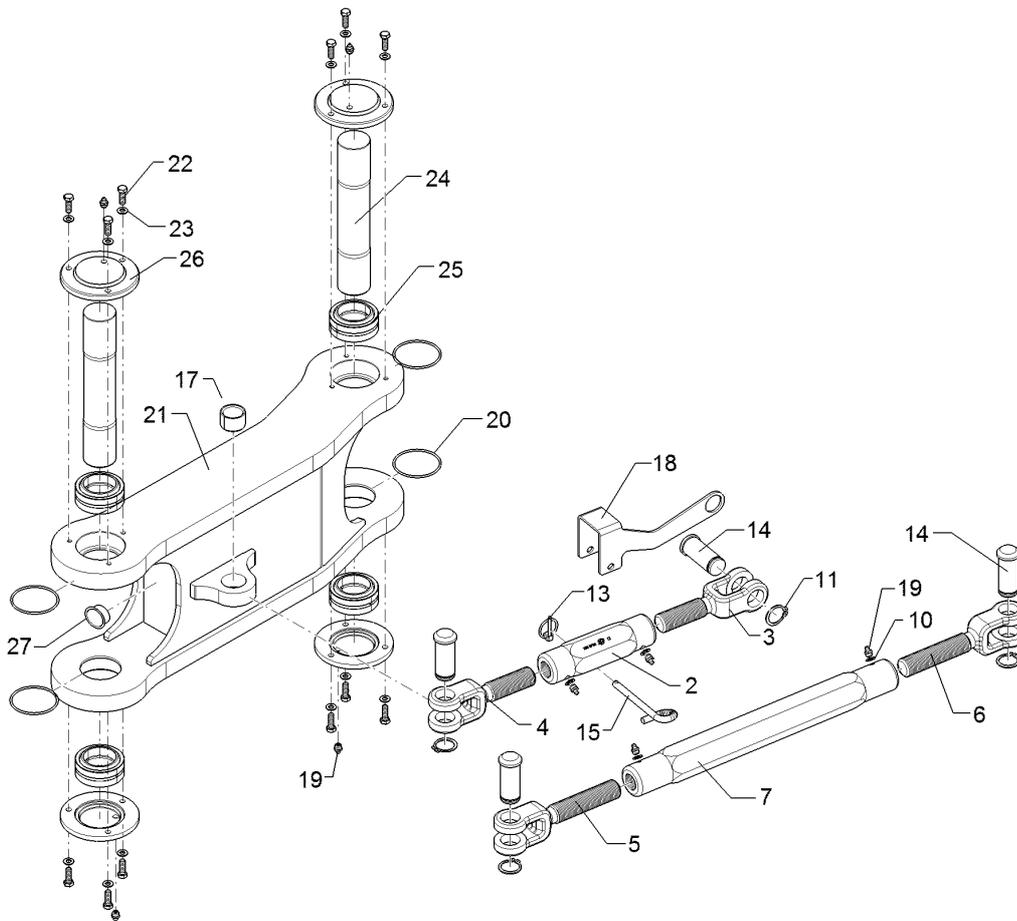

01.18

Pos.	Art.Nr.	Stck.	Artikeltext / Description	Abmessung
25	31710056	4	Gelenklager	Articulated bearing
26	32310053	4	Deckel	Cover
				GE 50 ES D120x15 3xD8,5-98 Zn

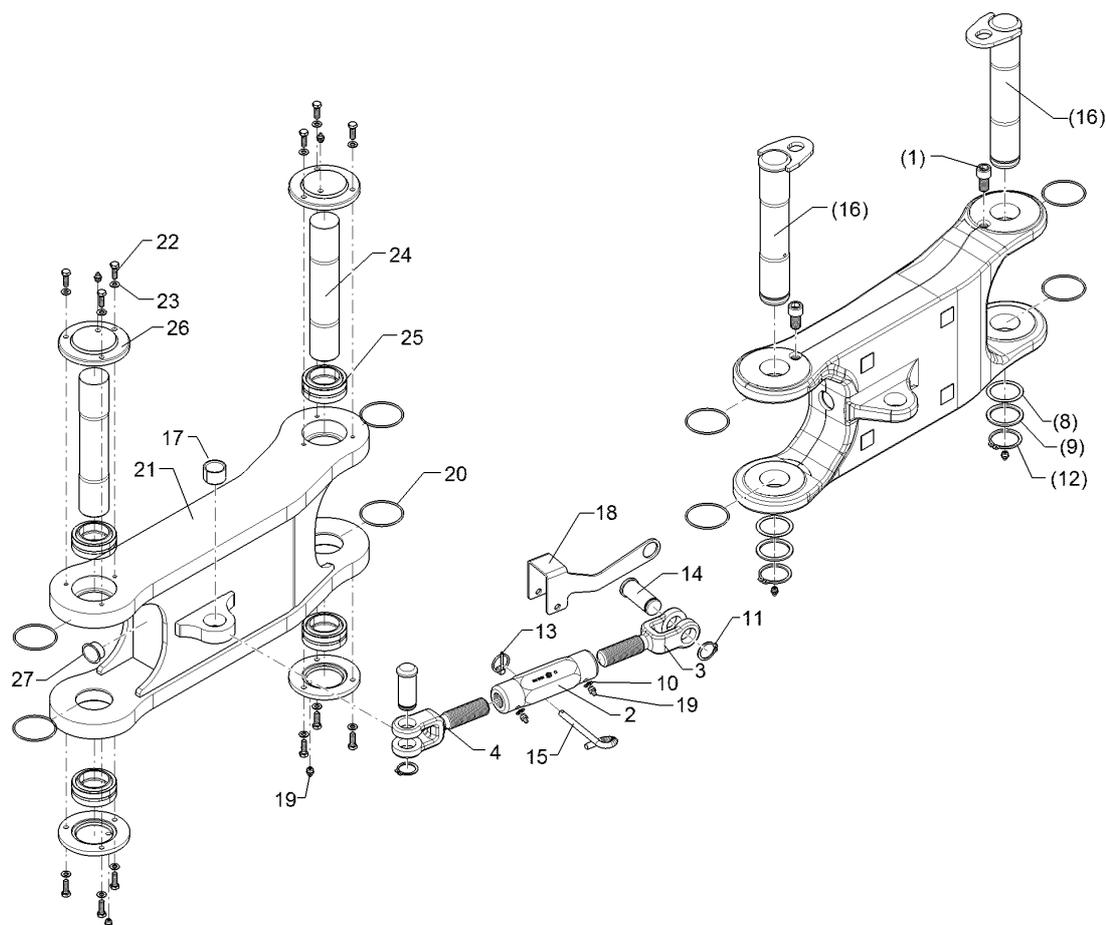

01.18

Pos.	Art.Nr.	Stck.	Artikeltext / Description		Abmessung
2	302 8785	1	Spannschlossmutter	Threaded sleeve	TR30x3x190-SW50
3	302 8998	1	Gabelstück	Forkpiece	TR30x3x80/185 D30 Zn
4	302 8999	1	Gabelstück	Forkpiece	TR30x3LHx80/185 D30 Zn
10	305 6130	2	Scheibe	Washer	D10/16x1 Zn
11	305 8867	2	Sicherungsring	Retaining ring	30x2 DIN471 Zn
13	311 9565	1	Klappstift	Securing pin	4,5
14	313 7802	2	Bolzen mit Kopf	Pin with collar	D30/35x63/80 Zn
15	313 8610	1	Bolzen	Pin	D10x85 Zn (10x210)
17	317 3417	1	Einspannbuchse mit Presssitz	Expansion bush	EG30/38x25
18	32110019	1	Verdrehsicherung	Locking	4x231x208,1 D30 U-51 Zn
19	323 6348	6	Schmiernippel	Grease nipple	AM10x1 DIN71412
20	375 1255	4	O-Ring	O-ring	68x3-80Shore Viton83
21	43410005	1	Lenker	Link	75-600 Juwel 7
22	301 7280	12	Sechskantschraube	Hexagon bolt	M8x25-8.8 Zn DIN933
23	305 8694	12	Scheibe	Washer	A8,4 DIN125-St Zn
24	31310061	2	Bolzen	Pin	D50/48x275 1xM8
25	31710056	4	Gelenklager	Articulated bearing	GE 50 ES
26	32310053	4	Deckel	Cover	D120x15 3xD8,5-98 Zn

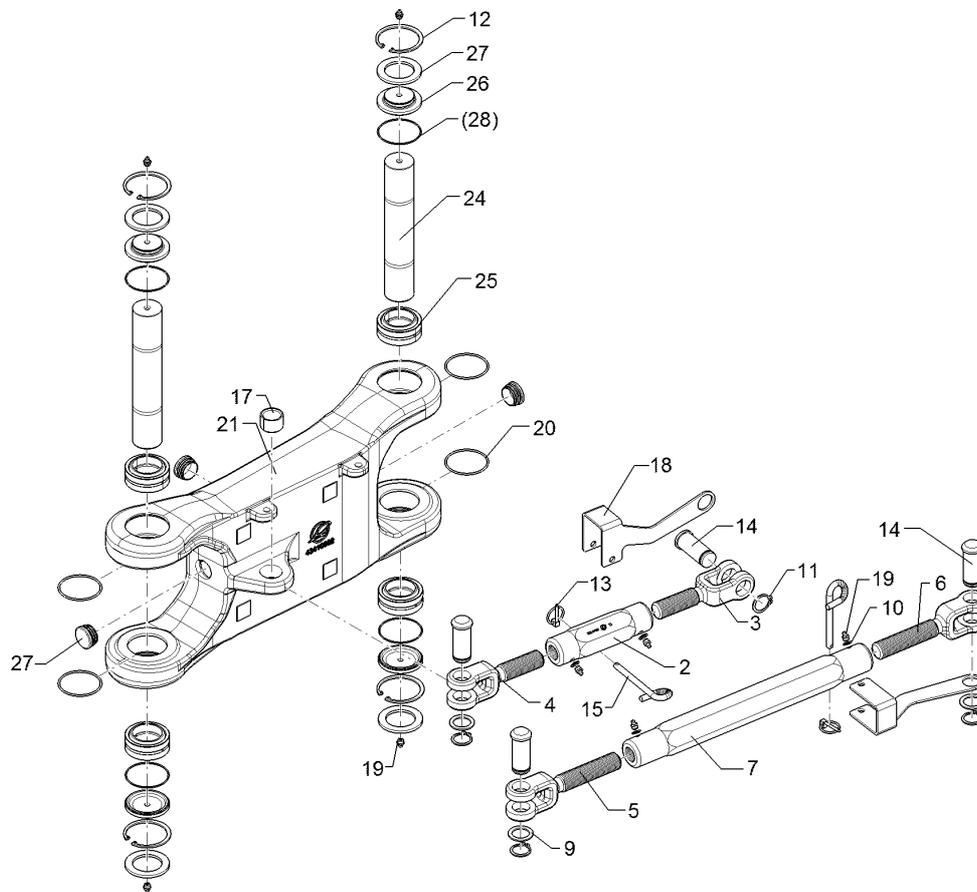

01.18

Pos.	Art.Nr.	Stck.	Artikeltext / Description	Abmessung	
2	302 8785	1	Spannschlossmutter	Threaded sleeve	TR30x3x190-SW50
3	302 8998	1	Gabelstück	Forkpiece	TR30x3x80/185 D30 Zn
4	302 8999	1	Gabelstück	Forkpiece	TR30x3LHx80/185 D30 Zn
5	302 9000	1	Gabelstück	Forkpiece	TR30x3x120x225 D30 Zn
6	302 9001	1	Gabelstück	Forkpiece	TR30x3LHx120/225 D30 Zn
7	30210025	1	Spannschlossmutter	Threaded sleeve	TR30x3x490-SW50
9	305 2242	1	Stützscheibe	Supporting washer	S 30/42x2,5 DIN988 Zn
10	305 6130	4	Scheibe	Washer	D10/16x1 Zn
11	305 8867	3	Sicherungsring	Retaining ring	30x2 DIN471 Zn
12	30510166	4	Sicherungsring	Retaining ring	75x3/JS75 DIN472
13	311 9565	2	Klappstift	Securing pin	4,5
14	313 7802	3	Bolzen mit Kopf	Pin with collar	D30/35x63/80 Zn
15	313 8610	2	Bolzen	Pin	D10x85 Zn (10x210)
16	31310061	2	Bolzen	Pin	D50/48x275 1xM8
17	317 3417	1	Einspannbuchse mit Presssitz	Expansion bush	EG30/38x25
18	32110019	2	Verdrehsicherung	Locking	4x231x208,1 D30 U-51 Zn
19	323 6348	8	Schmiernippel	Grease nipple	AM10x1 DIN71412
20	375 1255	4	O-Ring	O-ring	68x3-80Shore Viton83
21	43410002	1	Lenker	Link	75/50-600 RGL J7

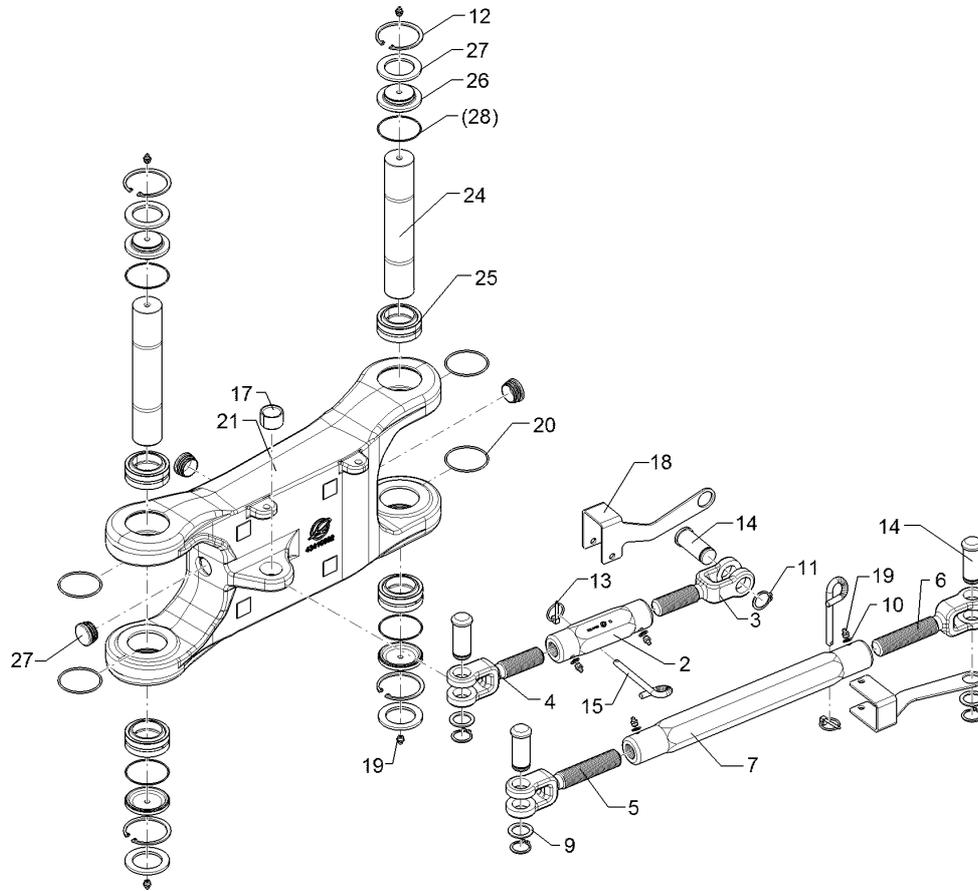

01.18

Pos.	Art.Nr.	Stck.	Artikeltext / Description	Abmessung
25	31710056	4	Gelenklager	Articulated bearing
26	32310151	4	Deckel	Cover
27	32310152	4	Scheibe	Washer
28	375 1258	4	O-Ring	O-ring
				GE 50 ES
				D75x17,5 1xM10x1,5
				D75/50x5
				70x2

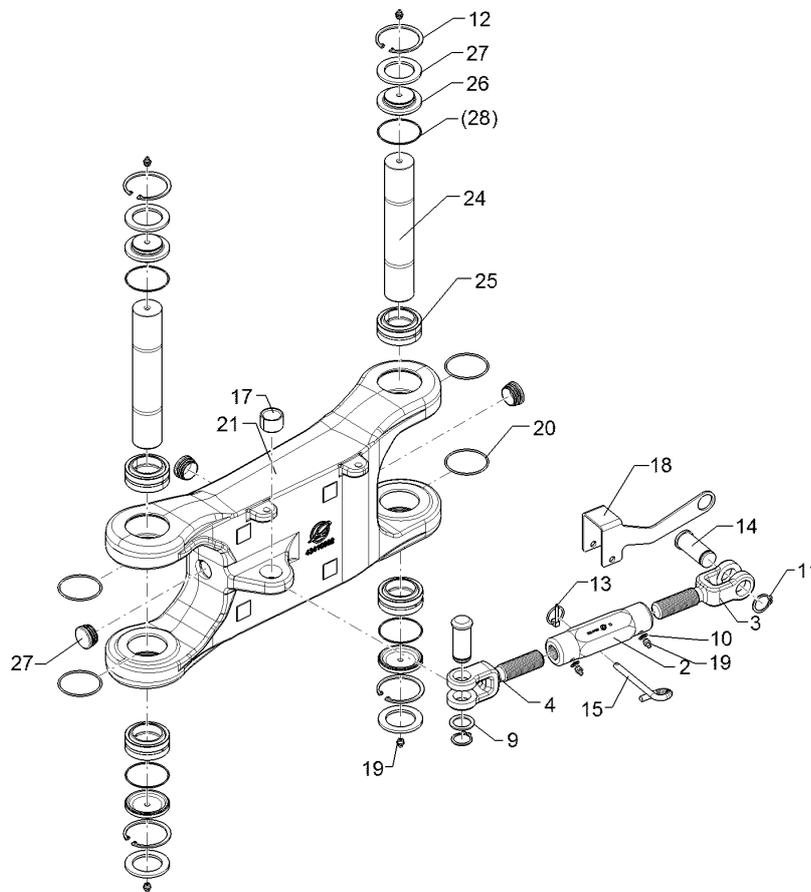

01.18

Pos.	Art.Nr.	Stck.	Artikeltext / Description		Abmessung
2	302 8785	1	Spannschlossmutter	Threaded sleeve	TR30x3x190-SW50
3	302 8998	1	Gabelstück	Forkpiece	TR30x3x80/185 D30 Zn
4	302 8999	1	Gabelstück	Forkpiece	TR30x3LHx80/185 D30 Zn
9	305 2242	1	Stützscheibe	Supporting washer	S 30/42x2,5 DIN988 Zn
10	305 6130	2	Scheibe	Washer	D10/16x1 Zn
11	305 8867	2	Sicherungsring	Retaining ring	30x2 DIN471 Zn
12	30510166	4	Sicherungsring	Retaining ring	75x3/JS75 DIN472
13	311 9565	1	Klappstift	Securing pin	4,5
14	313 7802	2	Bolzen mit Kopf	Pin with collar	D30/35x63/80 Zn
15	313 8610	1	Bolzen	Pin	D10x85 Zn (10x210)
17	317 3417	1	Einspannbuchse mit Presssitz	Expansion bush	EG30/38x25
18	32110019	1	Verdrehsicherung	Locking	4x231x208,1 D30 U-51 Zn
19	323 6348	6	Schmiernippel	Grease nipple	AM10x1 DIN71412
20	375 1255	4	O-Ring	O-ring	68x3-80Shore Viton83
21	43410002	1	Lenker	Link	75/50-600 RGL J7
24	31310061	2	Bolzen	Pin	D50/48x275 1xM8
25	31710056	4	Gelenklager	Articulated bearing	GE 50 ES
26	32310151	4	Deckel	Cover	D75x17,5 1xM10x1,5
27	32310152	4	Scheibe	Washer	D75/50x5
28	375 1258	4	O-Ring	O-ring	70x2

Anbauteil/Frame extension	3
---------------------------	----------

Juwel 7M	60210030
-----------------	-----------------

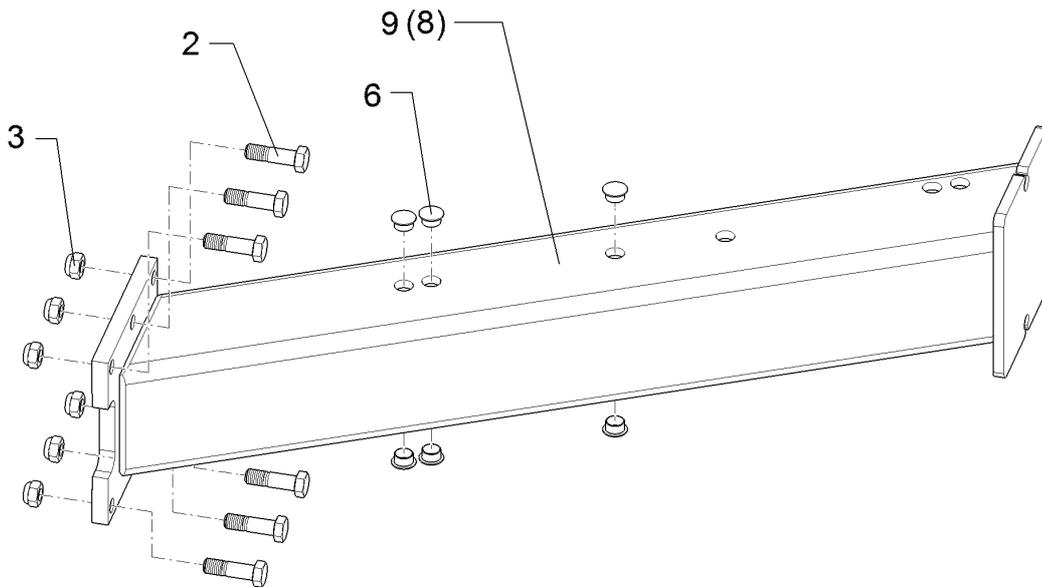

01.18

Pos.	Art.Nr.	Stck.	Artikeltext / Description		Abmessung
2	301 5385	6	Sechskantschraube spz.	Hexagon bolt	M16x55-10.9 Zn
3	303 0935	6	Sicherungsmutter	Selflocking nut	NM16-8 Zn DIN985
6	323 8053	6	Schutzkappe	Cap	GPN 300 F 19 RAL5015
8	402 8245	1	Anbauteil	Frame extension	EurOpal 7 90
9	40210073	1	Anbauteil	Frame extension	Juwel 7-90

Anbauteil/Frame extension	3
----------------------------------	----------

Juwel 7M	60210031
-----------------	-----------------

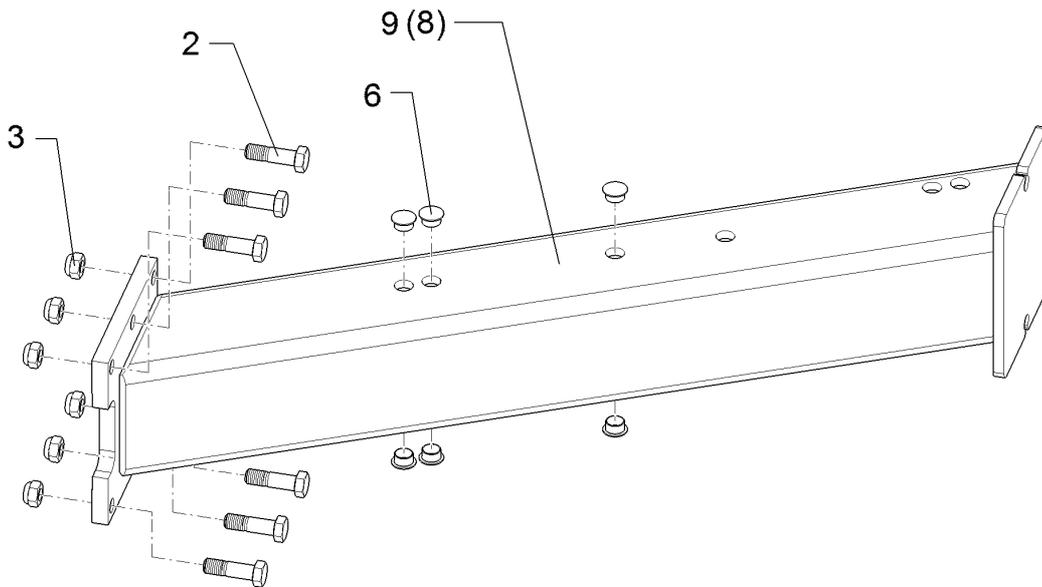

01.18

Pos.	Art.Nr.	Stck.	Artikeltext / Description		Abmessung
2	301 5385	6	Sechskantschraube spz.	Hexagon bolt	M16x55-10.9 Zn
3	303 0935	6	Sicherungsmutter	Selflocking nut	NM16-8 Zn DIN985
6	323 8053	12	Schutzkappe	Cap	GPN 300 F 19 RAL5015
8	402 8242	1	Anbauteil	Frame extension	EurOpal 7 100
9	40210074	1	Anbauteil	Frame extension	Juwel 7 120-100

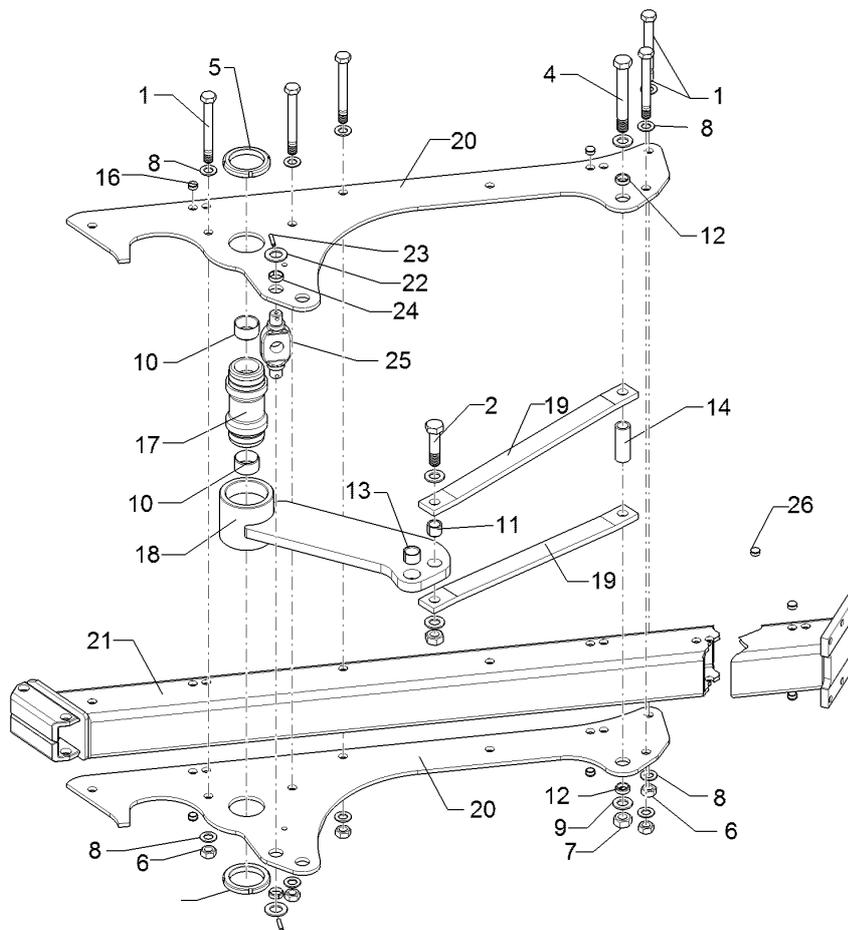

01.18

Pos.	Art.Nr.	Stck.	Artikeltext / Description		Abmessung
1	301 4523	5	Sechskantschraube spezial	Hexagon bolt	M20x1,5x170ls144xb23-10.9 Zn
2	301 4646	1	Sechskantschraube spz.	Hexagon bolt	M24x95-8.8 Zn
4	301 4802	1	Sechskantschraube spz.	Hexagon bolt	M24x180-10.9 Zn
5	303 0341	2	Nutmutter	Grooved nut	M80x2 KM16 Zn
6	303 0977	5	Sechskantmutter	Hexagon nut	M20x1,5 DIN934-10 Zn
7	303 1019	2	Sechskantmutter	Hexagon nut	M24 DIN934-8 Zn
8	305 6012	10	Scheibe	Washer	21 ISO7089 Zn
9	305 6254	4	Scheibe	Washer	D25/44x4 Zn ISO7089
10	317 2025	2	Einspannbuchse mit Presssitz	Expansion bush	EG50/55x30
11	317 3404	1	Einspannbuchse mit Presssitz	Expansion bush	EG24/32x25
12	317 3406	2	Einspannbuchse mit Presssitz	Expansion bush	EG24/32x10
13	317 3417	1	Einspannbuchse mit Presssitz	Expansion bush	EG30/38x25
14	317 6655	1	Röhrchen	Tube	33,7x4,5x90 Zn
16	323 8071	8	Schutzkappe	Cap	GPN 300V19 - D20 RAL5015
17	402 1282	1	Lagerrohr	Bearing tube	D50/M80/93x119x199,5 Zn
18	40210041	1	Schwinge	Rocker arm	D93,5x118 J7M
19	40210035	2	Strebe	Strut	50x15x618 2xD24,1 Juwel 7 090
20	40210039	2	Lagerplatte	Bearing plate	J7M-90
21	40210010	1	Grundrahmen	Basic frame	10x454x1355 Juwel 7(T) 3-90

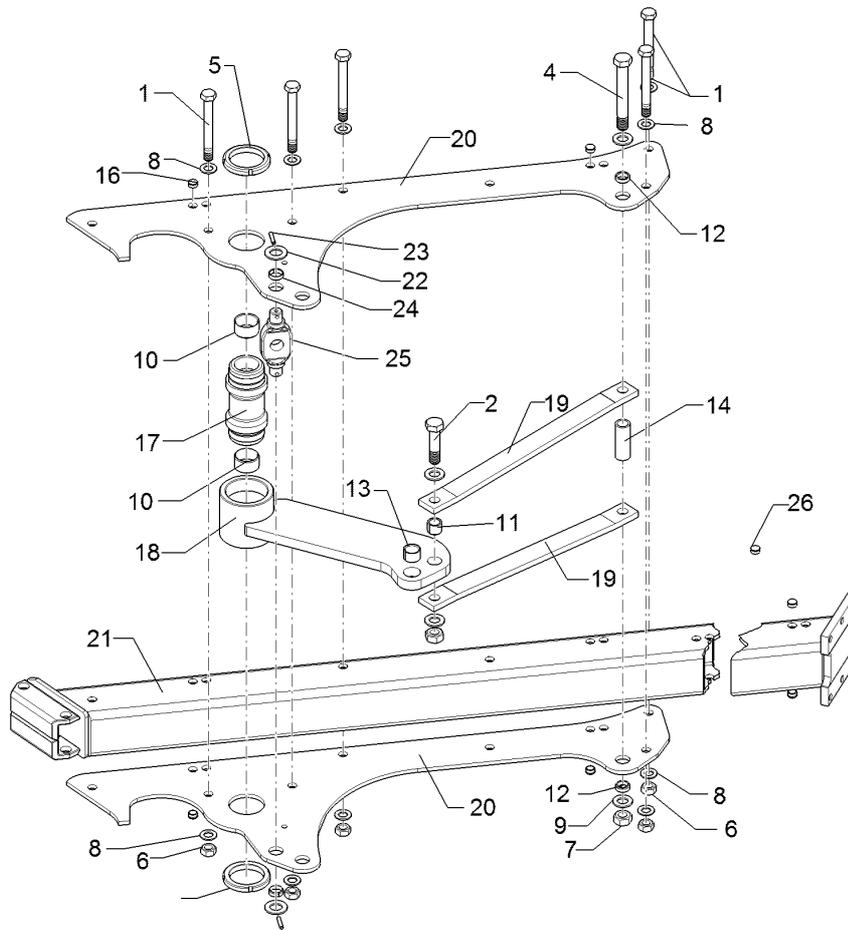

01.18

Pos.	Art.Nr.	Stck.	Artikeltext / Description	Abmessung	
22	305 6283	2	Scheibe	Washer	B28 DIN125
23	309 6072	2	Spannhülse	Expansion bush	8x40-DIN1481 Zn
24	317 3347	2	Einspannbuchse mit Presssitz	Expansion bush	EG28/32x10
25	402 1709	1	Kreuzgelenk	Cross union	VO7 70x38x173 D30 Z28 Zn

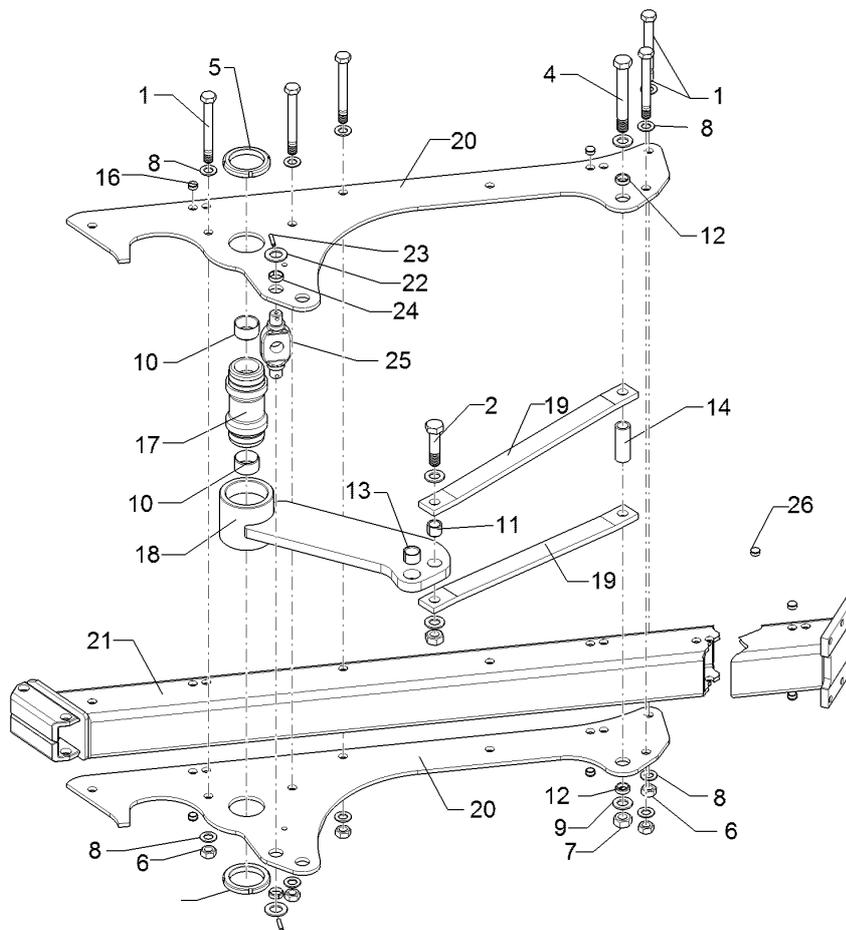

01.18

Pos.	Art.Nr.	Stck.	Artikeltext / Description		Abmessung
1	301 4523	5	Sechskantschraube spezial	Hexagon bolt	M20x1,5x170ls144xb23-10.9 Zn
2	301 4646	1	Sechskantschraube spz.	Hexagon bolt	M24x95-8.8 Zn
4	301 4802	1	Sechskantschraube spz.	Hexagon bolt	M24x180-10.9 Zn
5	303 0341	2	Nutmutter	Grooved nut	M80x2 KM16 Zn
6	303 0977	5	Sechskantmutter	Hexagon nut	M20x1,5 DIN934-10 Zn
7	303 1019	2	Sechskantmutter	Hexagon nut	M24 DIN934-8 Zn
8	305 6012	10	Scheibe	Washer	21 ISO7089 Zn
9	305 6254	4	Scheibe	Washer	D25/44x4 Zn ISO7089
10	317 2025	2	Einspannbuchse mit Presssitz	Expansion bush	EG50/55x30
11	317 3404	1	Einspannbuchse mit Presssitz	Expansion bush	EG24/32x25
12	317 3406	2	Einspannbuchse mit Presssitz	Expansion bush	EG24/32x10
13	317 3417	1	Einspannbuchse mit Presssitz	Expansion bush	EG30/38x25
14	317 6655	1	Röhrchen	Tube	33,7x4,5x90 Zn
16	323 8071	10	Schutzkappe	Cap	GPN 300V19 - D20 RAL5015
17	402 1282	1	Lagerrohr	Bearing tube	D50/M80/93x119x199,5 Zn
18	40210041	1	Schwinge	Rocker arm	D93,5x118 J7M
19	40210035	2	Strebe	Strut	50x15x618 2xD24,1 Juwel 7 090
20	40210039	2	Lagerplatte	Bearing plate	J7M-90
21	40210011	1	Grundrahmen	Basic frame	10x454x1355 Juwel 7(T) 4-90

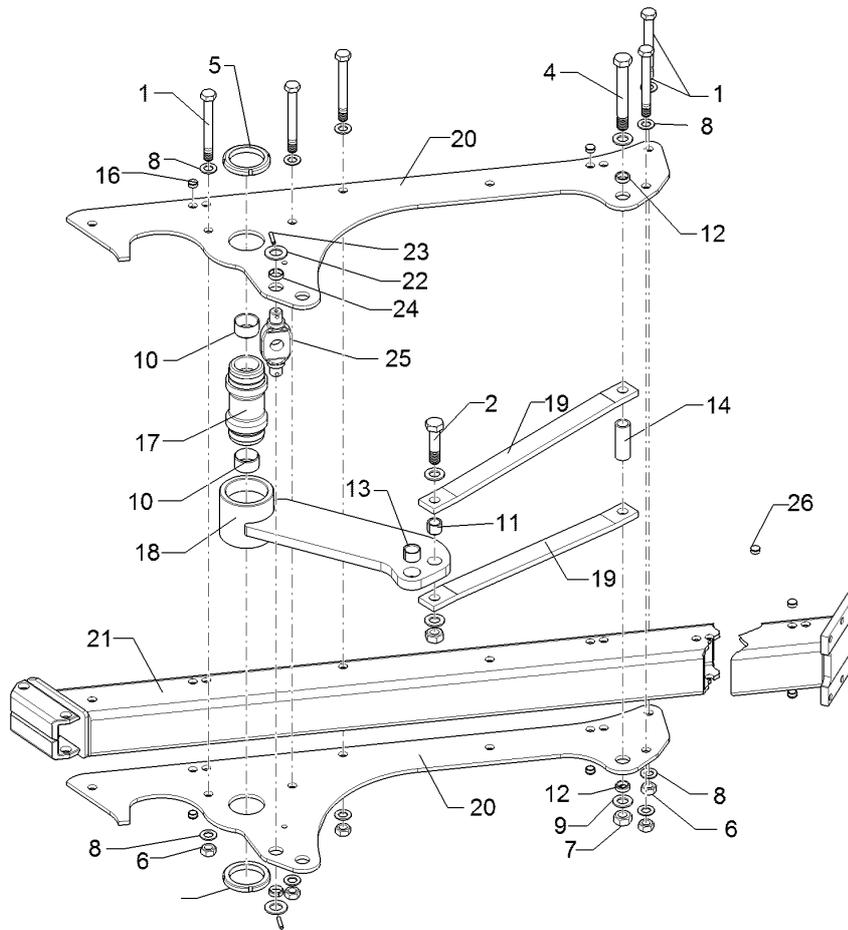

01.18

Pos.	Art.Nr.	Stck.	Artikeltext / Description	Abmessung	
22	305 6283	2	Scheibe	Washer	B28 DIN125
23	309 6072	2	Spannhülse	Expansion bush	8x40-DIN1481 Zn
24	317 3347	2	Einspannbuchse mit Presssitz	Expansion bush	EG28/32x10
25	402 1709	1	Kreuzgelenk	Cross union	VO7 70x38x173 D30 Z28 Zn
26	323 8053	6	Schutzkappe	Cap	GPN 300 F 19 RAL5015

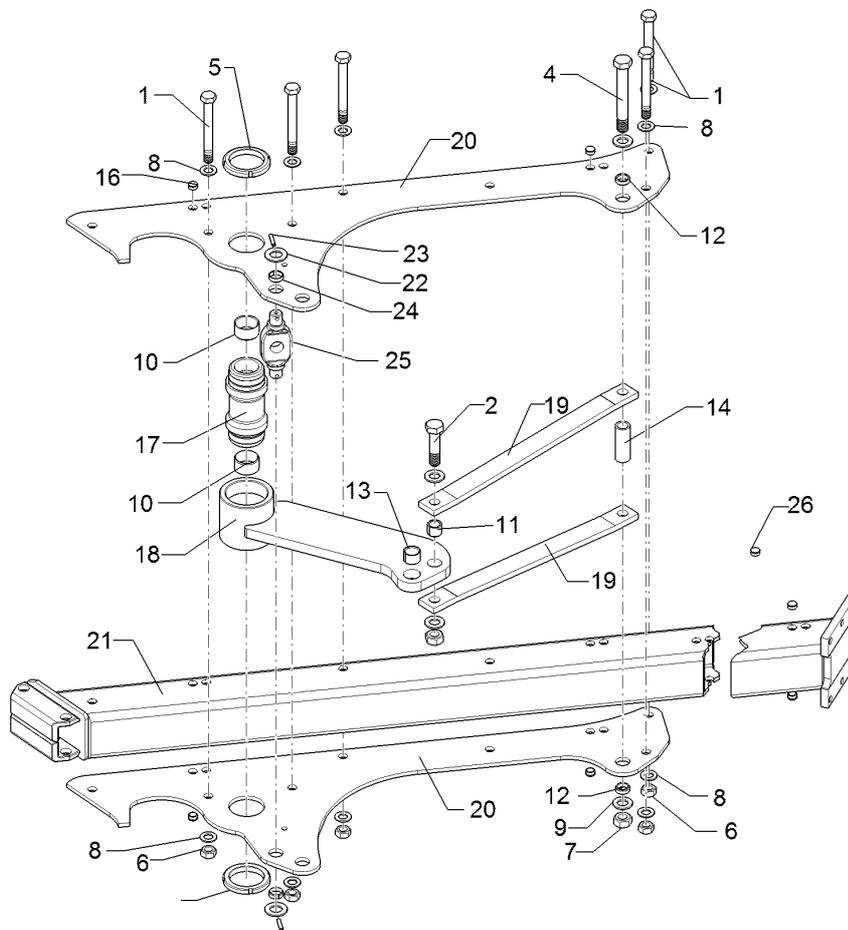

01.18

Pos.	Art.Nr.	Stck.	Artikeltext / Description		Abmessung
1	301 4523	5	Sechskantschraube spezial	Hexagon bolt	M20x1,5x170ls144xb23-10.9 Zn
2	301 4646	1	Sechskantschraube spz.	Hexagon bolt	M24x95-8.8 Zn
4	301 4802	1	Sechskantschraube spz.	Hexagon bolt	M24x180-10.9 Zn
5	303 0341	2	Nutmutter	Grooved nut	M80x2 KM16 Zn
6	303 0977	5	Sechskantmutter	Hexagon nut	M20x1,5 DIN934-10 Zn
7	303 1019	2	Sechskantmutter	Hexagon nut	M24 DIN934-8 Zn
8	305 6012	10	Scheibe	Washer	21 ISO7089 Zn
9	305 6254	4	Scheibe	Washer	D25/44x4 Zn ISO7089
10	317 2025	2	Einspannbuchse mit Presssitz	Expansion bush	EG50/55x30
11	317 3404	1	Einspannbuchse mit Presssitz	Expansion bush	EG24/32x25
12	317 3406	2	Einspannbuchse mit Presssitz	Expansion bush	EG24/32x10
13	317 3417	1	Einspannbuchse mit Presssitz	Expansion bush	EG30/38x25
14	317 6655	1	Röhrchen	Tube	33,7x4,5x90 Zn
16	323 8071	8	Schutzkappe	Cap	GPN 300V19 - D20 RAL5015
17	402 1282	1	Lagerrohr	Bearing tube	D50/M80/93x119x199,5 Zn
18	40210041	1	Schwinge	Rocker arm	D93,5x118 J7M
19	402 1800	2	Strebe	Strut	50x15x705 2xD24,1-655
20	40210040	2	Lagerplatte	Bearing plate	GEK32,5 J7M-100 10x454x1455

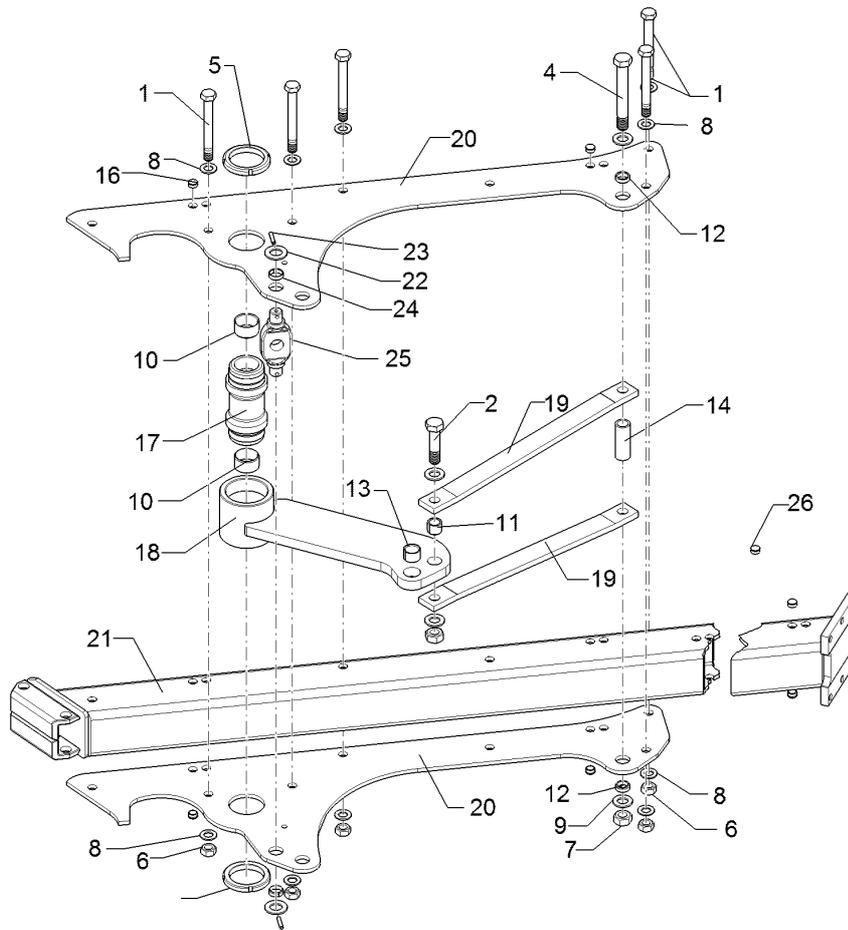

01.18

Pos.	Art.Nr.	Stck.	Artikeltext / Description		Abmessung
21	40210012	1	Grundrahmen	Basic frame	Juwel 7(T) 3-100
22	305 6283	2	Scheibe	Washer	B28 DIN125
23	309 6072	2	Spannhülse	Expansion bush	8x40-DIN1481 Zn
24	317 3347	2	Einspannbuchse mit Presssitz	Expansion bush	EG28/32x10
25	402 1709	1	Kreuzgelenk	Cross union	VO7 70x38x173 D30 Z28 Zn

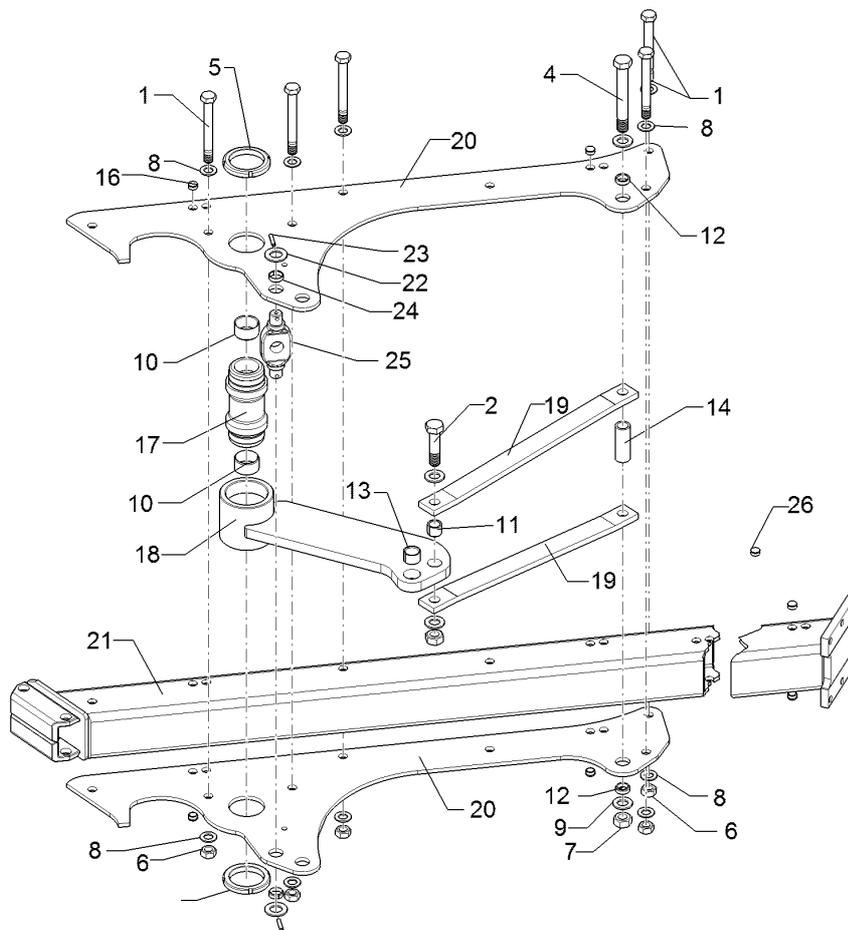

01.18

Pos.	Art.Nr.	Stck.	Artikeltext / Description		Abmessung
1	301 4523	5	Sechskantschraube spezial	Hexagon bolt	M20x1,5x170ls144xb23-10.9 Zn
2	301 4646	1	Sechskantschraube spz.	Hexagon bolt	M24x95-8.8 Zn
4	301 4802	1	Sechskantschraube spz.	Hexagon bolt	M24x180-10.9 Zn
5	303 0341	2	Nutmutter	Grooved nut	M80x2 KM16 Zn
6	303 0977	5	Sechskantmutter	Hexagon nut	M20x1,5 DIN934-10 Zn
7	303 1019	2	Sechskantmutter	Hexagon nut	M24 DIN934-8 Zn
8	305 6012	10	Scheibe	Washer	21 ISO7089 Zn
9	305 6254	4	Scheibe	Washer	D25/44x4 Zn ISO7089
10	317 2025	2	Einspannbuchse mit Presssitz	Expansion bush	EG50/55x30
11	317 3404	1	Einspannbuchse mit Presssitz	Expansion bush	EG24/32x25
12	317 3406	2	Einspannbuchse mit Presssitz	Expansion bush	EG24/32x10
13	317 3417	1	Einspannbuchse mit Presssitz	Expansion bush	EG30/38x25
14	317 6655	1	Röhrchen	Tube	33,7x4,5x90 Zn
16	323 8071	10	Schutzkappe	Cap	GPN 300V19 - D20 RAL5015
17	402 1282	1	Lagerrohr	Bearing tube	D50/M80/93x119x199,5 Zn
18	40210041	1	Schwinge	Rocker arm	D93,5x118 J7M
19	402 1800	2	Strebe	Strut	50x15x705 2xD24,1-655
20	40210040	2	Lagerplatte	Bearing plate	GEK32,5 J7M-100 10x454x1455

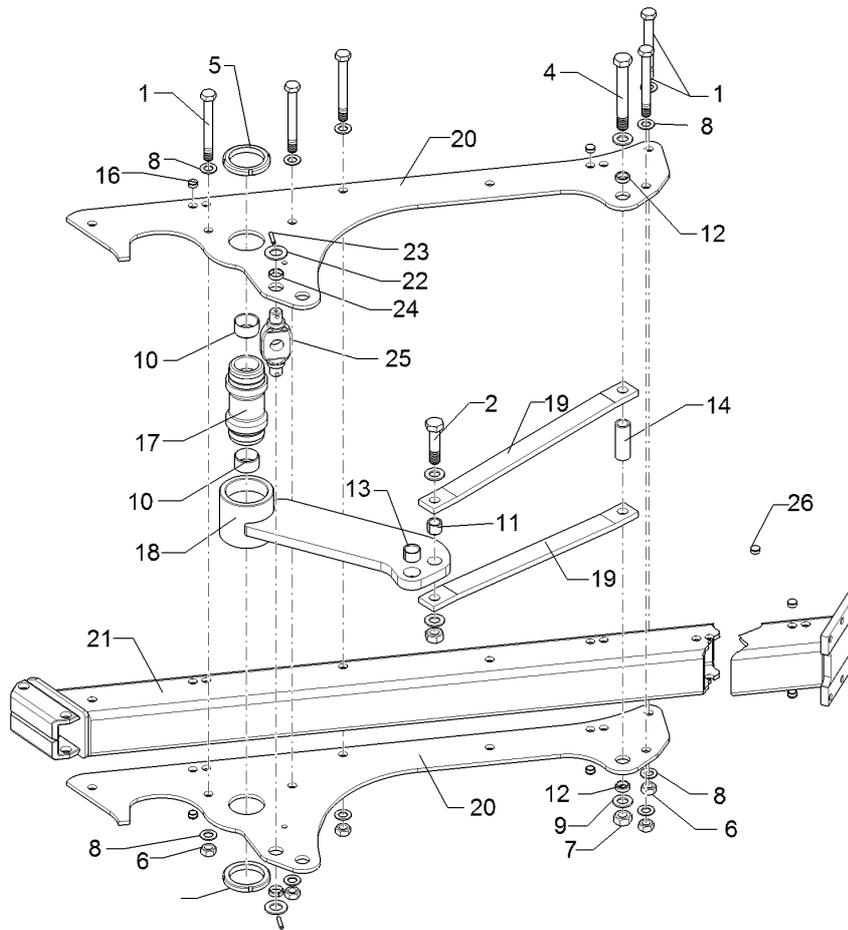

01.18

Pos.	Art.Nr.	Stck.	Artikeltext / Description	Abmessung	
21	40210013	1	Grundrahmen	Basic frame	Juwel 7(T) 4-100
22	305 6283	2	Scheibe	Washer	B28 DIN125
23	309 6072	2	Spannhülse	Expansion bush	8x40-DIN1481 Zn
24	317 3347	2	Einspannbuchse mit Presssitz	Expansion bush	EG28/32x10
25	402 1709	1	Kreuzgelenk	Cross union	VO7 70x38x173 D30
26	323 8053	6	Schutzkappe	Cap	Z28 Zn GPN 300 F 19 RAL5015

Körperhalm/Leg	4
----------------	---

Juwel 7M	464 5007
----------	----------

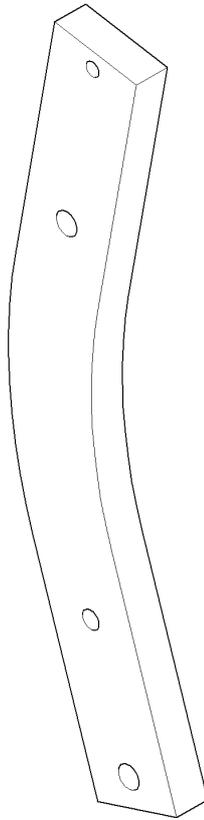

01.18

Pos.	Art.Nr.	Stck.	Artikeltext / Description		Abmessung
1	464 5007	1	Körperhalm	Leg	80x30x745-R850 3xD20,1 1xD14,2

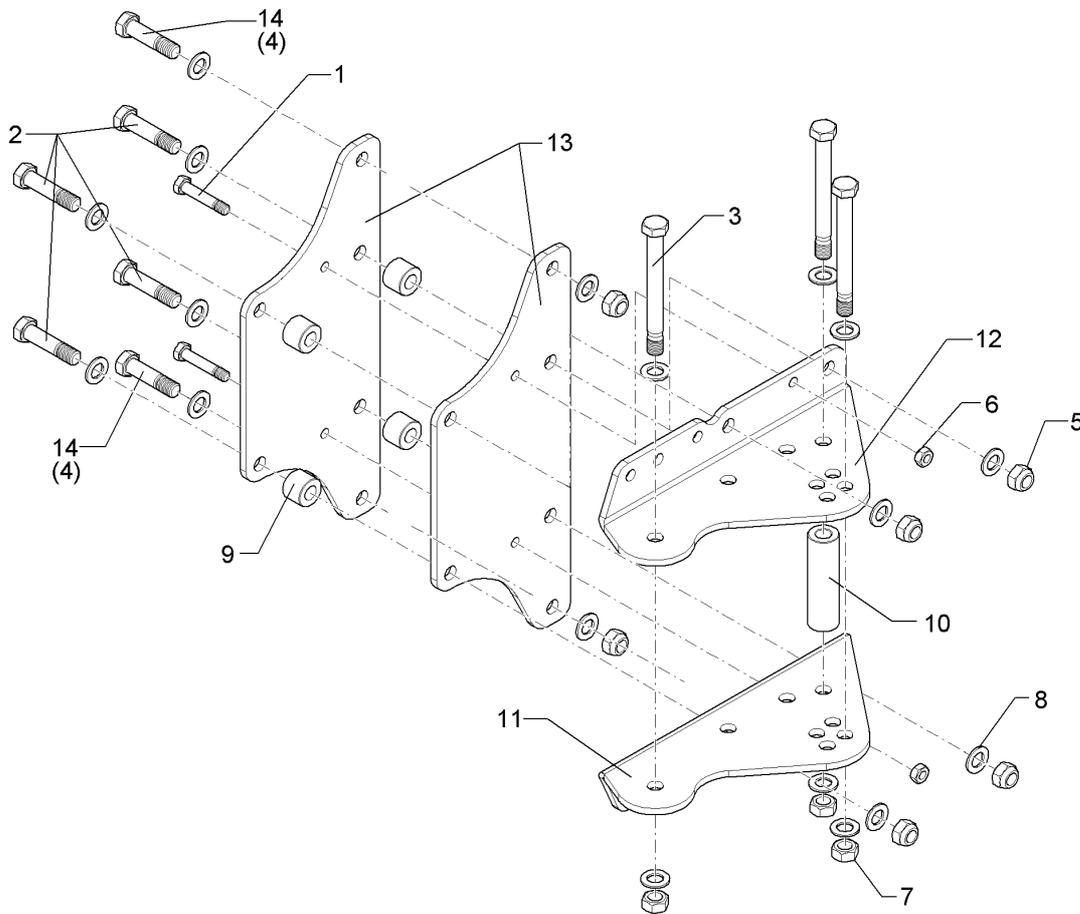

01.18

Pos.	Art.Nr.	Stck.	Artikeltext / Description		Abmessung
1	301 3596	2	Sechskantschraube spz.	Hexagon bolt	M14x75-8.8 Zn
2	301 4607	4	Sechskantschraube spz.	Hexagon bolt	M20x90-12.9 Zn
3	301 4523	3	Sechskantschraube spezial	Hexagon bolt	M20x1,5x170ls144xb23-10.9 Zn
4	301 4370	2	Sechskantschraube spz.	Hexagon bolt	M20x85-10.9 Zn
5	303 0936	6	Sicherungsmutter	Selflocking nut	NM20-8 Zn DIN985
6	303 0974	2	Sechskantmutter	Hexagon nut	M14 DIN934-8
7	303 0977	3	Sechskantmutter	Hexagon nut	M20x1,5 DIN934-10 Zn
8	305 6012	18	Scheibe	Washer	21 ISO7089 Zn
9	317 6944	4	Buchse	Bush	D40/20,2x30,5 Zn
10	317 7510	1	Distanzbuchse	Distance bush	D40/20,2x120 Zn
11	40210030	1	Verstellwinkel	Adjusting bracket	10x210x460 RE
12	40210031	1	Verstellwinkel	Adjusting bracket	Juwel 7 3.K+x.K 10x210x460 LI Juwel 7 3.K+x.K
13	40210005	2	Halmpatte	Plate	10x236x560 Juwel 7
14	301 4606	2	Sechskantschraube spz.	Hexagon bolt	M20x80-10.9 Zn

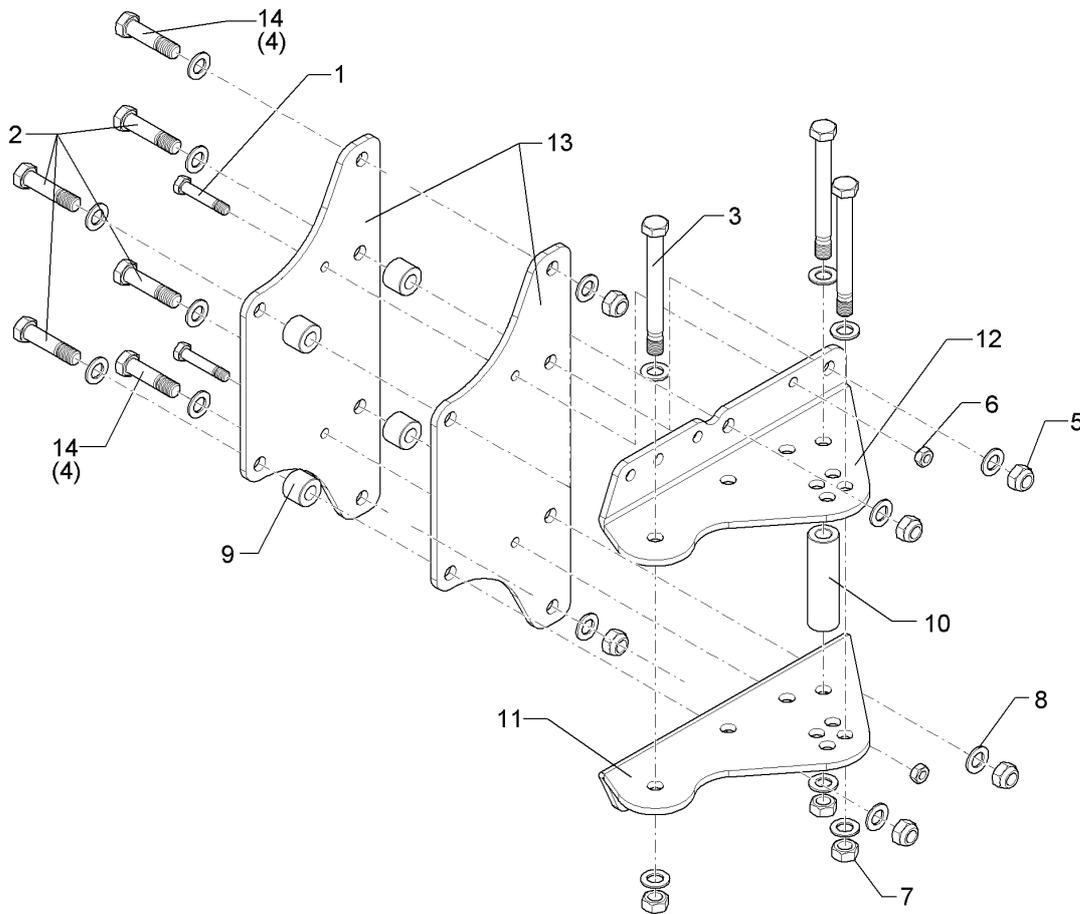

01.18

Pos.	Art.Nr.	Stck.	Artikeltext / Description		Abmessung
1	301 3596	2	Sechskantschraube spz.	Hexagon bolt	M14x75-8.8 Zn
2	301 4607	4	Sechskantschraube spz.	Hexagon bolt	M20x90-12.9 Zn
3	301 4539	3	Sechskantschraube spezial	Hexagon bolt	M20x1,5x190s164xb23-10.9 Zn
4	301 4370	2	Sechskantschraube spz.	Hexagon bolt	M20x85-10.9 Zn
5	303 0936	6	Sicherungsmutter	Selflocking nut	NM20-8 Zn DIN985
6	303 0974	2	Sechskantmutter	Hexagon nut	M14 DIN934-8
7	303 0977	3	Sechskantmutter	Hexagon nut	M20x1,5 DIN934-10 Zn
8	305 6012	18	Scheibe	Washer	21 ISO7089 Zn
9	317 6944	4	Buchse	Bush	D40/20,2x30,5 Zn
10	317 7511	1	Distanzbuchse	Distance bush	D40/20,2x140 Zn
11	40210032	1	Verstellwinkel	Adjusting bracket	10x210x460 RE
12	40210033	1	Verstellwinkel	Adjusting bracket	Juwel 7 1.K+2.K 10x210x460 LI Juwel 7 1.K+2.K
13	40210005	2	Halmpatte	Plate	10x236x560 Juwel 7
14	301 4606	2	Sechskantschraube spz.	Hexagon bolt	M20x80-10.9 Zn

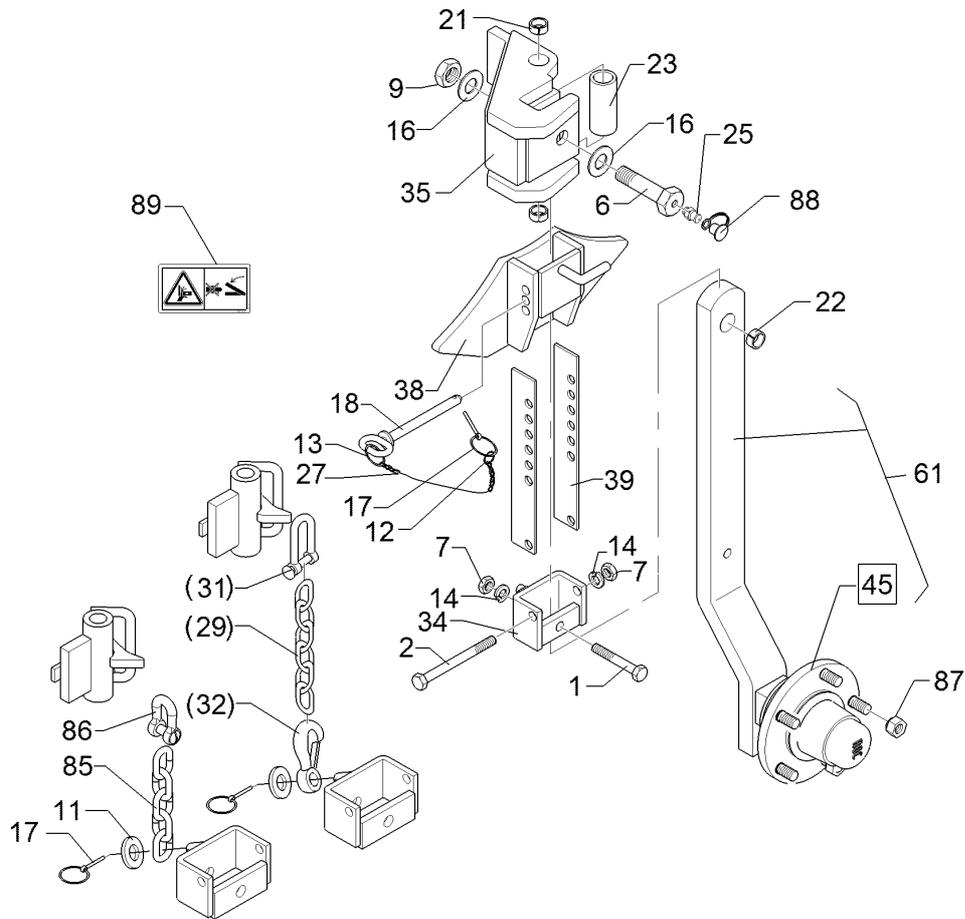

01.18

Pos.	Art.Nr.	Stck.	Artikeltext / Description		Abmessung
1	301 3391	1	Sechskantschraube spz.	Hexagon bolt	M12x60-10.9 Zn
2	301 3462	1	Sechskantschraube	Hexagon bolt	M12x100-8.8 Zn DIN931-A
6	301 4604	1	Sechskantschraube	Hexagon bolt	M20x75 MSB Zn
7	303 1013	2	Sechskantmutter	Hexagon nut	M12 DIN934-8 Zn
9	303 0978	1	Sechskantmutter	Hexagon nut	M20 DIN934-8 Zn
11	305 6141	1	Scheibe	Washer	17/30x3 DIN/ISO-7089
12	305 8545	1	Sicherungsring	Retaining ring	3x30-35x1,25 Zn
13	305 8551	1	Sicherungsring	Retaining ring	Di41x3 A2
14	305 8580	2	Scheibe	Washer	13/24x2,5 St-Zn DIN125
16	305 6012	2	Scheibe	Washer	21 ISO7089 Zn
17	311 9565	2	Klappstift	Securing pin	4,5
18	313 8137	1	Bolzen mit Griff	Pin with grip	D12x103,5/118 Zn
21	317 3358	2	Einspannbuchse DIN 1498	Expansion bush	EG20/26x16
22	317 3394	1	Einspannbuchse	Expansion bush	EG20/26x25-DIN1498
23	317 6664	1	Röhrchen	Tube	33,7x4,5x79 Zn
25	323 6348	1	Schmiernippel	Grease nipple	AM10x1 DIN71412
27	331 6130	1	Knotenkette	Knotted-link chain	D2x150
29	331 6246	1	Kette	Chain	G8x32 DIN5685 6GL 21MN4 Zn-V
31	331 8381	1	Kettenschäkel hochfest	Chain shackle	8x13x27 LA0302
32	331 9012	1	Haken	Hook	D16x90
34	448 2599	1	Halter mit Zapfen	Holder with pivot	27x71

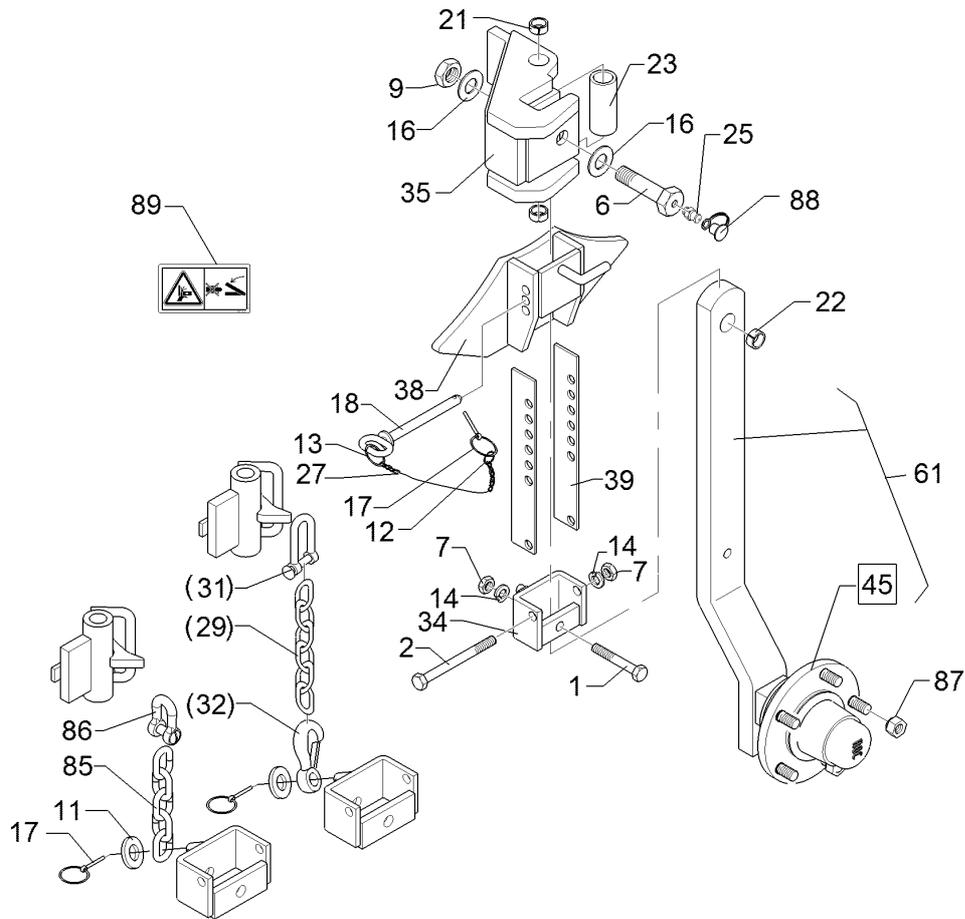

01.18

Pos.	Art.Nr.	Stck.	Artikeltext / Description	Abmessung	
35	448 2601	1	Kreuzgelenk	Cross union	D20x119 E7
38	448 2602	1	Anschlag	Stop	70x42 E7
39	448 2607	2	Verstelleiste	Adjuster plate	40x4x270 7xD13
45	549 8893	1	Lagerung	Bearing	5/93,5/140 M14 50x50
61	548 2608	1	Radhalm	Wheel stalk	60x25x735/615 Pendelrad
85	331 6277	1	Kette	Chain	G10x50 5 Gl. DIN 5685
86	331 8406	1	Schäkel	Shackle	B 0,6 DIN 82101 Zn
87	303 6413	5	Kugelbundmutter	Wheel nut	M14x1,5-8 Zn DIN74361
88	323 6401	2	Schutzkappe	Cap	M6-M10
89	390 0506	1	Aufkleber Warnbildzeichen	Warning Label	Quetschgefahr QF

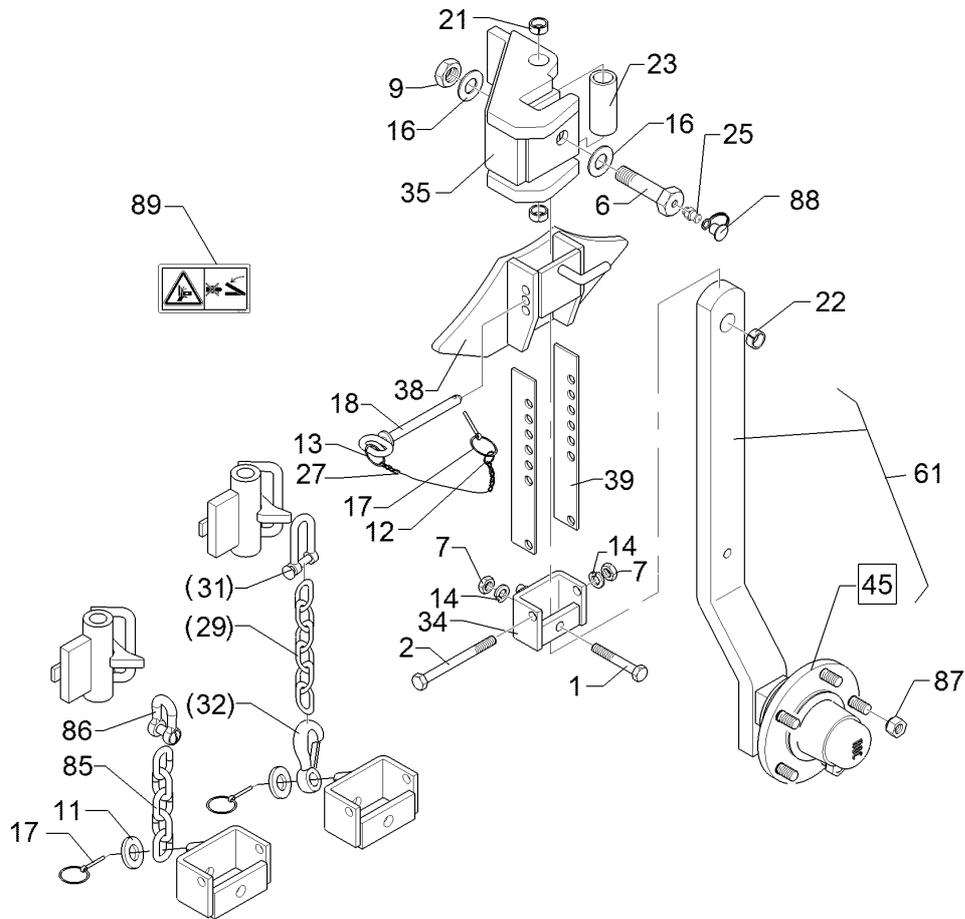

01.18

Pos.	Art.Nr.	Stck.	Artikeltext / Description		Abmessung
1	301 3391	1	Sechskantschraube spz.	Hexagon bolt	M12x60-10.9 Zn
2	301 3462	1	Sechskantschraube	Hexagon bolt	M12x100-8.8 Zn DIN931-A
6	301 4604	1	Sechskantschraube	Hexagon bolt	M20x75 MSB Zn
7	303 1013	2	Sechskantmutter	Hexagon nut	M12 DIN934-8 Zn
9	303 0978	1	Sechskantmutter	Hexagon nut	M20 DIN934-8 Zn
11	305 6141	1	Scheibe	Washer	17/30x3 DIN/ISO-7089
12	305 8545	1	Sicherungsring	Retaining ring	3x30-35x1,25 Zn
13	305 8551	1	Sicherungsring	Retaining ring	Di41x3 A2
14	305 8580	2	Scheibe	Washer	13/24x2,5 St-Zn DIN125
16	305 6012	2	Scheibe	Washer	21 ISO7089 Zn
17	311 9565	2	Klappstift	Securing pin	4,5
18	313 8137	1	Bolzen mit Griff	Pin with grip	D12x103,5/118 Zn
21	317 3358	2	Einspannbuchse DIN 1498	Expansion bush	EG20/26x16
22	317 3394	1	Einspannbuchse	Expansion bush	EG20/26x25-DIN1498
23	317 6664	1	Röhrchen	Tube	33,7x4,5x79 Zn
25	323 6348	1	Schmiernippel	Grease nipple	AM10x1 DIN71412
27	331 6130	1	Knotenkette	Knotted-link chain	D2x150
29	331 6246	1	Kette	Chain	G8x32 DIN5685 6GL 21MN4 Zn-V
31	331 8381	1	Kettenschäkel hochfest	Chain shackle	8x13x27 LA0302
32	331 9012	1	Haken	Hook	D16x90
34	448 2599	1	Halter mit Zapfen	Holder with pivot	27x71

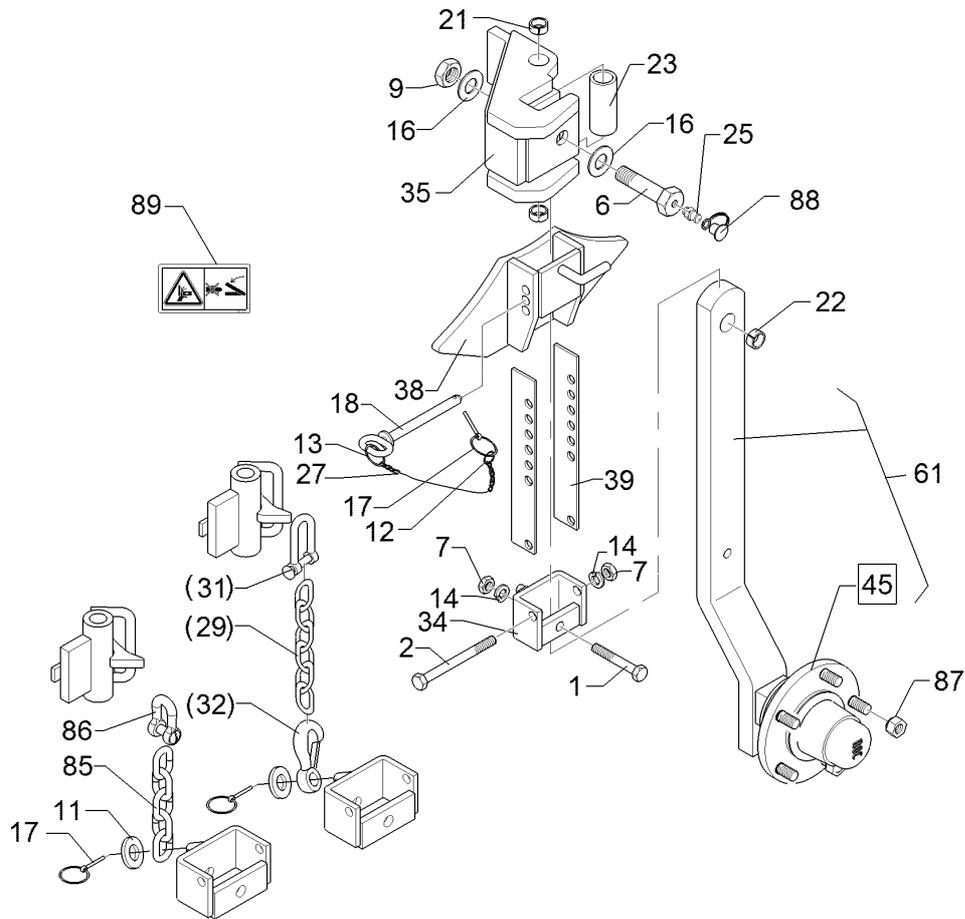

01.18

Pos.	Art.Nr.	Stck.	Artikeltext / Description	Abmessung	
35	448 2601	1	Kreuzgelenk	Cross union	D20x119 E7
38	448 2602	1	Anschlag	Stop	70x42 E7
39	448 2607	2	Verstelleiste	Adjuster plate	40x4x270 7xD13
45	549 8893	1	Lagerung	Bearing	5/93,5/140 M14 50x50
61	548 2607	1	Radhalm	Wheel stalk	60x25x675/550 Pendelrad
85	331 6277	1	Kette	Chain	G10x50 5 Gl. DIN 5685
86	331 8406	1	Schäkel	Shackle	B 0,6 DIN 82101 Zn
87	303 6413	5	Kugelbundmutter	Wheel nut	M14x1,5-8 Zn DIN74361
88	323 6401	2	Schutzkappe	Cap	M6-M10
89	390 0506	1	Aufkleber Warnbildzeichen	Warning Label	Quetschgefahr QF

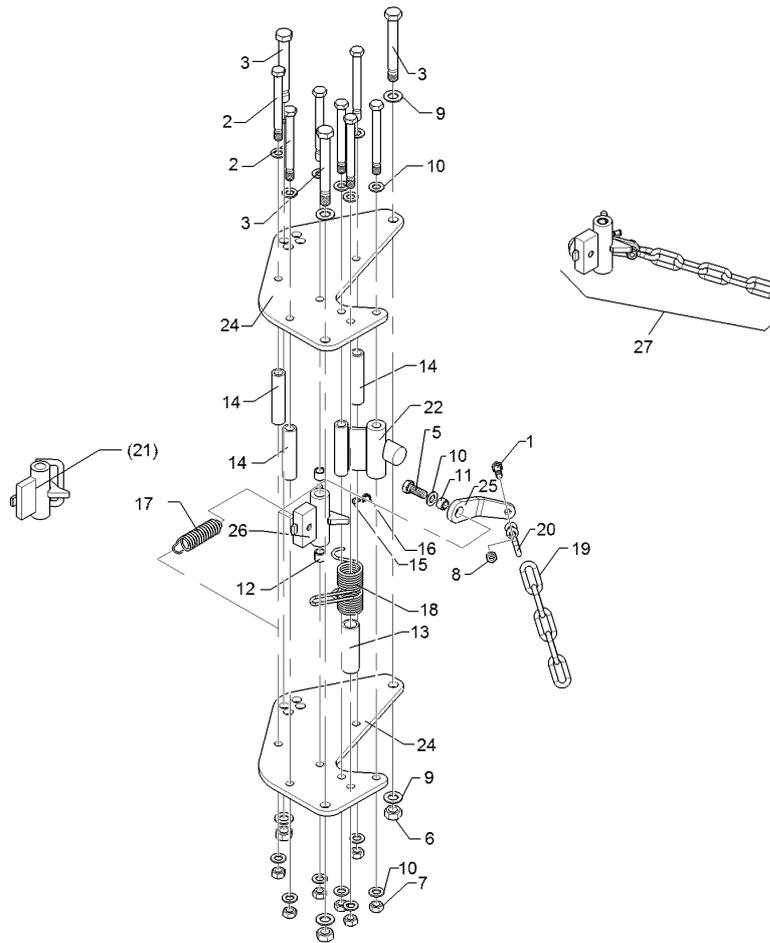

01.18

Pos.	Art.Nr.	Stck.	Artikeltext / Description		Abmessung
1	301 3367	1	Sechskantschraube spz.	Hexagon bolt	M12x45-8.8 Zn
2	301 4118	7	Sechskantschraube	Hexagon bolt	M16x1,5x162ls140xb19-10.9 Zn
3	301 4523	3	Sechskantschraube spezial	Hexagon bolt	M20x1,5x170ls144xb23-10.9 Zn
5	301 5404	1	Sechskantschraube	Hexagon bolt	M16x40-8.8 Zn
6	303 0977	3	Sechskantmutter	Hexagon nut	DIN933 M20x1,5 DIN934-10 Zn
7	303 0990	7	Sechskantmutter	Hexagon nut	M16x1,5 DIN934-10 Zn
8	303 1013	1	Sechskantmutter	Hexagon nut	M12 DIN934-8 Zn
9	305 6012	6	Scheibe	Washer	21 ISO7089 Zn
10	305 6141	15	Scheibe	Washer	17/30x3 DIN/ISO-7089
11	317 3334	1	Einspannbuchse	Expansion bush	EG16/22x14-DIN1498
12	317 3336	2	Einspannbuchse	Expansion bush	EG16/22x18-DIN1498
13	317 6660	1	Röhrchen	Tube	33,7x4,5x110 Zn
14	317 6859	3	Röhrchen	Tube	D26,9x4,5x119,3 Zn
15	323 6348	1	Schmiernippel	Grease nipple	AM10x1 DIN71412
16	323 6401	1	Schutzkappe	Cap	M6-M10
17	329 8496	1	Zugfeder	Spring	2,8x27,2x91 D35/12
18	329 9041	1	Drehfeder	Torsion spring	d=5,5 Dm=46
19	331 6277	1	Kette	Chain	2-Schenkel Zn G10x50 5 Gl. DIN 5685
20	331 8380	1	Malotte ohne Gewinde	Shackle	D13

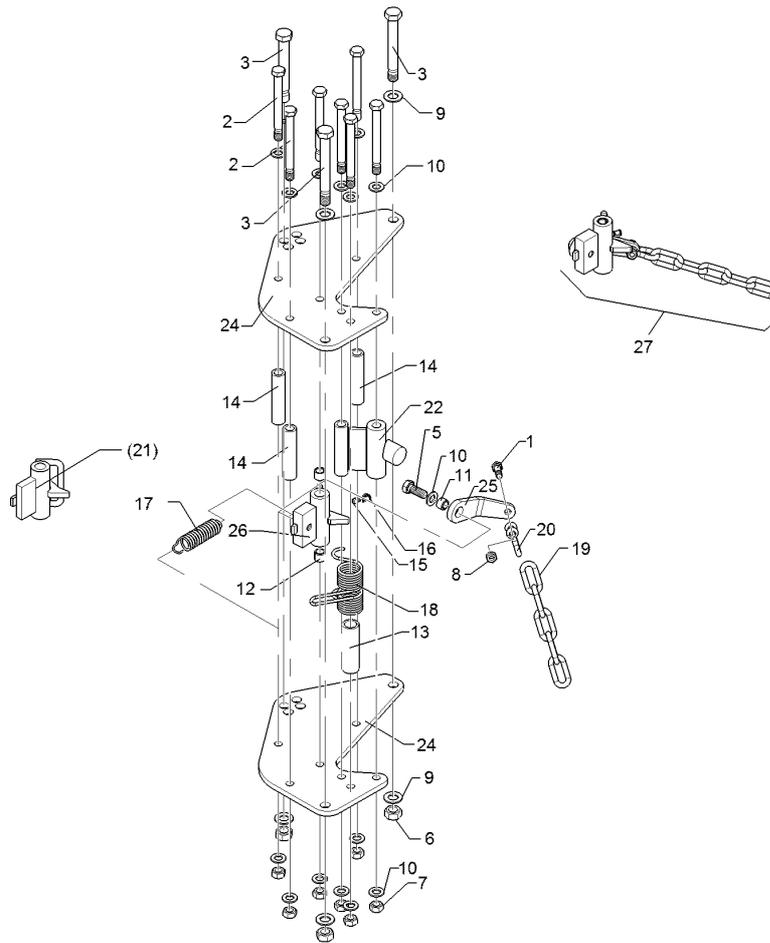

01.18

Pos.	Art.Nr.	Stck.	Artikeltext / Description	Abmessung
21	448 2598	1	Verriegelung mit Bügel	Locking device
22	448 2605	1	Anschlag	Stop
24	448 2604	2	Platte	Plate
25	44810015	1	Hebel	Lever
26	44810016	1	Verriegelung	Locking device
27	54810007	1	Montagesatz	Mounting set
				D38/22x117,5
				60x30 2xD16x119
				12x358x434 E7
				12x46x163 GEB45°
				D23 D13 V
				D38/22x117,5
				Stützrad

Radhalm mit Lagerung/Wheel stalk with bearing	5
---	---

Juwel 7M	54810008
----------	----------

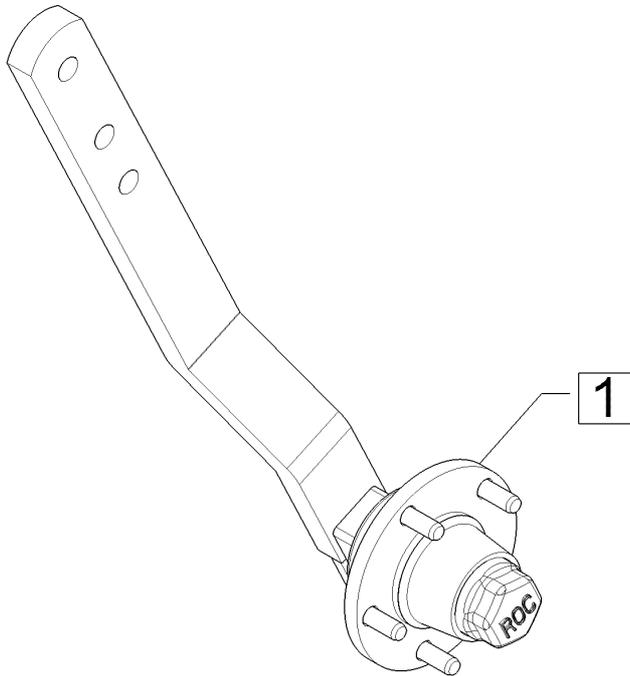

01.18

Pos.	Art.Nr.	Stck.	Artikeltext / Description		Abmessung
1	549 8893	1	Lagerung	Bearing	5/93,5/140 M14 50x50

Rad/Wheel	5
-----------	---

Juwel 7M	549 8849
----------	----------

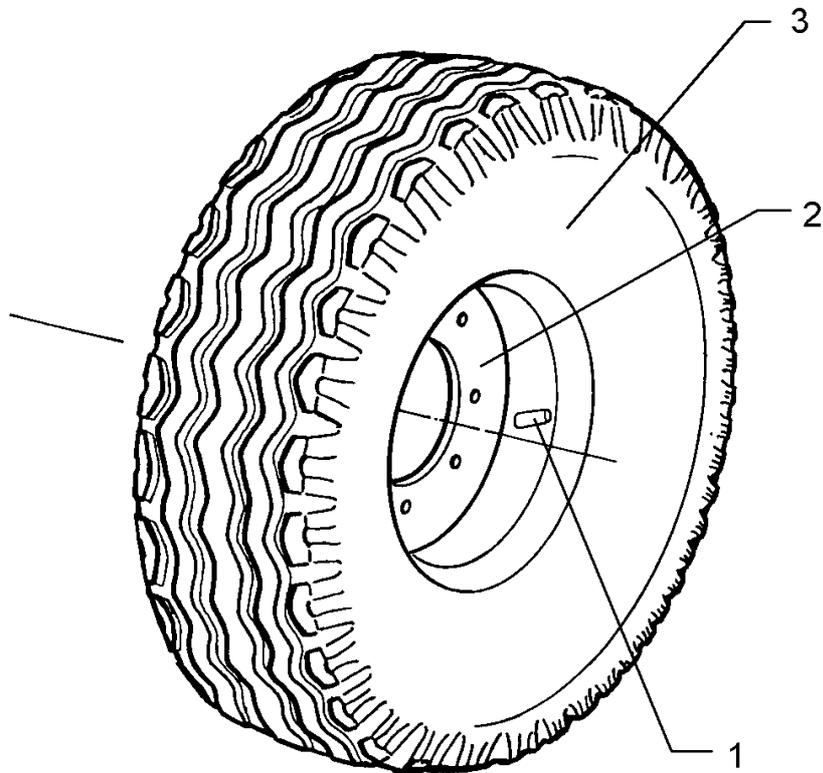

01.18

Pos.	Art.Nr.	Stck.	Artikeltext / Description		Abmessung
1	357 3422	1	Schlauch	Hose	10.0/80-12 TR15
2	357 7069	1	Felge	Rim	7.00x12ET-25 5/94/140
3	357 8856	1	Reifen	Tyre	10.0/80-12 8 PR AW

Rad 5/94/140 D14/Wheel 5/94/140 D14	5
-------------------------------------	----------

Juwel 7M	549 8858
-----------------	-----------------

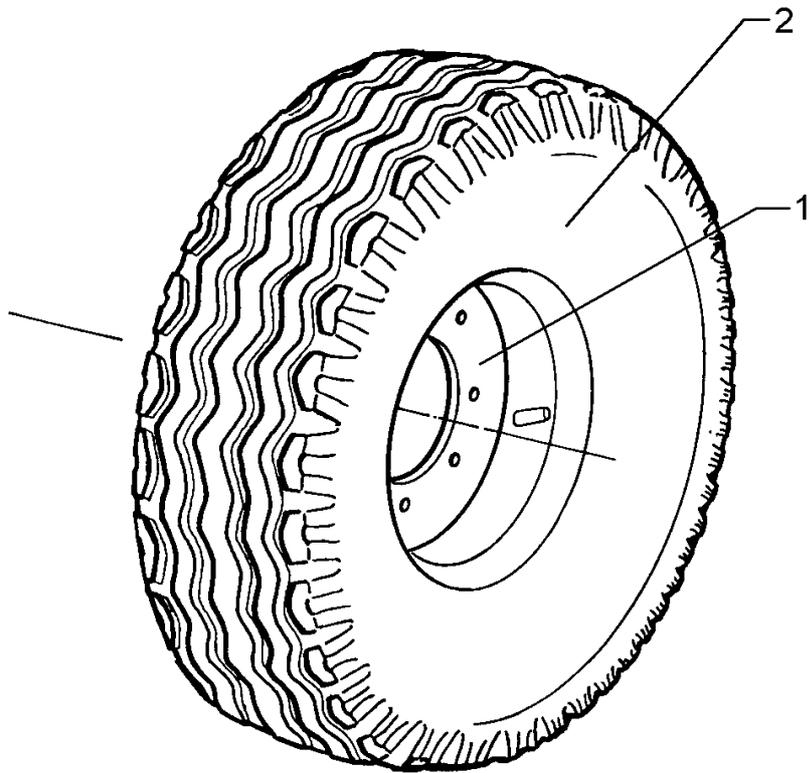

01.18

Pos.	Art.Nr.	Stck.	Artikeltext / Description		Abmessung
1	357 7029	1	Felge	Rim	5Jx15 H2 ET0 5/94/140
2	357 8837	1	Reifen	Tyre	195/65x15 D650x198

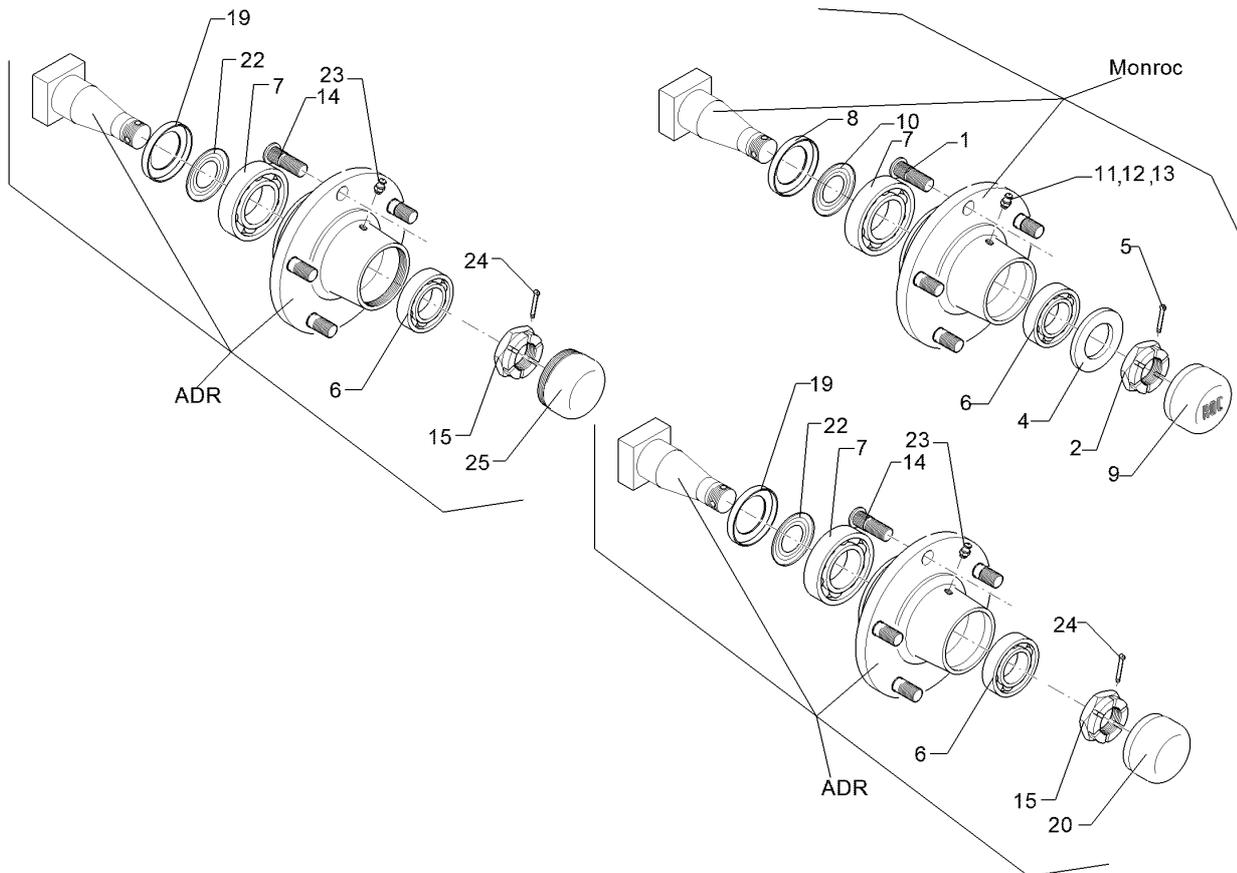

01.18

Pos.	Art.Nr.	Stck.	Artikeltext / Description	Abmessung	
1	301 6414	5	Radbolzen	Wheel bolt	M14x1,5x45 Zn
2	303 0139	1	Kronenmutter	Castle nut	DIN937-M24x2
3	303 6413	5	Kugelbundmutter	Wheel nut	M14x1,5-8 Zn DIN74361
4	305 6254	1	Scheibe	Washer	D25/44x4 Zn ISO7089
5	311 7617	1	Splint	Peg	4x40 DIN94-St Zn
6	319 9116	1	Kegelrollenlager	Tapered roller bearing	30206.
7	319 9151	1	Kegelrollenlager	Tapered roller bearing	30209.
8	323 0413	1	Hüllscheibe	Cover washer	D100/45x12
9	323 1321	1	Schraubkappe	Cap	D63,5x40
10	323 1802	1	Nilos-Ring	Nilos ring	30209 AV
11	323 6345	1	Schmiernippel gerade	Grease nipple	LAM 6 DIN71412
12	323 6353	1	Schmiernippel	Grease nipple	BM8x1,25 DIN71412-6kt. 65 GRD
13	323 6363	1	Schmiernippel	Grease nipple	1/4" SAE
14	301 6416	5	Radschraube	Wheel bolt	M14x1,5x41/45
15	303 0174	1	Kronenmutter	Castle nut	M27x1,5
19	323 7628	1	Dichtung zum Lager	Seal	30209
20	323 1315	1	Schlagkappe	Lug strap	ADR D62x21
21	323 1841	1	Nilos-Ring	Nilos ring	30206 JV
22	323 1844	1	Nilos-Ring	Nilos ring	30209 JV

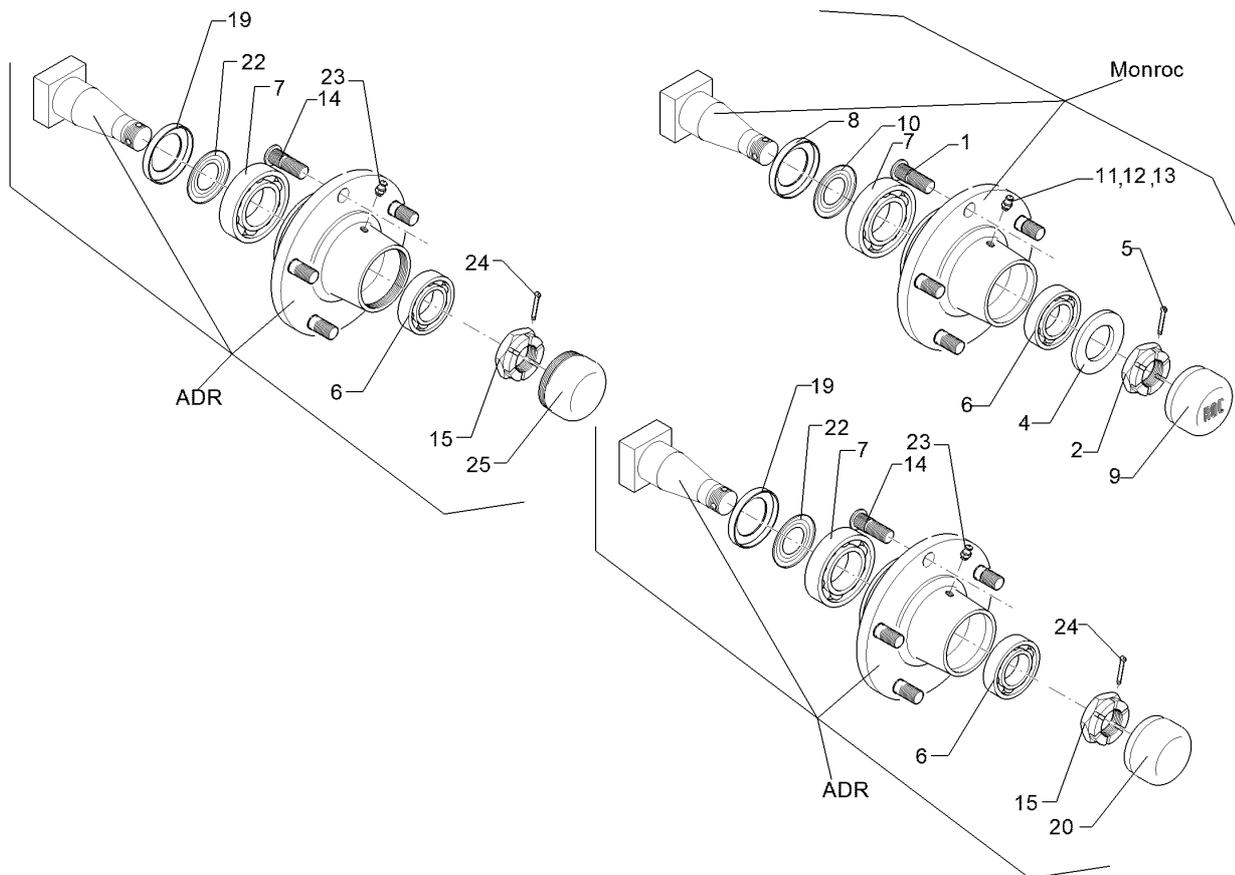

01.18

Pos.	Art.Nr.	Stck.	Artikeltext / Description	Abmessung
23	323 6354	1	Schmiernippel Grease nipple	BM8x1 DIN71412-6kt. 45
24	329 3541	1	Sicherungsklammer Safety clamp	GRD D5x50
25	323 1314	1	Schraubkappe Cap	M64x2 (D62)

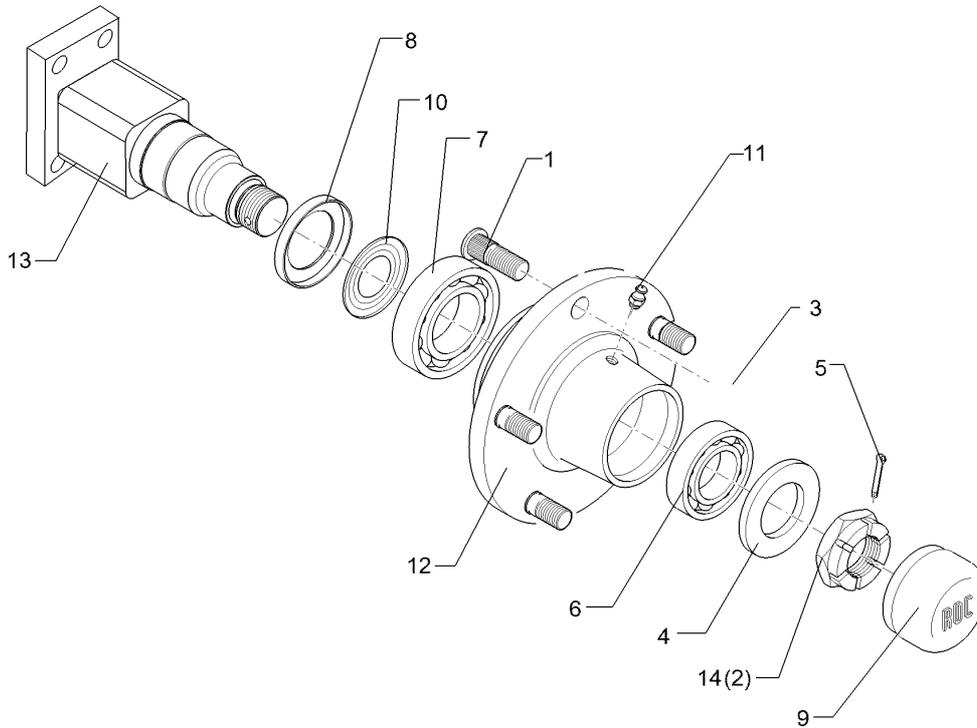

01.18

Pos.	Art.Nr.	Stck.	Artikeltext / Description		Abmessung
1	30110079	6	Radschraube	Wheel bolt	M18x1,5x54
2	303 0141	1	Kronenmutter	Castle nut	DIN935-M30x1,5
4	305 6285	1	Scheibe	Washer	31/56x4 DIN/ISO-7089 Zn
5	311 7635	1	Splint	Peg	5x45 DIN94-St Zn
6	319 9015	1	Kegelrollenlager	Tapered roller bearing	30207
7	319 9019	1	Kegelrollenlager	Tapered roller bearing	30211.
8	323 0414	1	Schutzkappe	Cap	D110x10
9	323 1322	1	Schraubkappe	Cap	D73x40
10	323 1803	1	Nilos-Ring	Nilos ring	30211 AV
11	323 6345	1	Schmiernippel gerade	Grease nipple	LAM 6 DIN71412
12	449 8893	1	Nabe	Hub	6/205 ROC
13	44910021	1	Flanschachse	Flange axle	70x70x234 4xD16,3 110x50
14	30310017	1	Kronenmutter	Castle nut	M30x2 h=18

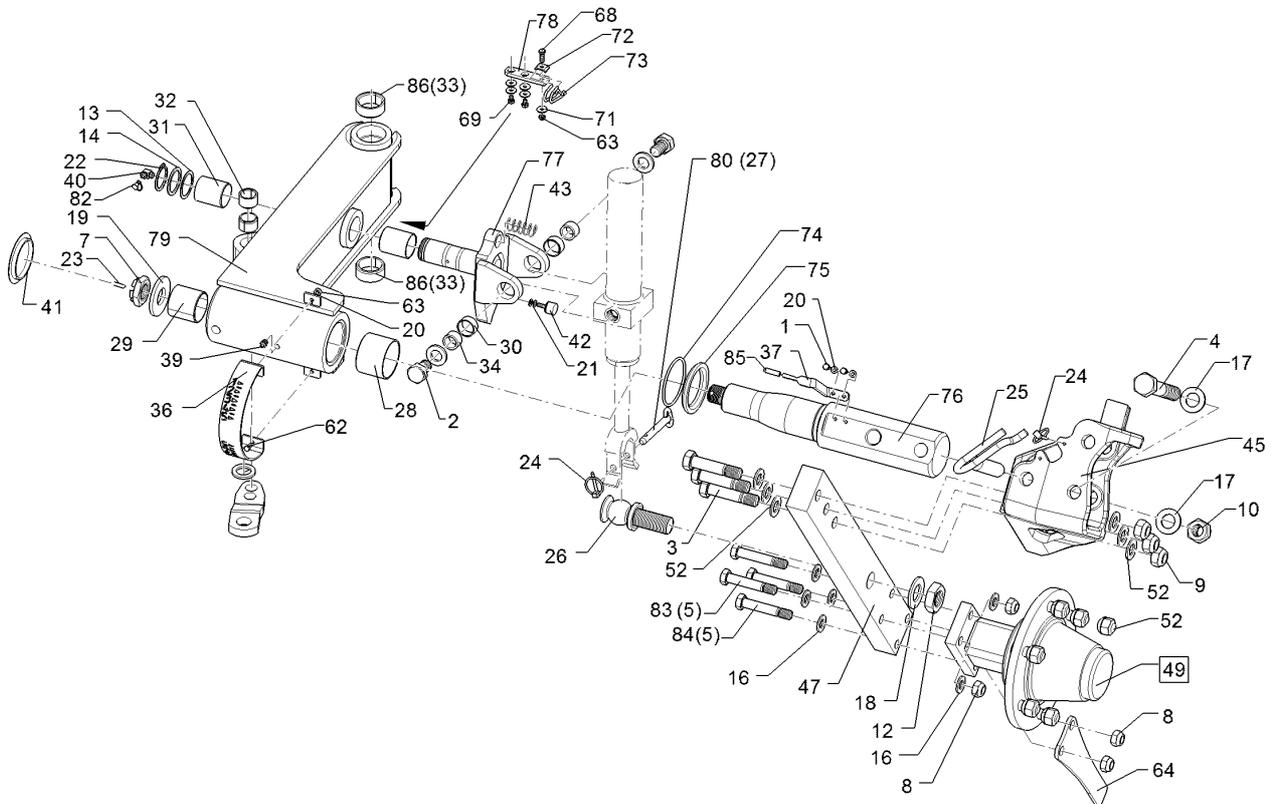

01.18

Pos.	Art.Nr.	Stck.	Artikeltext / Description		Abmessung
1	301 3001	2	Sechskantschraube	Hexagon bolt	M6x12-8.8 Zn DIN933
2	301 4238	2	Sechskantschraube	Hexagon bolt	M20x1,5x30 Zn DIN961
3	301 4607	3	Sechskantschraube spz.	Hexagon bolt	M20x90-12.9 Zn
4	301 4700	1	Sechskantschraube	Hexagon bolt	M24x140-8.8 DIN931-A
5	301 5370	4	Sechskantschraube spz.	Hexagon bolt	M16x90-12.9 Zn
7	303 0142	1	Kronenmutter	Castle nut	DIN937-M30x1,5
8	303 0935	4	Sicherungsmutter	Selflocking nut	NM16-8 Zn DIN985
9	303 0936	3	Sicherungsmutter	Selflocking nut	NM20-8 Zn DIN985
10	303 0937	1	Sicherungsmutter	Selflocking nut	NM24-8 Zn DIN985
12	303 0994	1	Sechskantmutter	Hexagon nut	M30x1,5 DIN439-05 Zn
13	305 2095	1	Passscheibe	Shim	40x50x1,0 DIN988 Zn
14	305 2250	1	Stützscheibe	Supporting washer	S 40x50x2,5 DIN988 Zn
16	305 6141	6	Scheibe	Washer	17/30x3 DIN/ISO-7089
17	305 6254	2	Scheibe	Washer	D25/44x4 Zn ISO7089
18	305 6285	1	Scheibe	Washer	31/56x4 DIN/ISO-7089 Zn
19	305 6425	1	Scheibe	Washer	D70/31x6 Zn
20	305 8571	4	Scheibe	Washer	6,4 DIN125-A Zn
21	305 8573	2	Scheibe	Washer	6,5/13x1,25 St-Zn

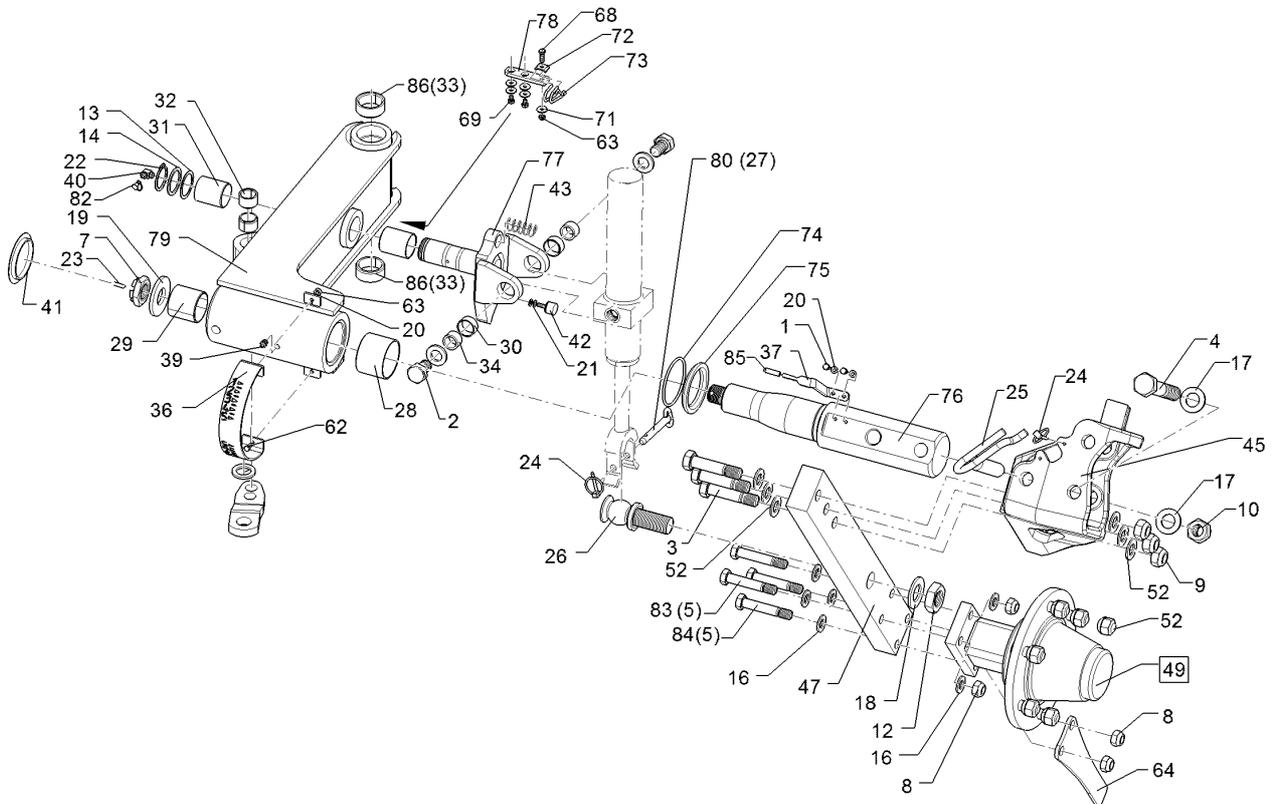

01.18

Pos.	Art.Nr.	Stck.	Artikeltext / Description		Abmessung
22	305 8875	1	Sicherungsring	Retaining ring	40x2,5 DIN471
23	311 7648	1	Splint	Peg	6,3x50 DIN94-St Zn
24	311 9565	2	Klappstift	Securing pin	4,5
25	313 1816	1	Bolzen mit Griff	Pin with grip	D24x113 Zn
26	313 3034	1	Zapfen	Pivot	D48x127,34-M30x1,5 Zn
27	313 8153	1	Bolzen mit Griff	Pin with grip	D12x74,5/115 Zn
28	317 3036	1	Einspannbuchse Kunststoff	Expansion bush	EG65/70x50 GSM
29	317 3037	1	Einspannbuchse Kunststoff	Expansion bush	EG50/55x50 GSM
30	317 3038	2	Einspannbuchse Kunststoff	Expansion bush	EG28/32x15 GSM
31	317 3039	2	Einspannbuchse Kunststoff	Expansion bush	EG40/44x50 GSM
32	317 3413	2	Einspannbuchse	Expansion bush	EG25/32x20 DIN 1498
33	31710183	2	Einspannbuchse	Expansion bush	EG40/50x20 Presssitz
34	317 6984	2	Röhrchen	Tube	D28x3,5x17
36	321 7018	1	Skala	Scale	3x40x327,94 Zn
37	321 7019	1	Tiefenzeiger	Pointer	Juwel 8 5x15x150 2xGEB
38	323 0530	1	Anlaufscheibe	Thrust washer	Juwel 8 68/81x2 SYN
39	323 6348	2	Schmiernippel	Grease nipple	AM10x1 DIN71412
40	323 6349	1	Schmiernippel	Grease nipple	CM10x1 DIN71412-90 GRD
41	323 8054	1	Schutzkappe	Cap	GPN 910/3042 SCHWARZ

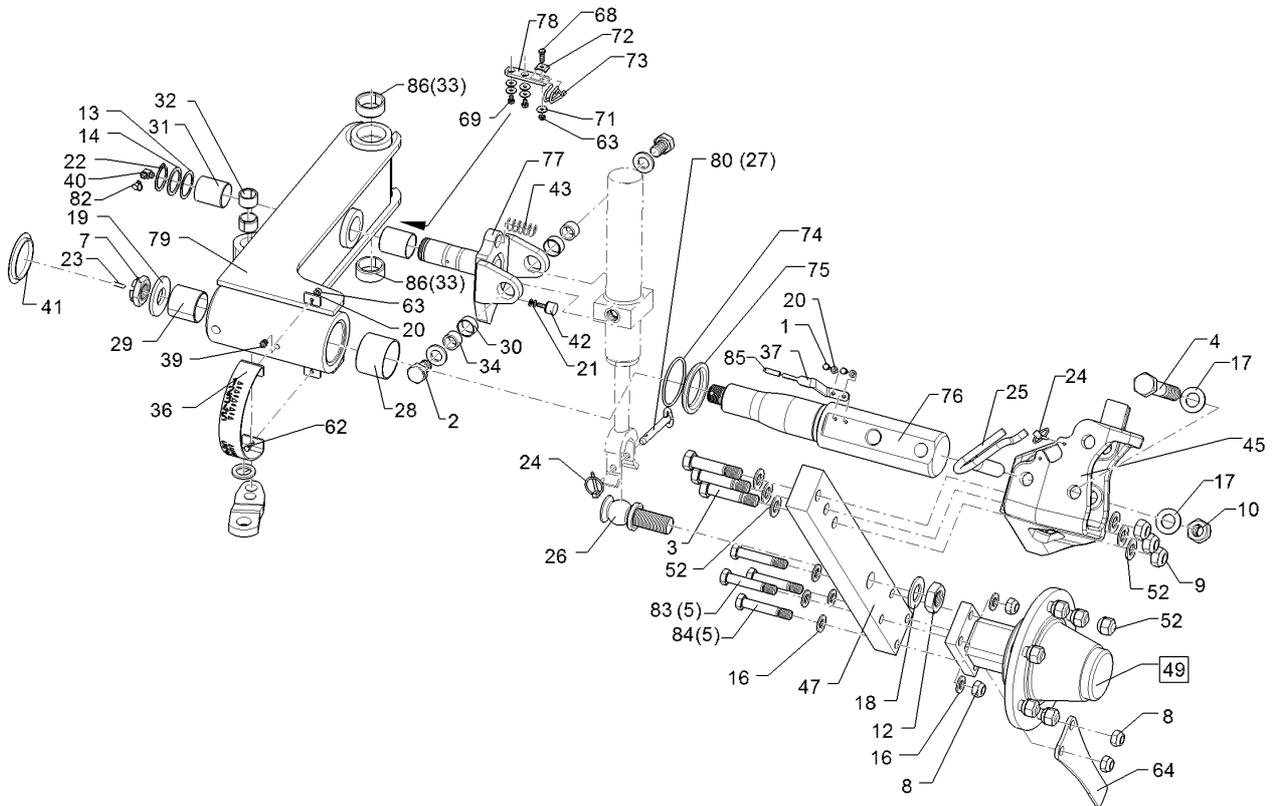

01.18

Pos.	Art.Nr.	Stck.	Artikeltext / Description		Abmessung
42	329 5004	1	Gummipuffer	Rubber buffer	Typ-D D20x15
43	329 8244	1	Druckfeder	Compression spring	M6x18 NR 90Shore
45	449 3001	1	Schwenktasche	Bracket	2x20x55,4 Zn
47	449 3003	1	Radhalm	Wheel stalk	295x288x212 Juwel
49	549 8904	1	Flanschlager	Flange-type bearing	80x40x635
52	305 6012	8	Scheibe	Washer	6/160/205 D18
62	301 3003	2	Sechskantschraube	Hexagon bolt	2xD20
63	303 0931	3	Sicherungsmutter	Selflocking nut	21 ISO7089 Zn
64	449 1644	1	Abstreifer	Scraper	NM6-8 Zn DIN985
69	301 3004	1	Sechskantschraube	Hexagon bolt	8x80x270 2xD17
70	301 3000	2	Sechskantschraube	Hexagon bolt	M6x20-8.8 Zn
71	305 8572	5	Scheibe	Washer	DIN933
72	30510010	1	Sicherungsblech	Locking plate	M6x10-8.8 Zn
73	32910003	1	Federklammer	Clamp	DIN933
74	375 1295	1	O-Ring	O-ring	6,4 DIN9021 Zn
75	44910005	1	Hülse	Bushing	80x4-80Shore
76	44910006	1	Achse	Axle	Viton83
77	44910007	1	Gabel	Fork	D90/66x10
78	44910008	1	Lasche	Lashing	D40 Juwel
79	44910014	1	Schwenkarm	Swinging arm	20x6x78,5
					Unirad Juwel 7

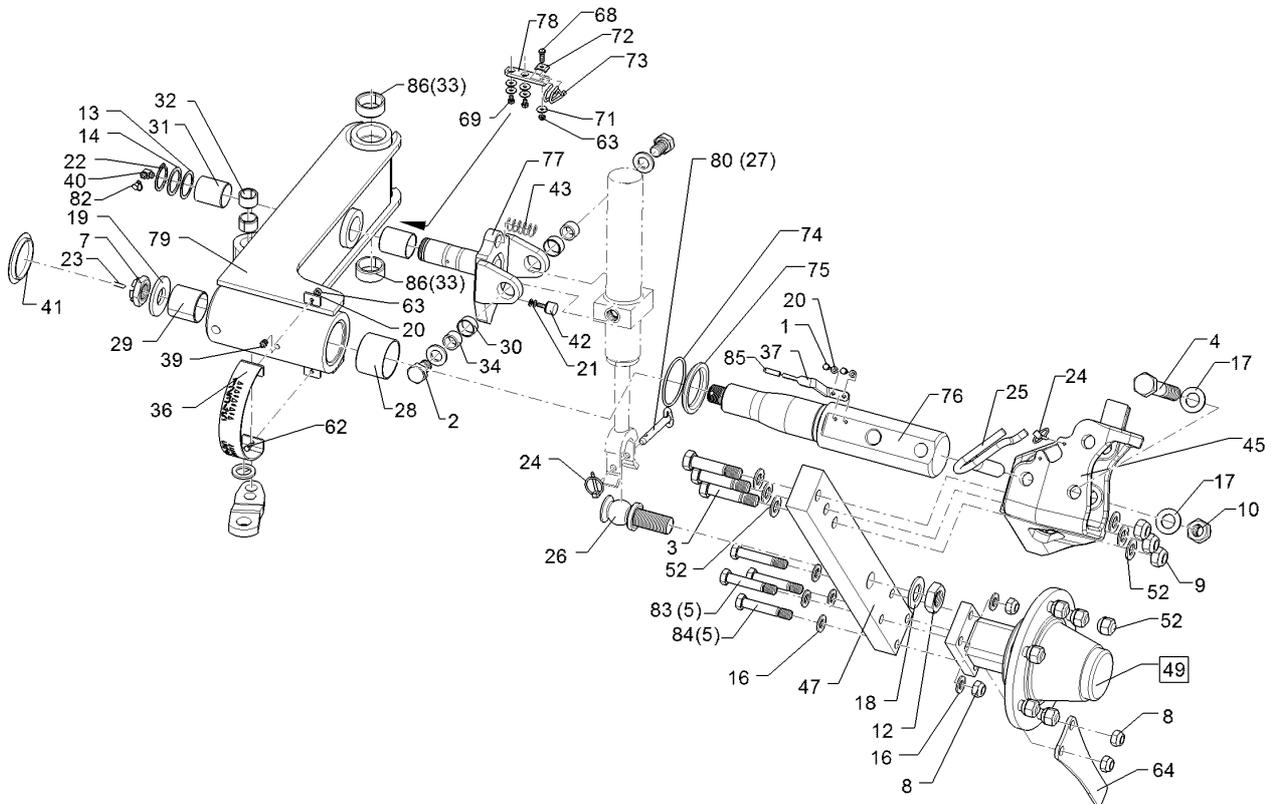

01.18

Pos.	Art.Nr.	Stck.	Artikeltext / Description		Abmessung
80	31310063	1	Bolzen mit Griff	Pin with grip	D14x74,5/115 V Zn
81	303 6416	6	Kugelbundmutter	Wheel nut	M18x1,5-10 Zn DIN 74361
82	323 6401	4	Schutzkappe	Cap	M6-M10
83	301 3959	2	Sechskantschraube	Hexagon bolt	M16x85-8.8 DIN931-A Zn
84	301 3976	2	Sechskantschraube	Hexagon bolt	M16x90-8.8 Zn DIN931-A
85	32310160	1	Schutzkappe	Cap	GPN 255/5 RAL3000
86	31710304	2	Einspannbuchse	Expansion bush	EGPG 50/40x40-CM

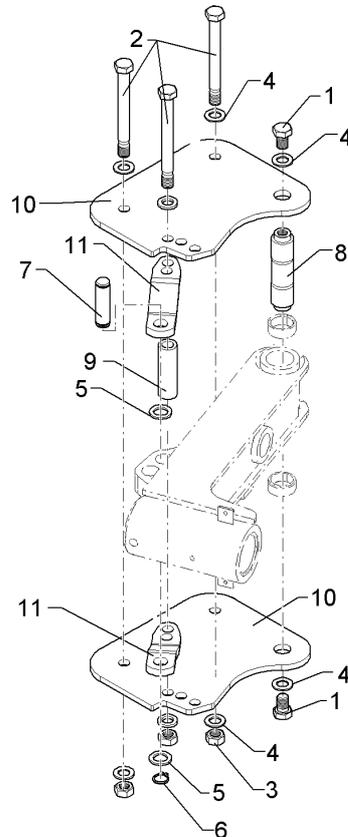

01.18

Pos.	Art.Nr.	Stck.	Artikeltext / Description		Abmessung
1	301 4190	2	Sechskantschraube	Hexagon bolt	M20x30-8.8 Zn DIN933
2	301 4523	3	Sechskantschraube spezial	Hexagon bolt	M20x1,5x170ls144xb23-10.9 Zn
3	303 0977	3	Sechskantmutter	Hexagon nut	M20x1,5 DIN934-10 Zn
4	305 6012	8	Scheibe	Washer	21 ISO7089 Zn
5	305 6254	2	Scheibe	Washer	D25/44x4 Zn ISO7089
6	305 8861	2	Sicherungsring	Retaining ring	25x2 DIN471 Zn
7	313 7793	1	Bolzen	Pin	D25x80,7/95 Zn
8	31310032	1	Bolzen	Pin	D40/30x139 2xM20
9	317 6803	1	Röhrchen	Tube	33,7x6,3x90 Zn
10	44910013	2	Lagerplatte	Bearing plate	10x280x340 Juwel 7 Rad
11	44910015	2	Steuerstange	Control rod	15x50x195,5 GEK25

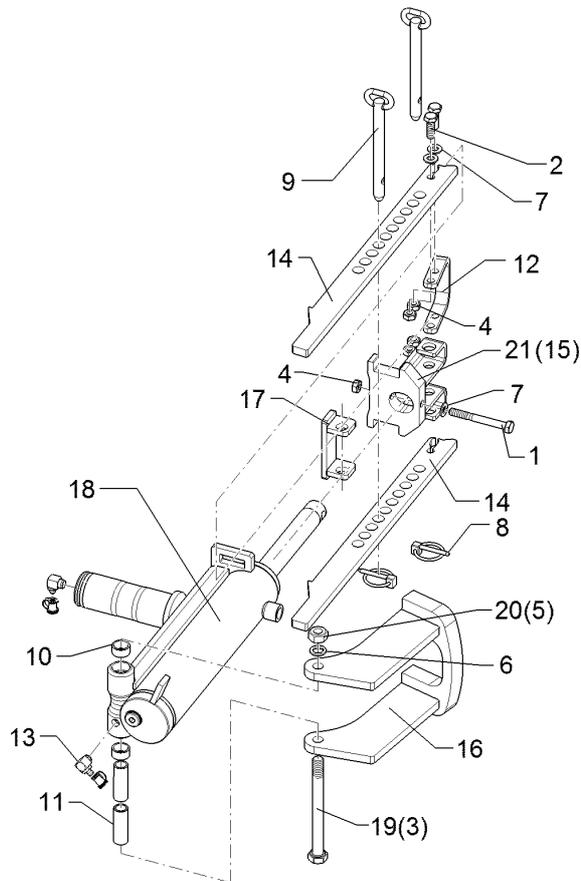

01.18

Pos.	Art.Nr.	Stck.	Artikeltext / Description		Abmessung
1	30110483	1	Sechskantschraube	Hexagon bolt	M8x70-10.9 DIN931 Zn
2	301 7280	4	Sechskantschraube	Hexagon bolt	M8x25-8.8 Zn DIN933
3	30110044	1	Sechskantschraube	Hexagon bolt	M12x130 DIN7990
4	303 1011	5	Sechskantmutter	Hexagon nut	M8 DIN934-8 Zn
5	303 1013	1	Sechskantmutter	Hexagon nut	M12 DIN934-8 Zn
6	305 2009	2	Passscheibe	Shim	12/18x2,0 DIN988 Zn
7	305 8694	5	Scheibe	Washer	A8,4 DIN125-St Zn
8	311 9565	2	Klappstift	Securing pin	4,5
9	31310003	2	Bolzen mit Griff	Pin with grip	D12x95,5/135 Zn
10	317 3299	2	Buchse	Bush	D20/16,05x10
11	317 5263	2	Lagerbuchse	Bearing bush	D16/12,2x45,3
12	32110017	1	Handgriff	Handle	6x35x116,5 2xGEB90° U67
13	323 6349	2	Schmiernippel	Grease nipple	CM10x1 DIN71412-90 GRD
14	44910016	2	Tiefeneinstellung	Depth adjustment	30x10x397 10xD13
15	44910017	1	Gabelstück	Forkpiece	D26/35 92X73
16	44910018	1	Verriegelung	Locking device	D12x166
17	44910019	1	Tiefeneinstellung	Depth adjustment	Unirad 28/31x80 D12,5 Zn
18	575 2577	1	Dämpferzylinder	Ram	D50/25x210
19	301 3519	1	Sechskantschraube	Hexagon bolt	M12x130-8.8 Zn DIN931-A

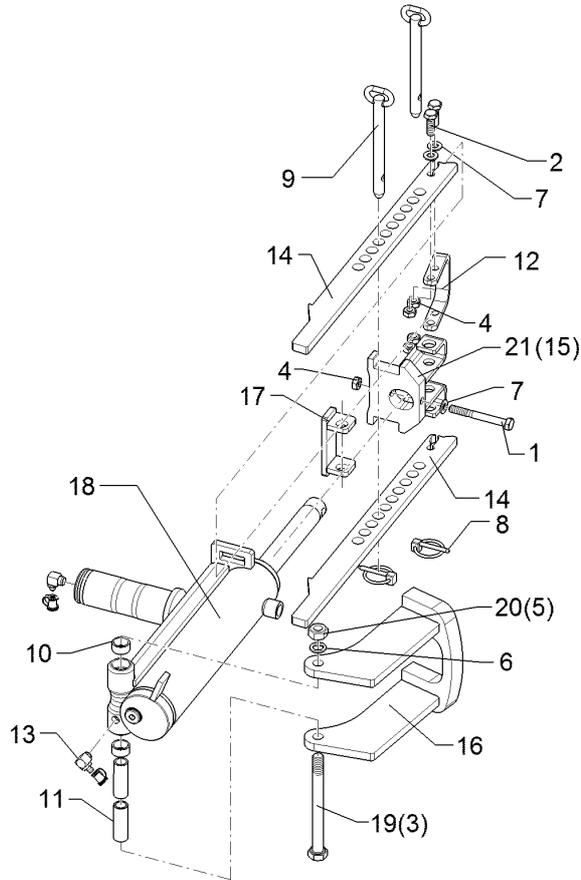

01.18

Pos.	Art.Nr.	Stck.	Artikeltext / Description		Abmessung
20	303 0934	1	Sicherungsmutter	Selflocking nut	NM12-8 Zn DIN985
21	44910028	1	Gabelstück	Forkpiece	D26/35 92X77

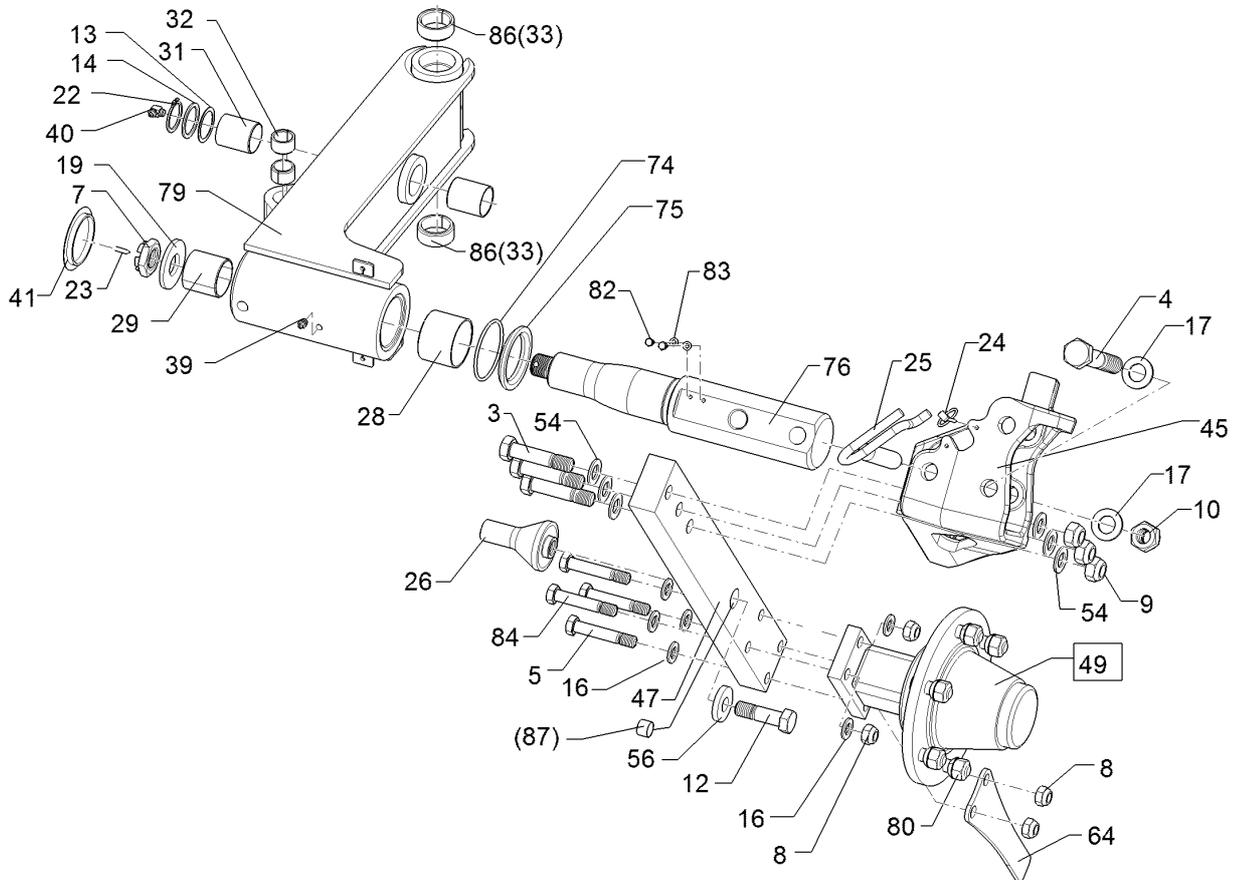

01.18

Pos.	Art.Nr.	Stck.	Artikeltext / Description		Abmessung
3	301 4607	3	Sechskantschraube spz.	Hexagon bolt	M20x90-12.9 Zn
4	301 4700	1	Sechskantschraube	Hexagon bolt	M24x140-8.8 DIN931-A
5	301 3920	2	Sechskantschraube spz.	Hexagon bolt	M16x80ls55xb20-8.8 Zn
7	303 0142	1	Kronenmutter	Castle nut	DIN937-M30x1,5
8	303 0935	4	Sicherungsmutter	Selflocking nut	NM16-8 Zn DIN985
9	303 0936	3	Sicherungsmutter	Selflocking nut	NM20-8 Zn DIN985
10	303 0937	1	Sicherungsmutter	Selflocking nut	NM24-8 Zn DIN985
12	301 5390	1	Sechskantschraube spz.	Hexagon bolt	M20x65-12.9 Zn
13	305 2095	1	Passscheibe	Shim	40x50x1,0 DIN988 Zn
14	305 2250	1	Stützscheibe	Supporting washer	S 40x50x2,5 DIN988 Zn
16	305 6141	8	Scheibe	Washer	17/30x3 DIN/ISO-7089
17	305 6254	2	Scheibe	Washer	D25/44x4 Zn ISO7089
19	305 6425	1	Scheibe	Washer	D70/31x6 Zn
22	305 8875	1	Sicherungsring	Retaining ring	40x2,5 DIN471
23	311 7648	1	Splint	Peg	6,3x50 DIN94-St Zn
24	311 9565	1	Klappstift	Securing pin	4,5
25	313 1816	1	Bolzen mit Griff	Pin with grip	D24x113 Zn
26	31310039	1	Achse	Axle	D70/30x113 M20
28	317 3036	1	Einspannbuchse Kunststoff	Expansion bush	EG65/70x50 GSM
29	317 3037	1	Einspannbuchse Kunststoff	Expansion bush	EG50/55x50 GSM

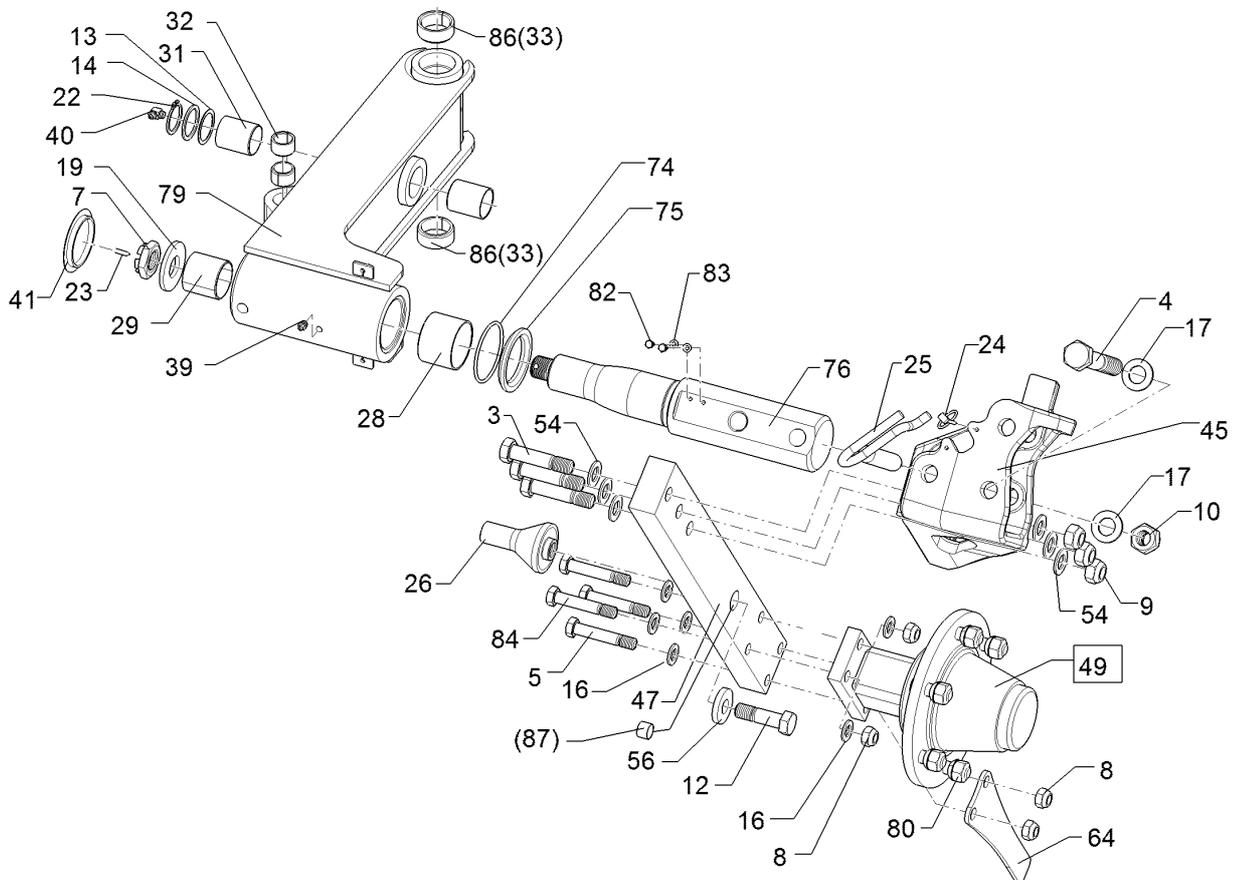

01.18

Pos.	Art.Nr.	Stck.	Artikeltext / Description		Abmessung
31	317 3039	2	Einspannbuchse Kunststoff	Expansion bush	EG40/44x50 GSM
32	317 3413	2	Einspannbuchse	Expansion bush	EG25/32x20 DIN 1498
33	31710183	2	Einspannbuchse	Expansion bush	EG40/50x20 Presssitz
38	323 0530	1	Anlaufscheibe	Thrust washer	68/81x2 SYN
39	323 6348	2	Schmiernippel	Grease nipple	AM10x1 DIN71412
41	323 8054	1	Schutzkappe	Cap	GPN 910/3042 SCHWARZ
45	449 3001	1	Schwenktasche	Bracket	295x288x212 Juwel
47	44910020	1	Radhalm	Wheel stalk	80x35x635
49	549 8904	1	Flanschlager	Flange-type bearing	6/160/205 D18 2xD20
52	305 6012	6	Scheibe	Washer	21 ISO7089 Zn
56	30510175	1	Sperrkantscheibe	Washer	21/40x3 Zn5
64	449 1644	1	Abstreifer	Scraper	8x80x270 2xD17
74	375 1295	1	O-Ring	O-ring	80x4-80Shore Viton83
75	44910005	1	Hülse	Bushing	D90/66x10
76	44910006	1	Achse	Axle	D80/65/50x436-M30x1,5
79	44910014	1	Schwenkarm	Swinging arm	Unirad Juwel 7
80	303 6416	6	Kugelbundmutter	Wheel nut	M18x1,5-10 Zn DIN 74361
82	301 3000	2	Sechskantschraube	Hexagon bolt	M6x10-8.8 Zn DIN933
83	305 8571	2	Scheibe	Washer	6,4 DIN125-A Zn

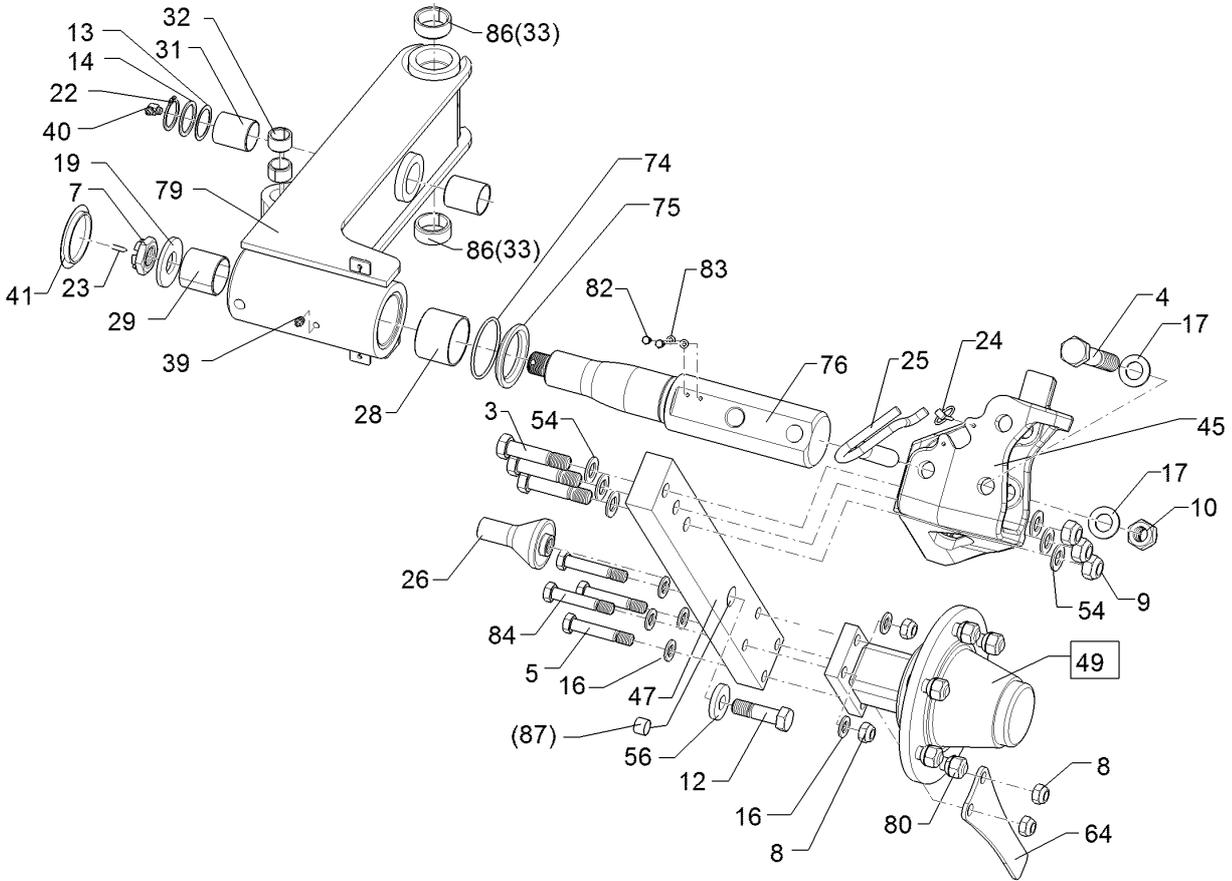

01.18

Pos.	Art.Nr.	Stck.	Artikeltext / Description		Abmessung
84	301 3976	2	Sechskantschraube	Hexagon bolt	M16x90-8.8 Zn DIN931-A
86	31710304	2	Einspannbuchse	Expansion bush	EGPG 50/40x40-CM
87	31710305	1	Einspannbuchse	Expansion bush	EG20/30x25-DIN1498

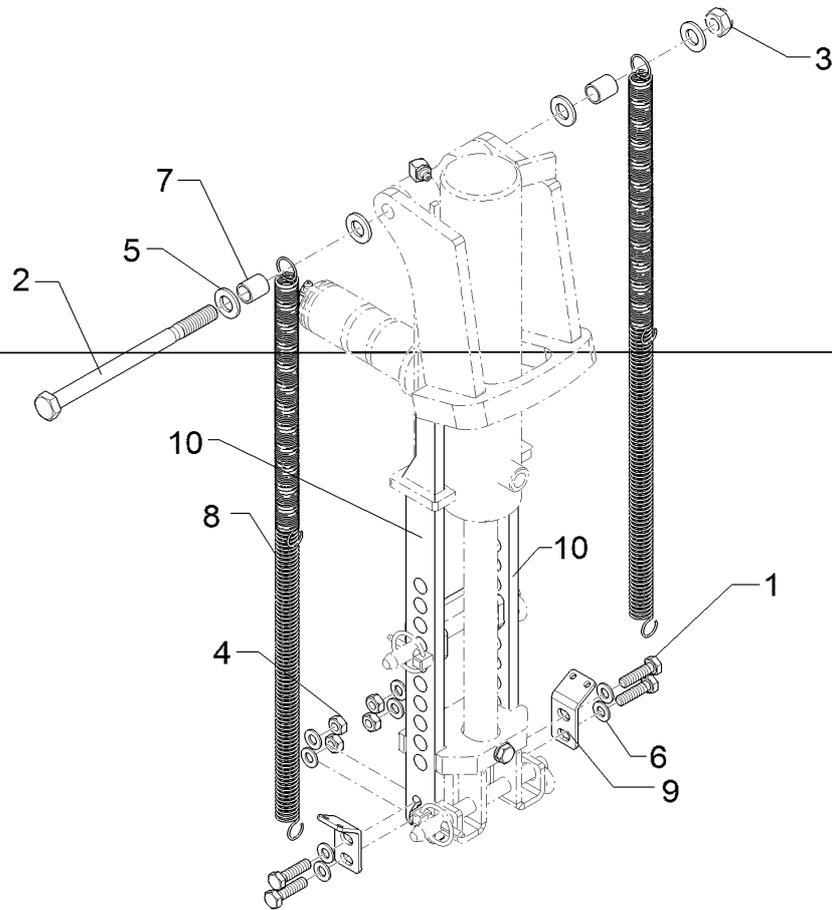

01.18

Pos.	Art.Nr.	Stck.	Artikeltext / Description		Abmessung
1	301 3066	4	Sechskantschraube	Hexagon bolt	M8x30-8.8 Zn DIN933
2	301 3559	1	Sechskantschraube	Hexagon bolt	M12x170-8.8 Zn DIN931-A
3	303 0934	1	Sicherungsmutter	Selflocking nut	NM12-8 Zn DIN985
4	303 1011	4	Sechskantmutter	Hexagon nut	M8 DIN934-8 Zn
5	305 8580	4	Scheibe	Washer	13/24x2,5 St-Zn DIN125
6	305 8694	8	Scheibe	Washer	A8,4 DIN125-St Zn
7	317 6693	2	Röhrchen	Tube	D16/12,5x18 Zn
8	32910032	2	Zugfeder	Spring	Zugfeder
9	44910022	2	Blech	Plate	3x25x62 GEB60°
10	44910029	2	Tiefeneinstellung	Depth adjustment	30x10x367 10xD13

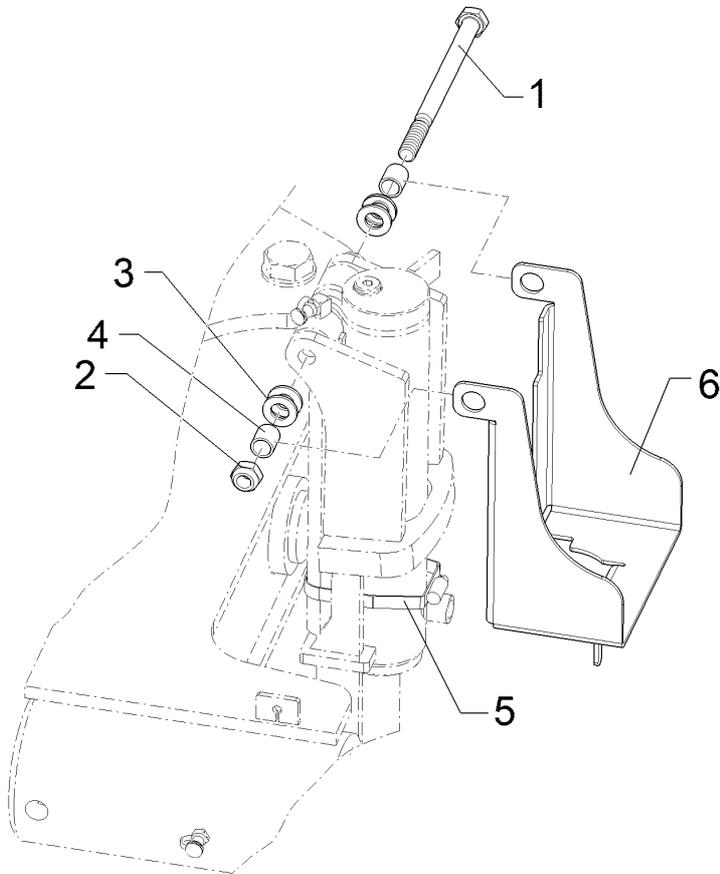

01.18

Pos.	Art.Nr.	Stck.	Artikeltext / Description		Abmessung
1	301 3559	1	Sechskantschraube	Hexagon bolt	M12x170-8.8 Zn DIN931-A
2	303 0934	1	Sicherungsmutter	Selflocking nut	NM12-8 Zn DIN985
3	305 8580	4	Scheibe	Washer	13/24x2,5 St-Zn DIN125
4	317 6693	2	Röhrchen	Tube	D16/12,5x18 Zn
5	325 1166	1	Schlauchschelle	Hose clip	SGT 60/80-12 C7 W4 (V2A)
6	44910025	1	Schutzblech	Guard	3x125,2x546,5 5xGEB

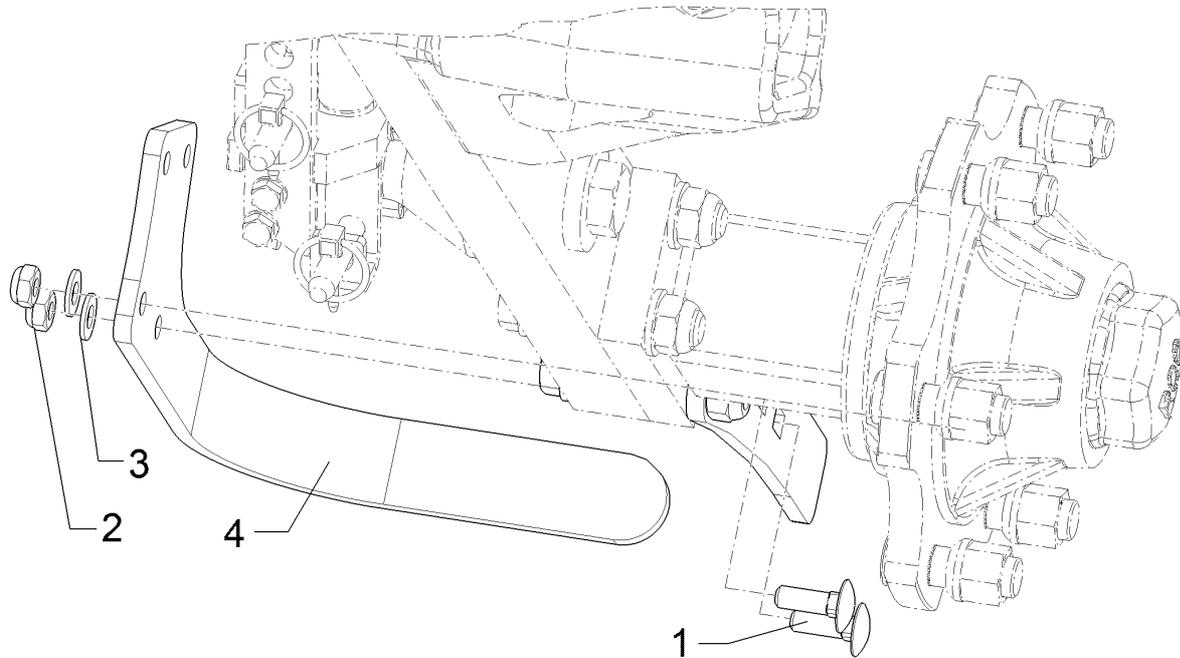

01.18

Pos.	Art.Nr.	Stck.	Artikeltext / Description		Abmessung
1	301 1706	2	Flachrundschraube	Saucer-head screw	M10x30-8.8 Zn DIN603
2	303 0933	2	Sicherungsmutter	Selflocking nut	NM10-8 DIN985 Zn
3	305 8696	2	Scheibe	Washer	A10,5 DIN125-St Zn
4	44910027	1	Abstreifer	Scraper	Unirad GEB 90°

Rad/Wheel	5
-----------	---

Juwel 7M	550 8862
----------	----------

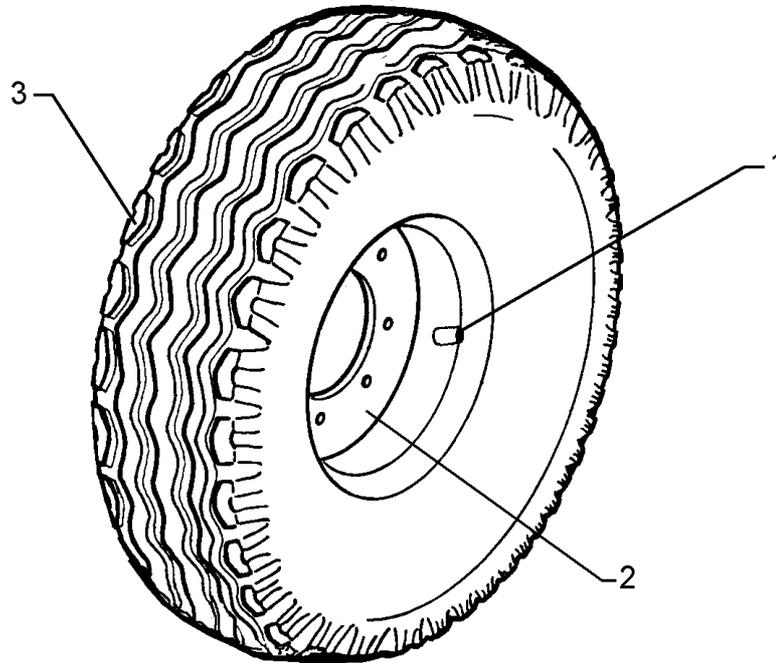

01.18

Pos.	Art.Nr.	Stck.	Artikeltext / Description		Abmessung
1	357 3415	1	Schlauch	Hose	10,0/75-15.3 TR15
2	357 7054	1	Felge	Rim	9.0x15.3 5/94/140 ET-32
3	357 8863	1	Reifen	Tyre	10,0/75-15.3 12PR AW

Rad/Wheel	5
Juwel 7M	550 8863

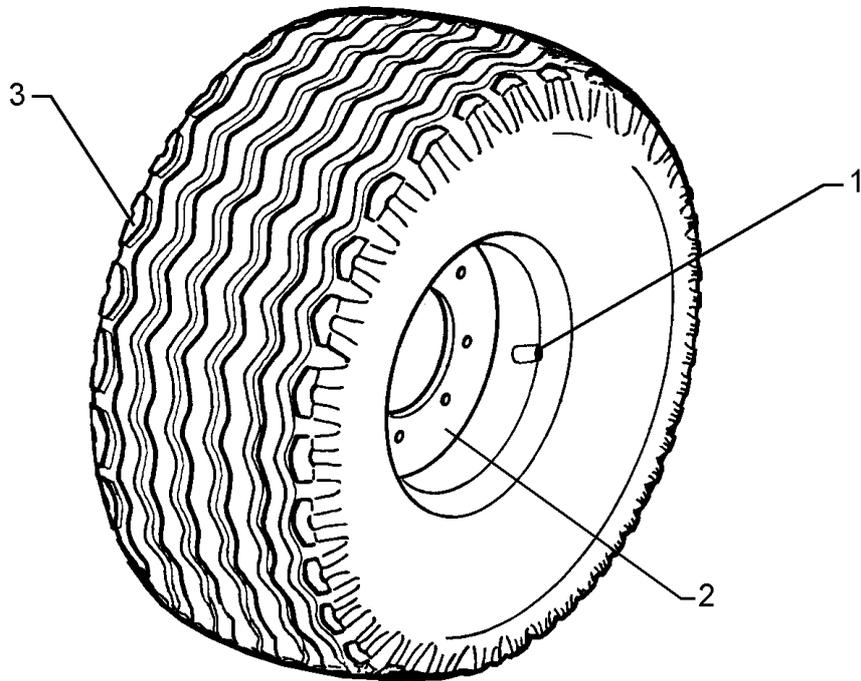

01.18

Pos.	Art.Nr.	Stck.	Artikeltext / Description		Abmessung
1	357 3415	1	Schlauch	Hose	10,0/75-15.3 TR15
2	357 7056	1	Felge	Rim	9.0x15.3 6/161/205 ET-25
3	357 8863	1	Reifen	Tyre	10,0/75-15.3 12PR AW

Rad/Wheel	5
-----------	---

Juwel 7M	550 8864
----------	----------

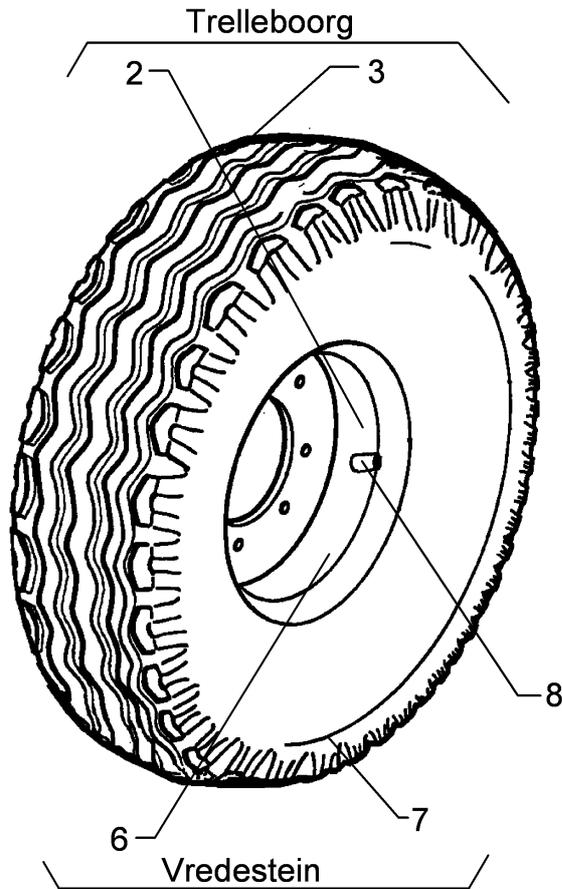

01.18

Pos.	Art.Nr.	Stck.	Artikeltext / Description		Abmessung
2	357 7064	1	Felge	Rim	11.00x16
3	357 8864	1	Reifen	Tyre	6/161/205/B2 ET+40 340/55-16TL AW305 128/140A8
6	357 7031	1	Felge	Rim	11.00x16 6/161/205 ET-50
7	357 8853	1	Reifen	Tyre	350/50-16 12PR Flotation
8	357 2002	1	Ventil	Valve	TR415

Rad/Wheel	5
Juwel 7M	55010332

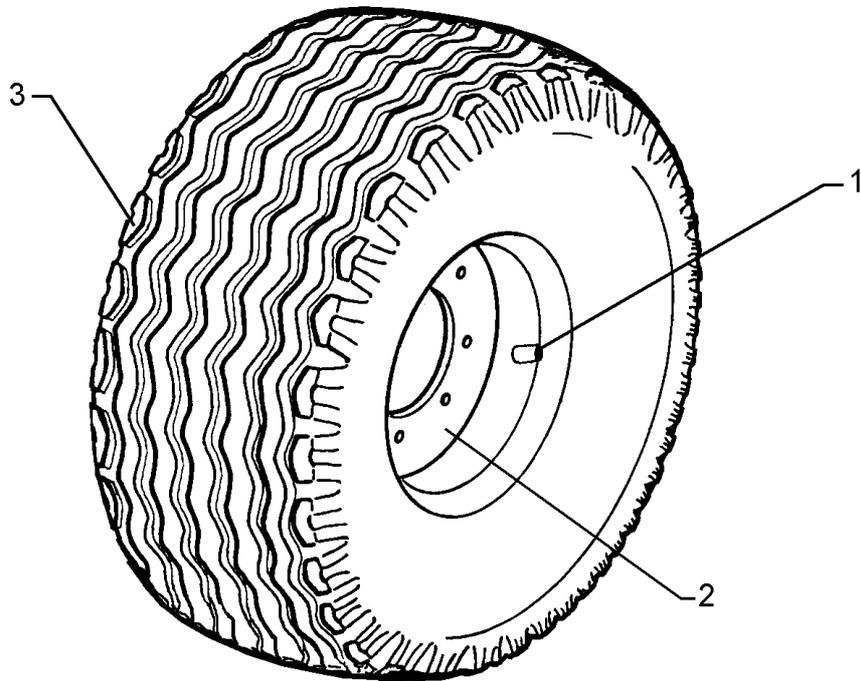

01.18

Pos.	Art.Nr.	Stck.	Artikeltext / Description		Abmessung
2	357 7056	1	Felge	Rim	9.0x15.3 6/161/205 ET-25
3	35710110	1	Reifen	Tyre	10.0/75-15.3 AW702 135A8

Pendelstützrad/Depth wheel	5
Juwel 7M	648 4182

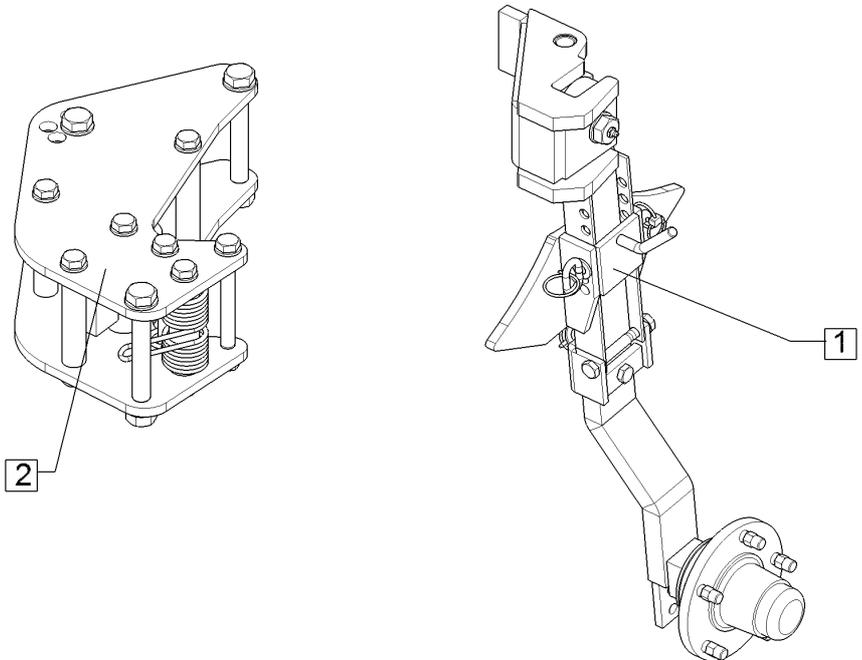

01.18

Pos.	Art.Nr.	Stck.	Artikeltext / Description		Abmessung
1	548 2620	1	Pendelrad-Halm	Wheel stalk	kpl. 5/94/140-L EurOpal 7
2	548 2652	1	Pendelrad-Konsole	Wheel bracket	

Pendelstützrad/Depth wheel	5
Juwel 7M	648 4213

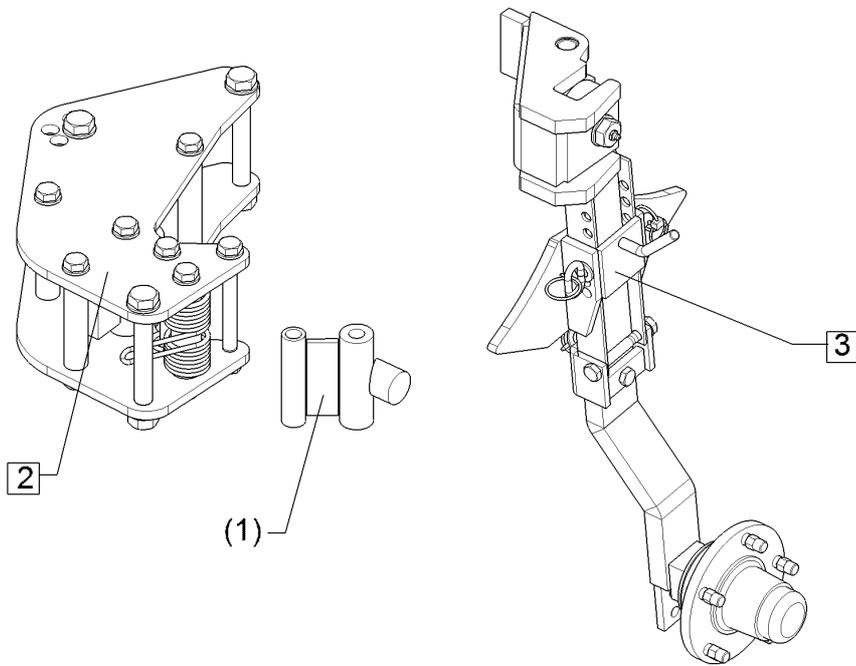

01.18

Pos.	Art.Nr.	Stck.	Artikeltext / Description		Abmessung
1	448 2605	1	Anschlag	Stop	60x30 2xD16x119
2	548 2652	1	Pendelrad-Konsole	Wheel bracket	EurOpal 7
3	548 2621	1	Pendelrad-Halm	Wheel stalk	kpl. 5/94/140 K

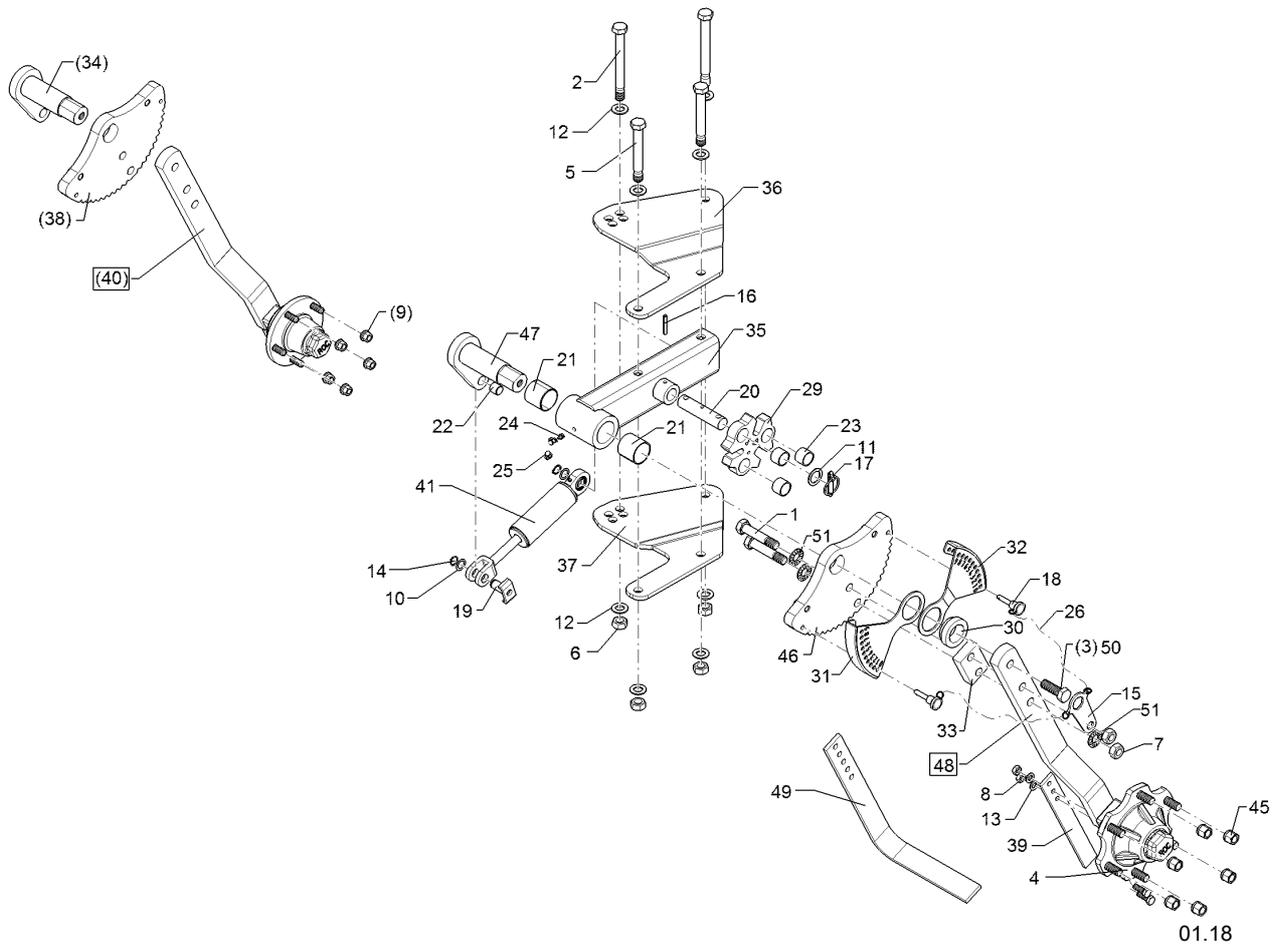

01.18

Pos.	Art.Nr.	Stck.	Artikeltext / Description		Abmessung
1	301 4408	2	Sechskantschraube spz.	Hexagon bolt	M20x100xb25-10.9 Zn
2	301 4523	2	Sechskantschraube spezial	Hexagon bolt	M20x1,5x170ls144xb23-10.9 Zn
3	301 5414	1	Sechskantschraube	Hexagon bolt	M20x60-8.8 Zn DIN933
4	301 7334	2	Sechskantschraube	Hexagon bolt	M12x35-8.8 Zn DIN933
5	30110454	2	Sechskantschraube spezial	Hexagon bolt	M20x1,5x145ls120xb22-10.9 Zn
6	303 0977	4	Sechskantmutter	Hexagon nut	M20x1,5 DIN934-10 Zn
7	30310110	2	Sechskantmutter	Hexagon nut	M20 DIN934-10 Zn
8	303 1013	2	Sechskantmutter	Hexagon nut	M12 DIN934-8 Zn
9	303 6413	5	Kugelbundmutter	Wheel nut	M14x1,5-8 Zn DIN74361
10	305 2228	2	Stützscheibe	Supporting washer	S 20x28x1,0 DIN988 Zn
11	305 2242	1	Stützscheibe	Supporting washer	S 30/42x2,5 DIN988 Zn
12	305 6012	8	Scheibe	Washer	21 ISO7089 Zn
13	305 8580	2	Scheibe	Washer	13/24x2,5 St-Zn DIN125
14	305 8823	2	Sicherungsring	Retaining ring	A20x1,2 Zn DIN471
15	30510157	1	Verdrehsicherung	Locking	5x74x133,5 SW30 D20,1 Zn
16	309 7000	1	Spannhülse	Expansion bush	8x50-DIN1481 Zn
17	31110012	1	Sicherheitsklappstecker	Securing pin	12x45+ Zn

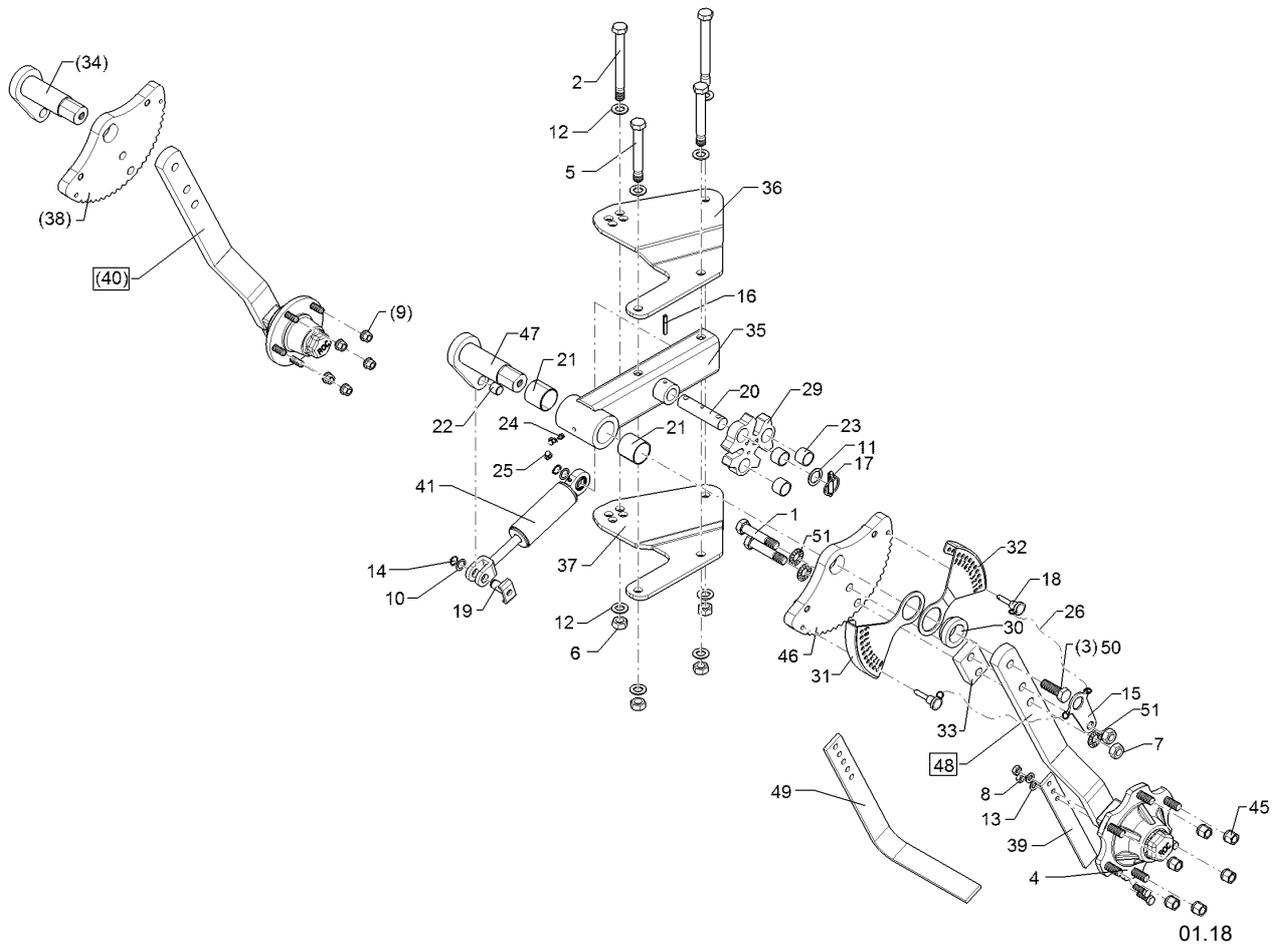

01.18

Pos.	Art.Nr.	Stck.	Artikeltext / Description		Abmessung
18	31310103	2	Steckbolzen	Socket pin	D10x35 Zn
19	31310104	1	Bolzen	Pin	D20x42/46 U42 Zn
20	31310106	1	Bolzen	Pin	D30x130 2xD12 1xD8
21	317 3037	2	Einspannbuchse Kunststoff	Expansion bush	EG50/55x50 GSM
22	31710145	1	Gleitlager	Sleeve bearing	QSM-2023-20
23	31710146	3	Gleitlager	Sleeve bearing	TX1SM-3035-25
24	323 6348	1	Schmiernippel	Grease nipple	AM10x1 DIN71412
25	323 6401	3	Schutzkappe	Cap	M6-M10
26	331 6131	2	Knotenkette	Knotted-link chain	D2x100
29	44810018	1	Sperrhaken	Ratchet	101,5/94,9/87,3
30	44810019	1	Distanzring	Distance ring	D70x45,1x25
31	44810020	1	Tiefeneinstellung	Depth adjustment	4x183x215 D60,1 RE
32	44810021	1	Tiefeneinstellung	Depth adjustment	4x182x215 GEK5 D60,1 LI
33	44810022	1	Distanzplatte	Distance plate	60x25x90 2xD20,1-60
34	44810024	1	Welle	Shaft	D50x186
35	44810027	1	Radlenker	Link	Pendelrad Juwel 7/8
36	44810030	1	Lagerplatte	Bearing plate	10x371,6x399,2 GEK10 RE
37	44810031	1	Lagerplatte	Bearing plate	10x371,6x399,2 GEK10 LI
38	44810032	1	Rasterblech	Raster plate	25x213,25x340
39	449 1642	1	Abstreifer	Scraper	40x8x330 3xD12

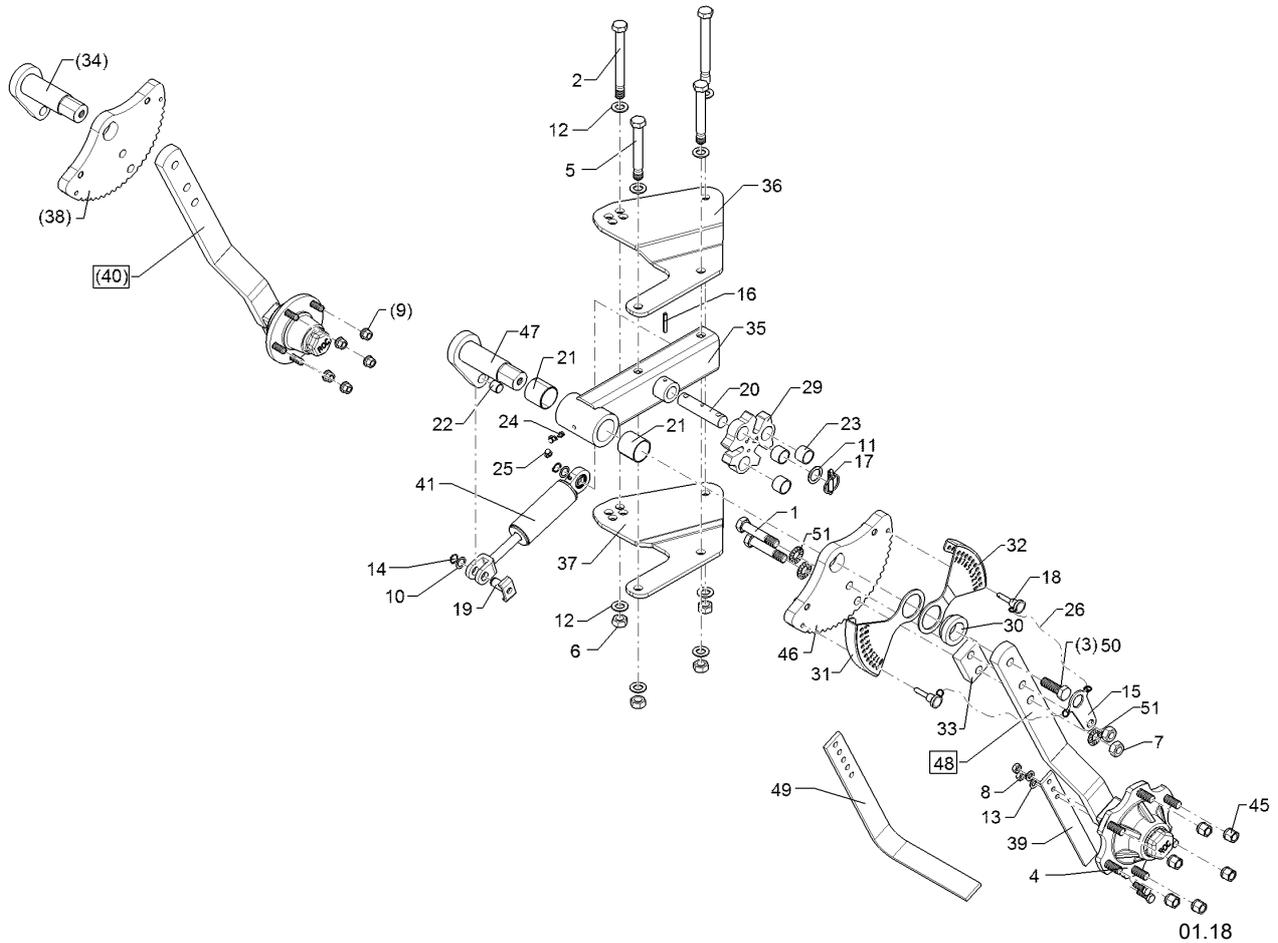

Pos.	Art.Nr.	Stck.	Artikeltext / Description		Abmessung
40	54810008	1	Radhalm mit Lagerung	Wheel stalk with bearing	60x25x553
41	57510679	1	Dämpferzylinder	Ram	50/20x250/95 D20
45	303 6416	6	Kugelbundmutter	Wheel nut	M18x1,5-10 Zn DIN 74361
46	44810033	1	Rasterblech	Raster plate	25x213,25x340
47	44810034	1	Welle	Shaft	D50x186
48	54810020	1	Radhalm	Wheel stalk	60x25x553 6-Loch
49	449 1643	1	Abstreifer	Scraprer	50x10x400 5xD13 GEB90°
50	301 4251	1	Sechskantschraube	Hexagon bolt	M20x55-10.9
51	30510175	3	Sperrkantscheibe	Washer	DIN933 21/40x3 Zn5

Uni-Rad/Uni-wheel	5
Juwel 7M	64910001

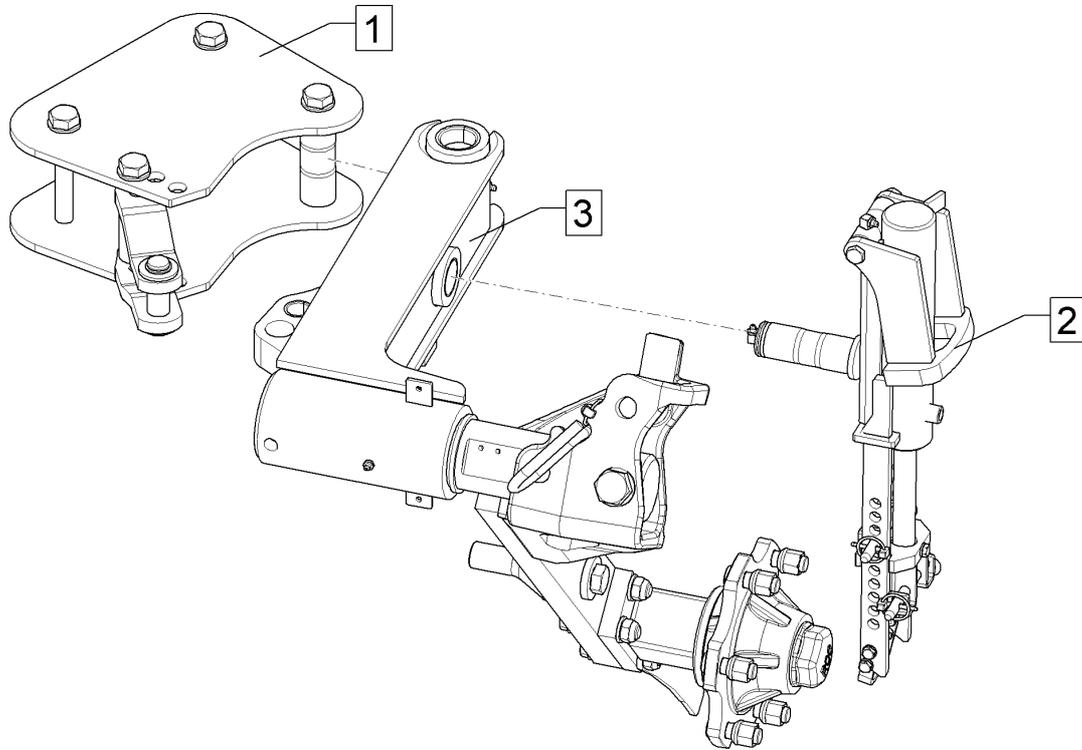

01.18

Pos.	Art.Nr.	Stck.	Artikeltext / Description		Abmessung
1	54910005	1	Radkonsole	Wheel bracket	Unirad J7(M)
2	54910006	1	Dämpferzylinder	Ram	Juwel D50/25x210
3	54910007	1	Radhalm	Wheel stalk	Juwel 7 Uni-Rad Däm. 6/161/205

Uni-Rad/Uni-wheel	5
-------------------	---

Juwel 7M	64910003
----------	----------

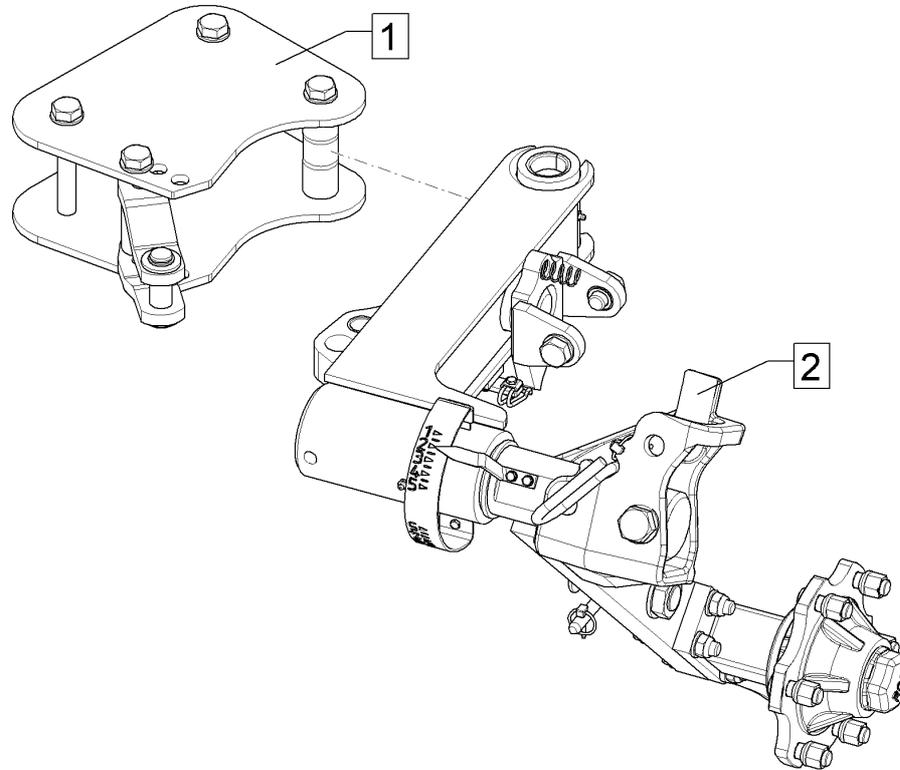

01.18

Pos.	Art.Nr.	Stck.	Artikeltext / Description		Abmessung
1	54910005	1	Radkonsole	Wheel bracket	Unirad J7(M) Juwel 7 Uni-Rad hydr.
2	54910004	1	Radhalm	Wheel stalk	

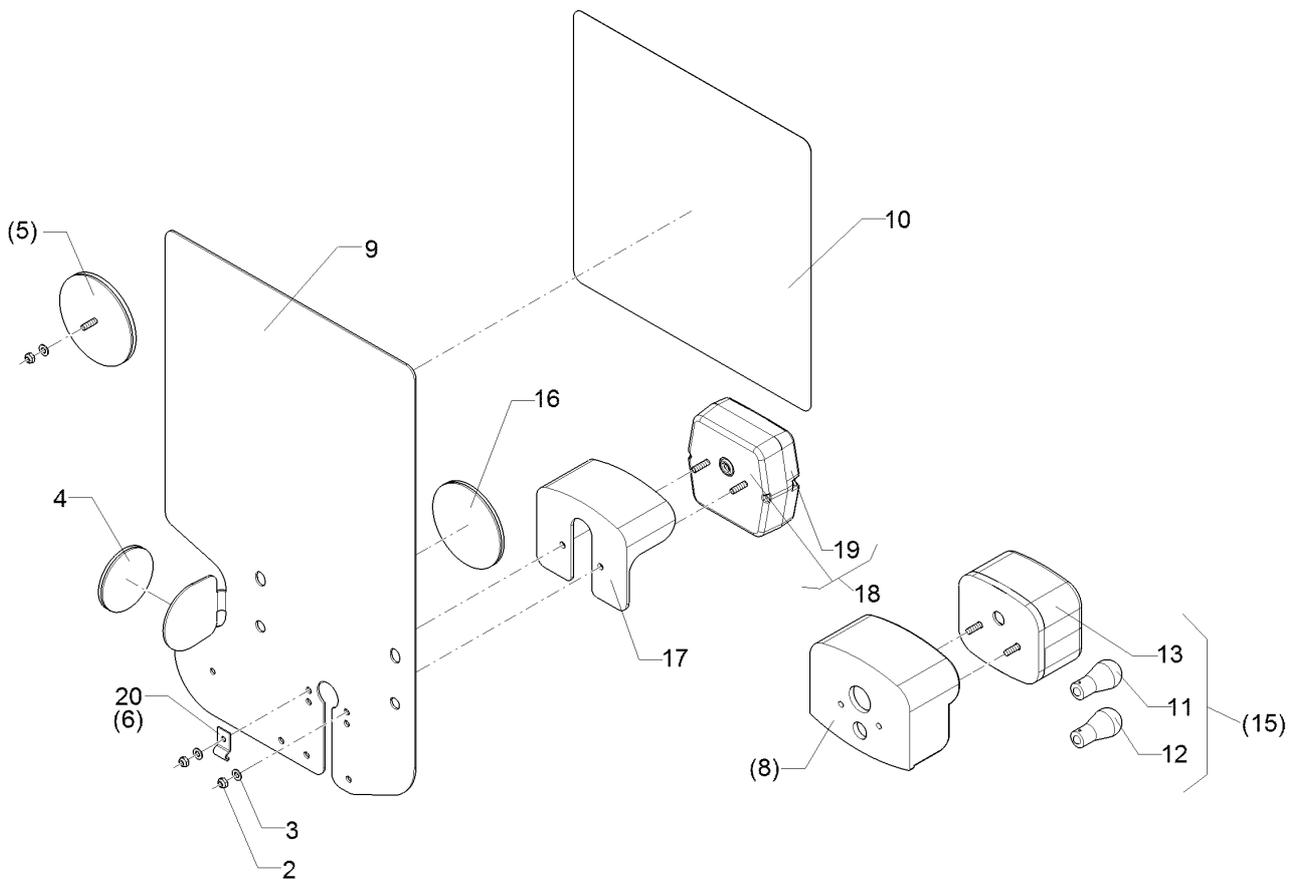

01.18

Pos.	Art.Nr.	Stck.	Artikeltext / Description		Abmessung
2	303 0929	2	Sicherungsmutter	Selflocking nut	NM5-8 Zn DIN985
3	305 8569	2	Scheibe	Washer	5,3 DIN125 Zn
4	321 9919	1	Rückstrahler gelb selbstkl.	Self-adh. reflector, yellow	6200GK
5	321 9922	1	Rückstrahler rot	Reflector, red	8 RA 002 016-111
6	325 5142	1	Schelle	Clamp	96/8
8	373 3801	1	Schutzhaube hinten	Rear cover	SH95
9	470 1766	1	Grundplatte	Basic plate	2x296x478 RE Rd. Zn
10	321 9912	1	Warntafel-Klebefolie	Bonding sheet-warning board	282x282 TP-ESC-B
11	373 1101	1	Kugelbirnen	Lamp	08225 RE 12V 10W Heavy Duty
12	373 1102	2	Kugelbirnen	Lamp	12V 21W Heavy Duty
13	373 3526	1	Lichtscheibe	Light glas	RE E95
15	373 3140	1	Rückleuchte	Rear light	95RGE0,1HD
16	321 9918	1	Rückstrahler rot selbstkl.	Self-adh. reflector, red	8200K
17	373 3802	1	Schutzhaube	Cover	VO SH86
18	37310126	1	Rückleuchte	Rear light	Bl.Br.S. ML
19	37310123	1	Lichtscheibe	Light glas	BBS/BBSK
20	373 1157	1	Kabelschelle	Cable clip	6mm

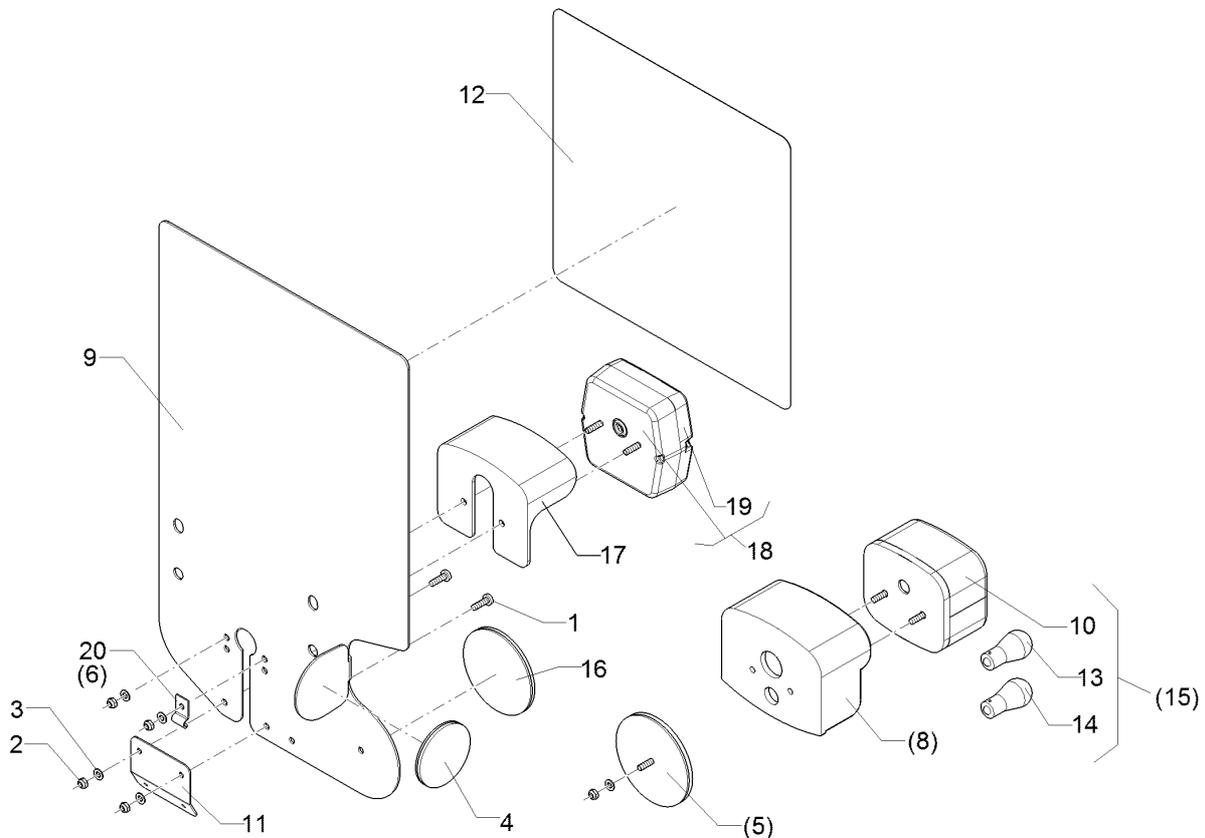

01.18

Pos.	Art.Nr.	Stck.	Artikeltext / Description		Abmessung
1	30110003	2	Linsenschraube	Oval head screw	M5x16-4,6 Zn DIN7985
2	303 0929	4	Sicherungsmutter	Selflocking nut	NM5-8 Zn DIN985
3	305 8569	4	Scheibe	Washer	5,3 DIN125 Zn
4	321 9919	1	Rückstrahler gelb selbstkl.	Self-adh. reflector, yellow	6200GK
5	321 9922	1	Rückstrahler rot	Reflector, red	8 RA 002 016-111
6	325 5142	1	Schelle	Clamp	96/8
8	373 3801	1	Schutzhaube hinten	Rear cover	SH95
9	470 1767	1	Grundplatte	Basic plate	2x296x478 LI Rd. Zn
10	373 3527	1	Lichtscheibe	Light glas	LI EK95
11	321 9987	1	Kennzeichenhalter	Holder for registration plate	1,5x58,9x70 GEB28° Zn
12	321 9913	1	Warntafel-Klebefolie	Bonding sheet-warning board	282x282 TP-ESC-B 08225 LI
13	373 1101	1	Kugelbirnen	Lamp	12V 10W Heavy Duty
14	373 1102	2	Kugelbirnen	Lamp	12V 21W Heavy Duty
15	373 3141	1	Rückleuchte	Rear light	95KLGE0,1HD
16	321 9918	1	Rückstrahler rot selbstkl.	Self-adh. reflector, red	8200K
17	373 3802	1	Schutzhaube	Cover	VO SH86
18	37310127	1	Rückleuchte	Rear light	Bl.Br.S.K. ML
19	37310123	1	Lichtscheibe	Light glas	BBS/BBSK
20	373 1157	1	Kabelschelle	Cable clip	6mm

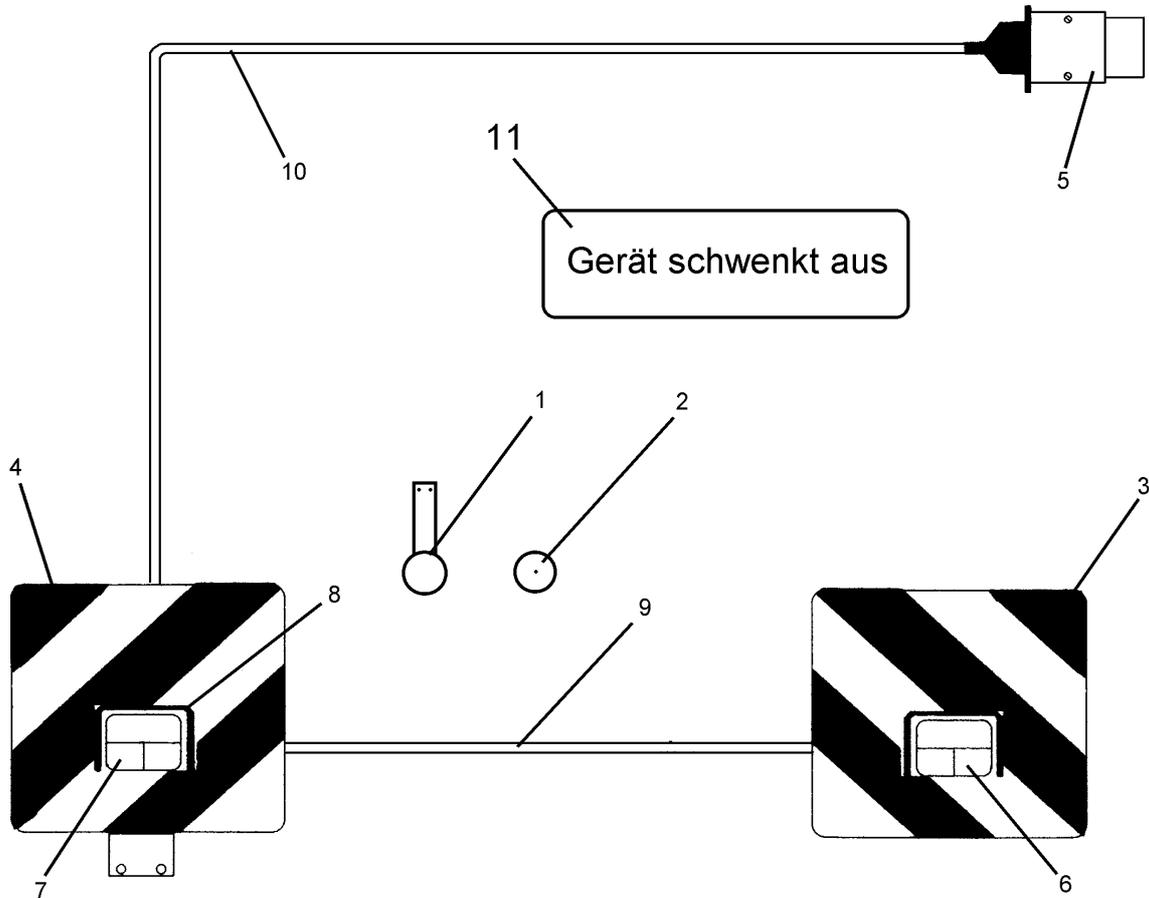

01.18

Pos.	Art.Nr.	Stck.	Artikeltext / Description		Abmessung
1	321 9915	2	Rückstrahler rot m.Pendelhalt.	Reflector, red	D60-55x300
2	321 9916	2	Rückstrahler gelb	Reflector, yellow	D60
3	321 9934	1	Warntafel	Warning board	RE 423x423 DIN11030
4	321 9935	1	Warntafel	Warning board	LI 423x423 DIN11030
5	373 2121	1	Stecker	Plug	7-polig
6	373 3130	1	Rückleuchte	Rear light	BBS95R RE
7	373 3131	1	Rückleuchte	Rear light	BBSK95L LI
8	373 3801	2	Schutzhaube hinten	Rear cover	SH95
9	373 4137	2	Kabel grün	Cable, green	4x0,75
10	373 4140	7	Kabel	Cable	6x0,75 S/W
11	390 6192	1	Aufkleber	Label	Achtung Geraet schwenkt aus

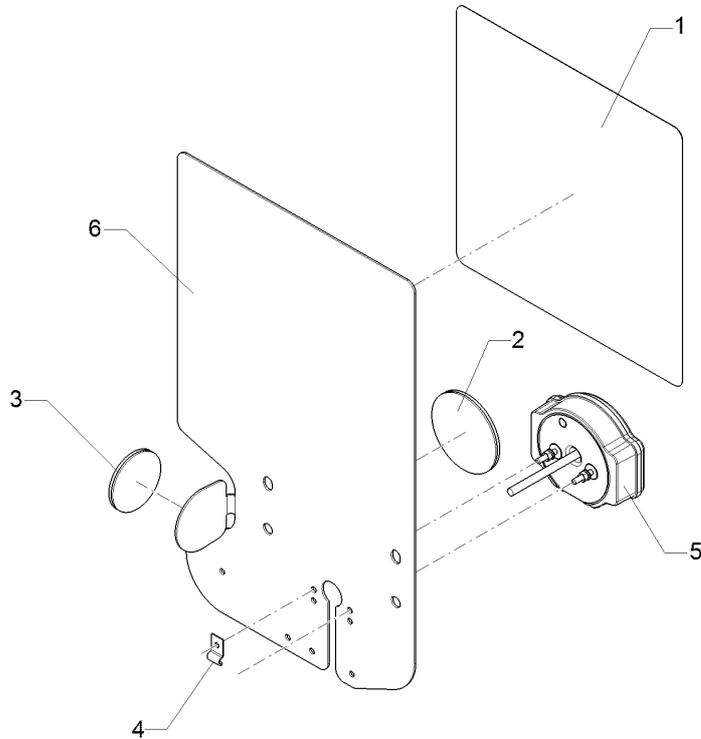

01.18

Pos.	Art.Nr.	Stck.	Artikeltext / Description	Abmessung	
1	321 9912	1	Warntafel-Klebefolie	Bonding sheet-warning board	282x282 TP-ESC-B 08225 RE
2	321 9918	1	Rückstrahler rot selbstkl.	Self-adh. reflector, red	8200K
3	321 9919	1	Rückstrahler gelb selbstkl.	Self-adh. reflector, yellow	6200GK
4	373 1157	1	Kabelschelle	Cable clip	6mm
5	37310212	1	Rückleuchte	Rear light	Bl.Br.S LED ML RE
6	470 1766	1	Grundplatte	Basic plate	2x296x478 RE Rd. Zn

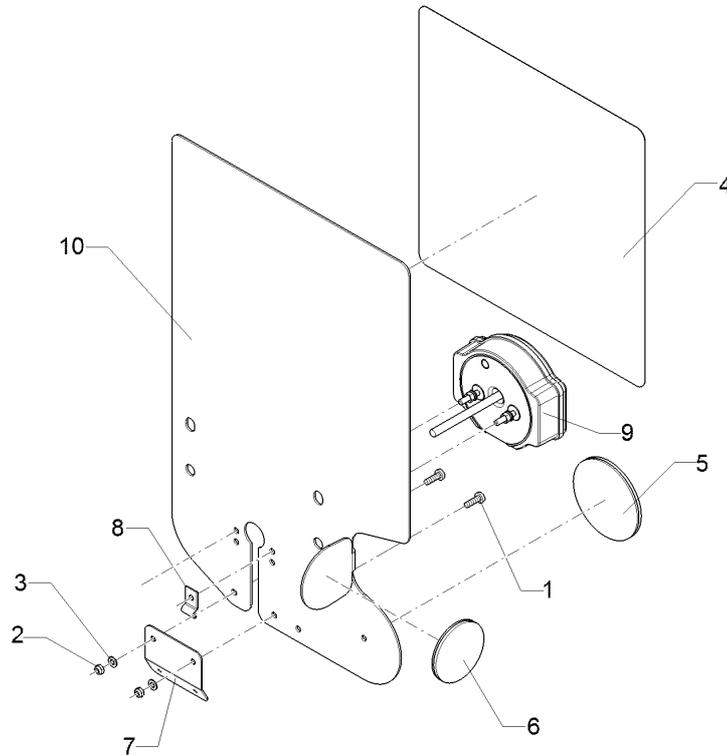

01.18

Pos.	Art.Nr.	Stck.	Artikeltext / Description		Abmessung
1	30110003	2	Linsenschraube	Oval head screw	M5x16-4,6 Zn DIN7985
2	303 0929	2	Sicherungsmutter	Selflocking nut	NM5-8 Zn DIN985
3	305 8569	2	Scheibe	Washer	5,3 DIN125 Zn
4	321 9913	1	Warntafel-Klebefolie	Bonding sheet-warning board	282x282 TP-ESC-B 08225 LI
5	321 9918	1	Rückstrahler rot selbstkl.	Self-adh. reflector, red	8200K
6	321 9919	1	Rückstrahler gelb selbstkl.	Self-adh. reflector, yellow	6200GK
7	321 9987	1	Kennzeichenhalter	Holder for registration plate	1,5x58,9x70 GEB28° Zn
8	373 1157	1	Kabelschelle	Cable clip	6mm
9	37310213	1	Rückleuchte	Rear light	Bl.Br.S.K LED ML LI
10	470 1767	1	Grundplatte	Basic plate	2x296x478 LI Rd. Zn

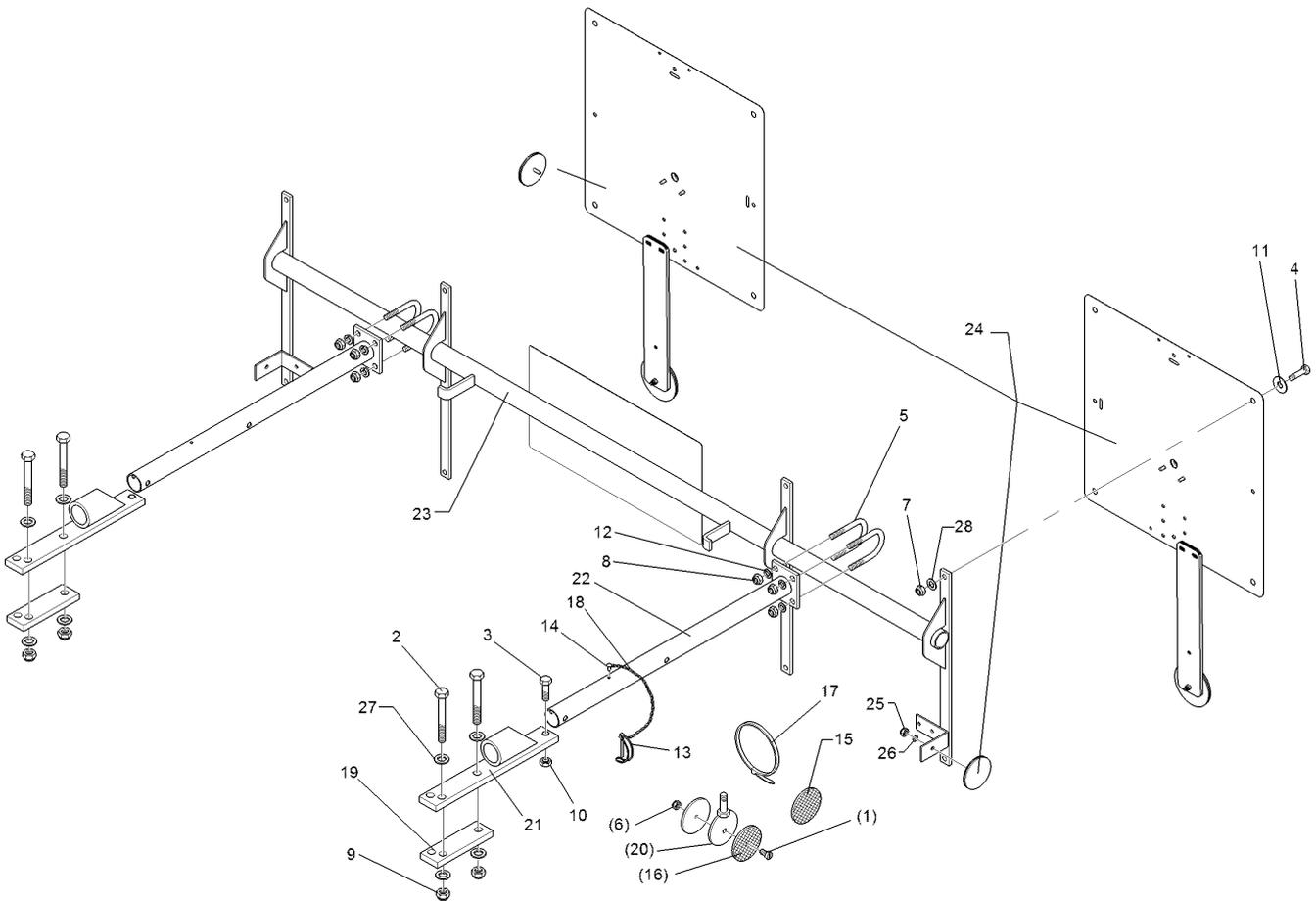

01.18

Pos.	Art.Nr.	Stck.	Artikeltext / Description		Abmessung
1	301 3006	1	Sechskantschraube	Hexagon bolt	M6x25-8.8 Zn DIN933
2	301 3432	4	Sechskantschraube	Hexagon bolt	M12x80-8.8 Zn DIN931-A
3	301 3350	2	Sechskantschraube	Hexagon bolt	M12x50-8.8 Zn DIN933
4	301 6750	8	Sechskantschraube	Hexagon bolt	M8x20-8.8 Zn DIN933
5	301 7781	4	Bügel schraube	U-bolt	M10x48x76 Zn DIN3570A
6	303 0931	1	Sicherungsmutter	Selflocking nut	NM6-8 Zn DIN985
7	303 0932	8	Sicherungsmutter	Selflocking nut	NM8-8 Zn DIN985
8	303 0933	8	Sicherungsmutter	Selflocking nut	NM10-8 DIN985 Zn
9	303 0934	4	Sicherungsmutter	Selflocking nut	NM12-8 Zn DIN985
10	303 1013	2	Sechskantmutter	Hexagon nut	M12 DIN934-8 Zn
11	305 6124	8	Scheibe	Washer	8,4/25x2 DIN9021-St Zn
12	305 8696	8	Scheibe	Washer	A10,5 DIN125-St Zn
13	311 9305	2	Rohrklappstecker	Securing pin	8x50/S9
14	315 9616	2	Blindniet	Rivet	4,8x10
15	321 9919	4	Rückstrahler gelb selbstkl.	Self-adh. reflector, yellow	6200GK
16	321 9921	2	Rückstrahler gelb m. Loch	Reflector, yellow	D60
17	325 1331	8	Kabelbinder	Cable clip	4,7x186
18	331 6130	2	Knotenkette	Knotted-link chain	D2x150
19	459 1071	2	Brücke	Clamp plate	40x12x132 3xD14-92,5-102,5

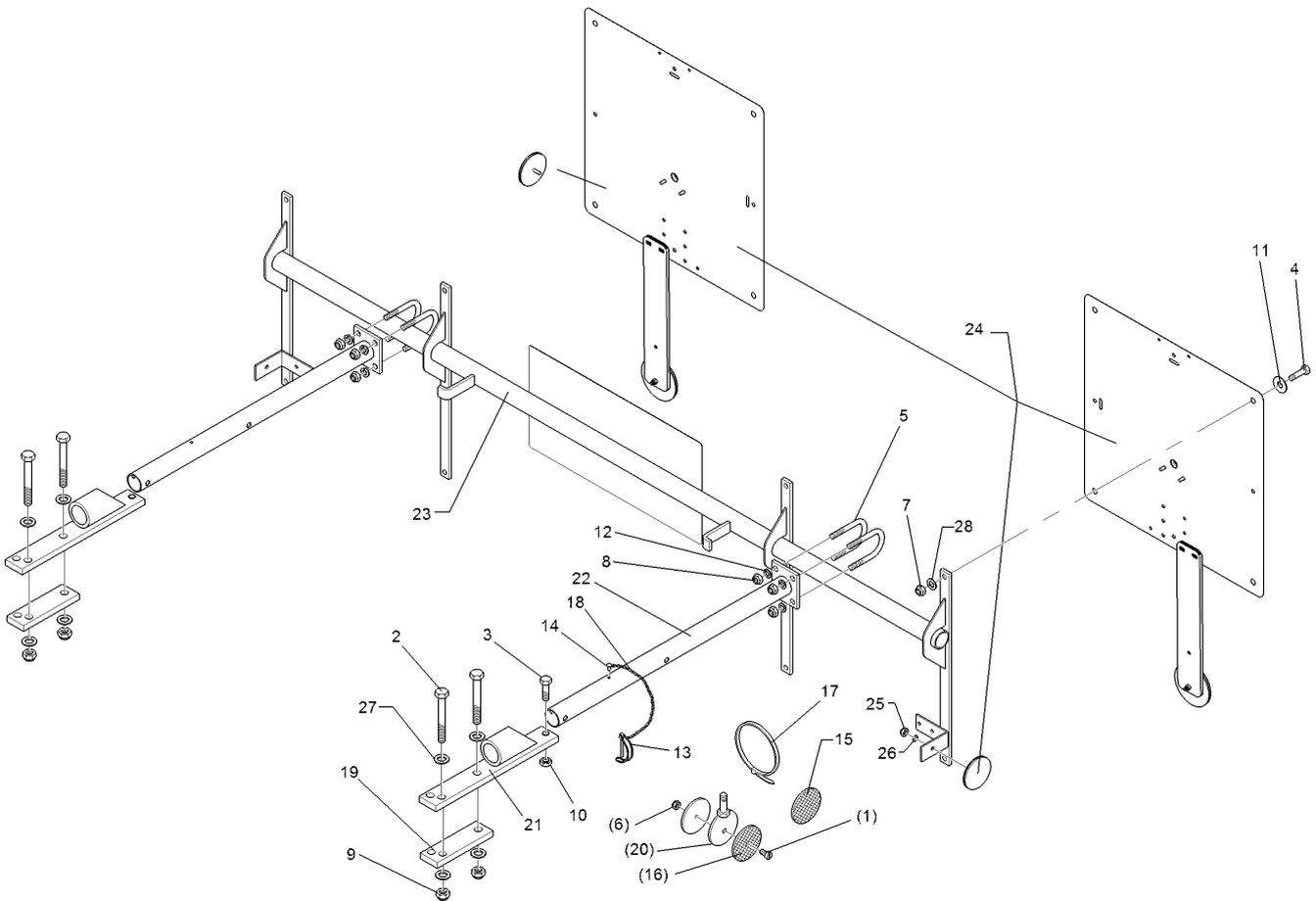

01.18

Pos.	Art.Nr.	Stck.	Artikeltext / Description	Abmessung
20	470 1200	1	Halter	Holder
21	470 1672	2	Halter	Holder
22	470 1673	2	Träger	Carrier
23	470 1674	1	Leuchtenhalter	Lamp holder
24	570 2086	1	Beleuchtungsanlage	Lighting equipment
25	303 0929	2	Sicherungsmutter	Selflocking nut
26	305 8569	2	Scheibe	Washer
27	305 8580	8	Scheibe	Washer
28	305 8694	8	Scheibe	Washer
				D70xD7-M10x25
				40x12x290
				Halm70-80
				60x70x550
				BLA-1 PF/UNI
				33,7x1580
				Pflug
				NM5-8 Zn DIN985
				5,3 DIN125 Zn
				13/24x2,5 St-Zn
				DIN125
				A8,4 DIN125-St Zn

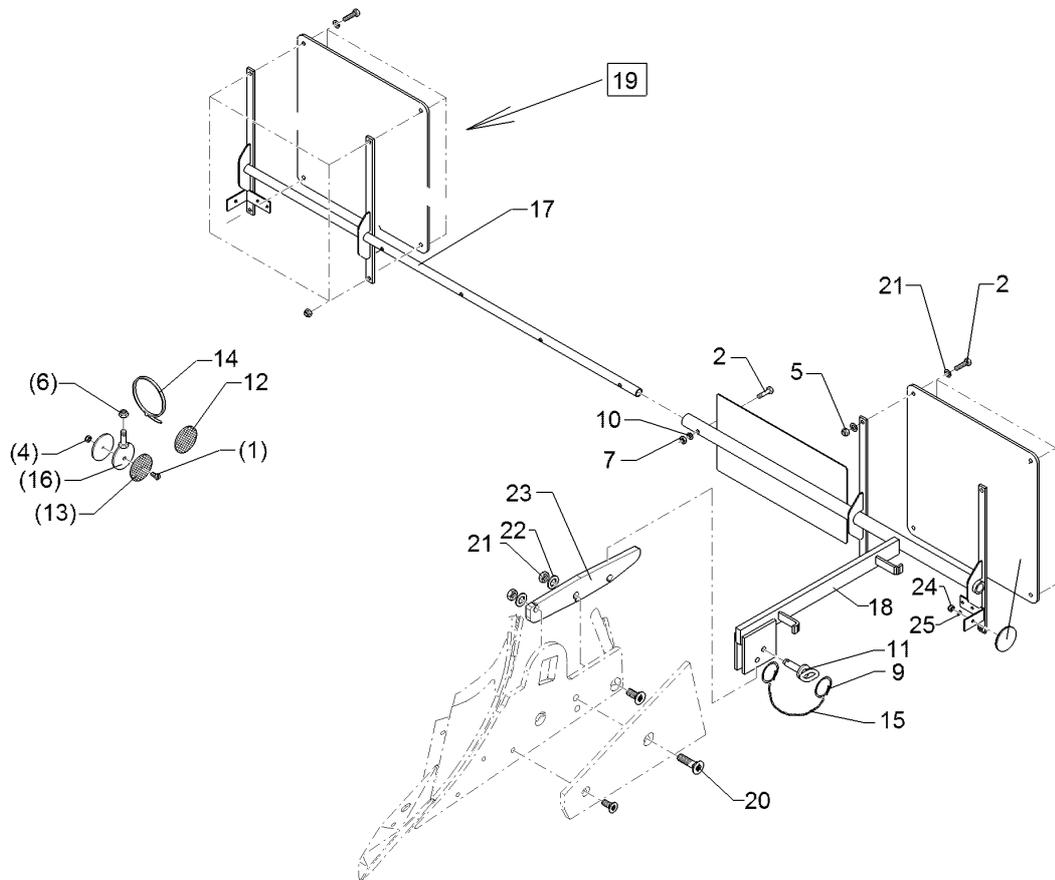

01.18

Pos.	Art.Nr.	Stck.	Artikeltext / Description		Abmessung
1	301 3006	1	Sechskantschraube	Hexagon bolt	M6x25-8.8 Zn DIN933
2	301 3070	1	Sechskantschraube	Hexagon bolt	M8x40-8.8 Zn DIN931-A
3	301 6750	8	Sechskantschraube	Hexagon bolt	M8x20-8.8 Zn DIN933
4	303 0931	1	Sicherungsmutter	Selflocking nut	NM6-8 Zn DIN985
5	303 0932	8	Sicherungsmutter	Selflocking nut	NM8-8 Zn DIN985
6	303 0933	1	Sicherungsmutter	Selflocking nut	NM10-8 DIN985 Zn
7	303 1011	1	Sechskantmutter	Hexagon nut	M8 DIN934-8 Zn
8	305 6124	8	Scheibe	Washer	8,4/25x2 DIN9021-St Zn
9	305 8551	2	Sicherungsring	Retaining ring	Di41x3 A2
10	305 8694	10	Scheibe	Washer	A8,4 DIN125-St Zn
11	313 7807	1	Bolzen	Pin	D12x59/117,5 V Zn
12	321 9919	2	Rückstrahler gelb selbstkl.	Self-adh. reflector, yellow	6200GK
13	321 9921	2	Rückstrahler gelb m. Loch	Reflector, yellow	D60
14	325 1331	5	Kabelbinder	Cable clip	4,7x186
15	331 6130	1	Knotenkette	Knotted-link chain	D2x150
16	470 1200	1	Halter	Holder	D70xD7-M10x25
17	470 1676	1	Halter	Holder	BLA-2 PF RE
18	470 1677	1	Halter	Holder	BLA-2 PF LI
19	570 2086	1	Beleuchtungsanlage	Lighting equipment	Pflug
20	301 6147	1	Senkschraube spz.	Countersunk bolt	M16x60-10.9 4KT Zn
21	303 1015	1	Sechskantmutter	Hexagon nut	M16 DIN934-8 Zn

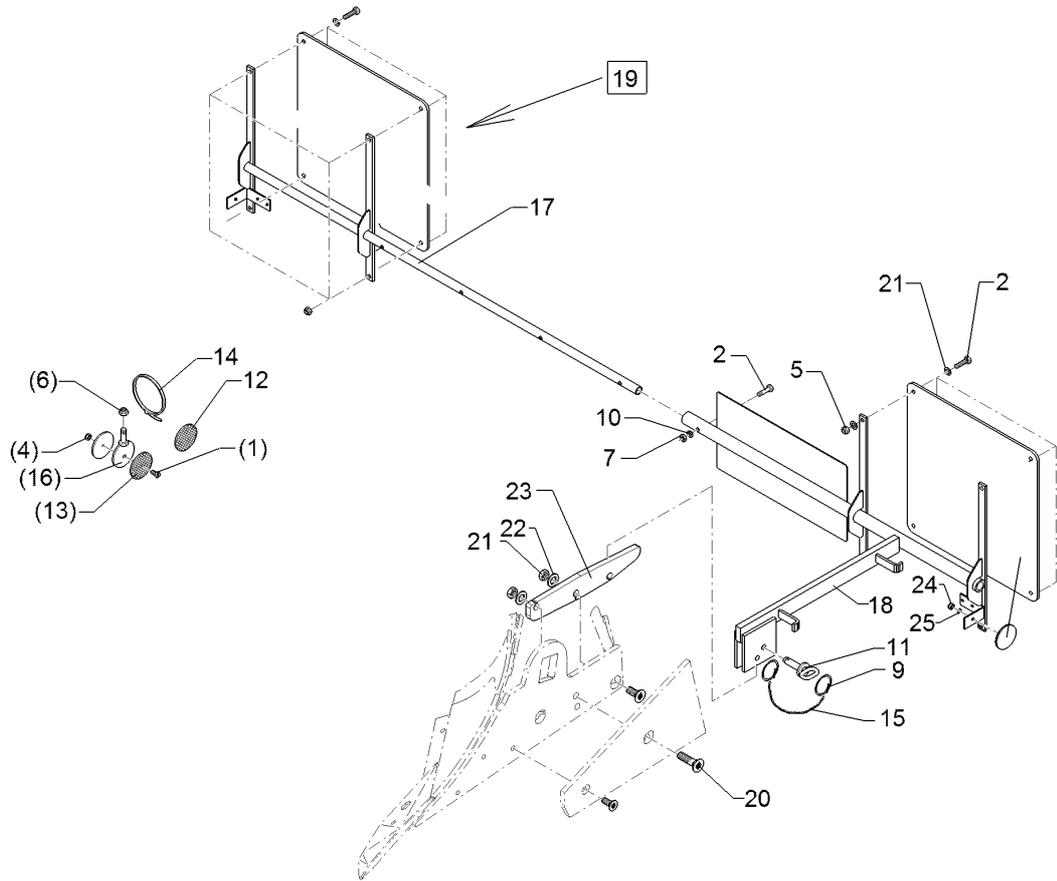

01.18

Pos.	Art.Nr.	Stck.	Artikeltext / Description		Abmessung
22	305 6141	1	Scheibe	Washer	17/30x3 DIN/ISO-7089
23	470 1153	1	Halter	Holder	14x60x348 3xD17
24	303 0929	2	Sicherungsmutter	Selflocking nut	NM5-8 Zn DIN985
25	305 8569	2	Scheibe	Washer	5,3 DIN125 Zn

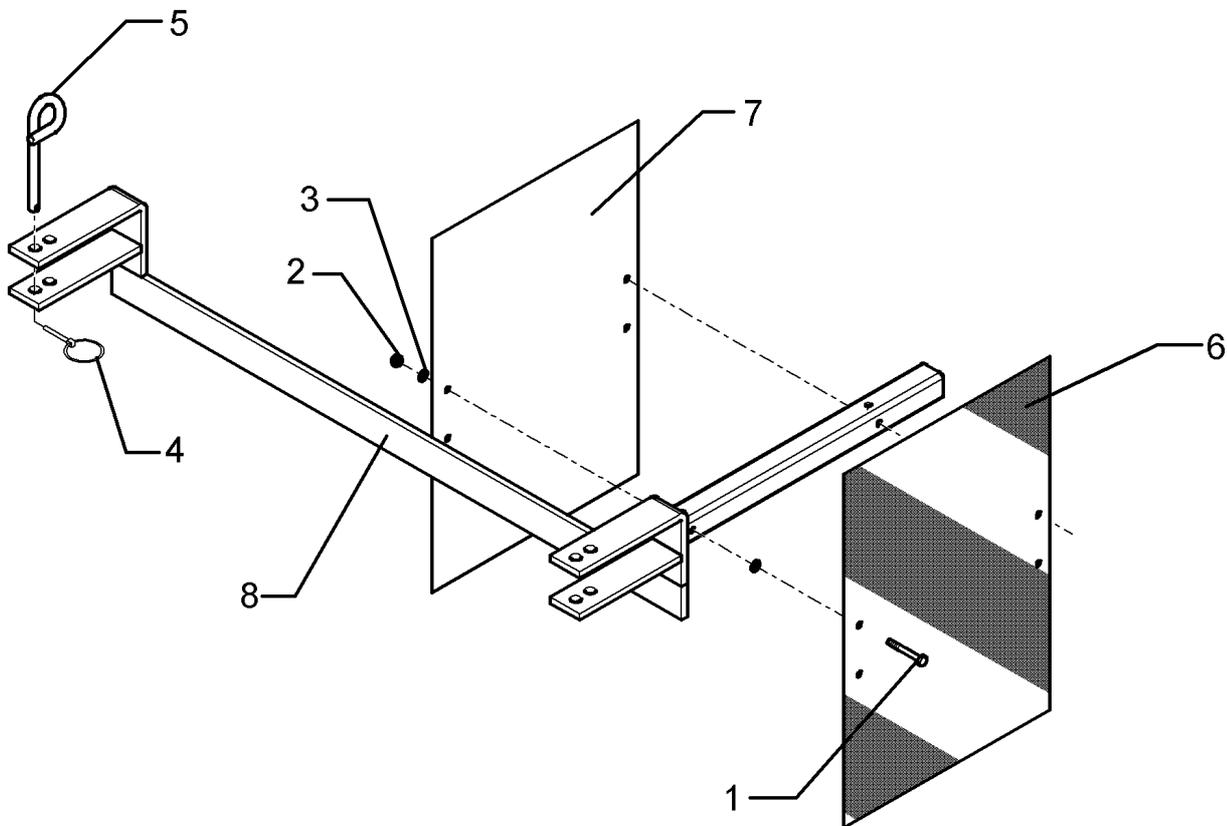

01.18

Pos.	Art.Nr.	Stck.	Artikeltext / Description		Abmessung
1	301 2998	2	Sechskantschraube	Hexagon bolt	M5x40-8.8 Zn DIN931-A
2	303 0967	2	Sechskantmutter	Hexagon nut	M5 DIN934-8 Zn
3	305 6968	4	Scheibe	Washer	R5,5/18x2 DIN440-St Zn
4	311 9565	2	Klappstift	Securing pin	4,5
5	313 8610	2	Bolzen	Pin	D10x85 Zn (10x210)
6	321 9926	1	Warntafel rot/weiss	Warning board red/white	R2 282x423 (B2 TP-ESC-A 06021)
7	321 9927	1	Warntafel rot/weiss	Warning board red/white	R1 423x282 (B1 TP-ESC-A 06021)
8	470 1708	1	Warntafelhalter	Holder	WTH-1

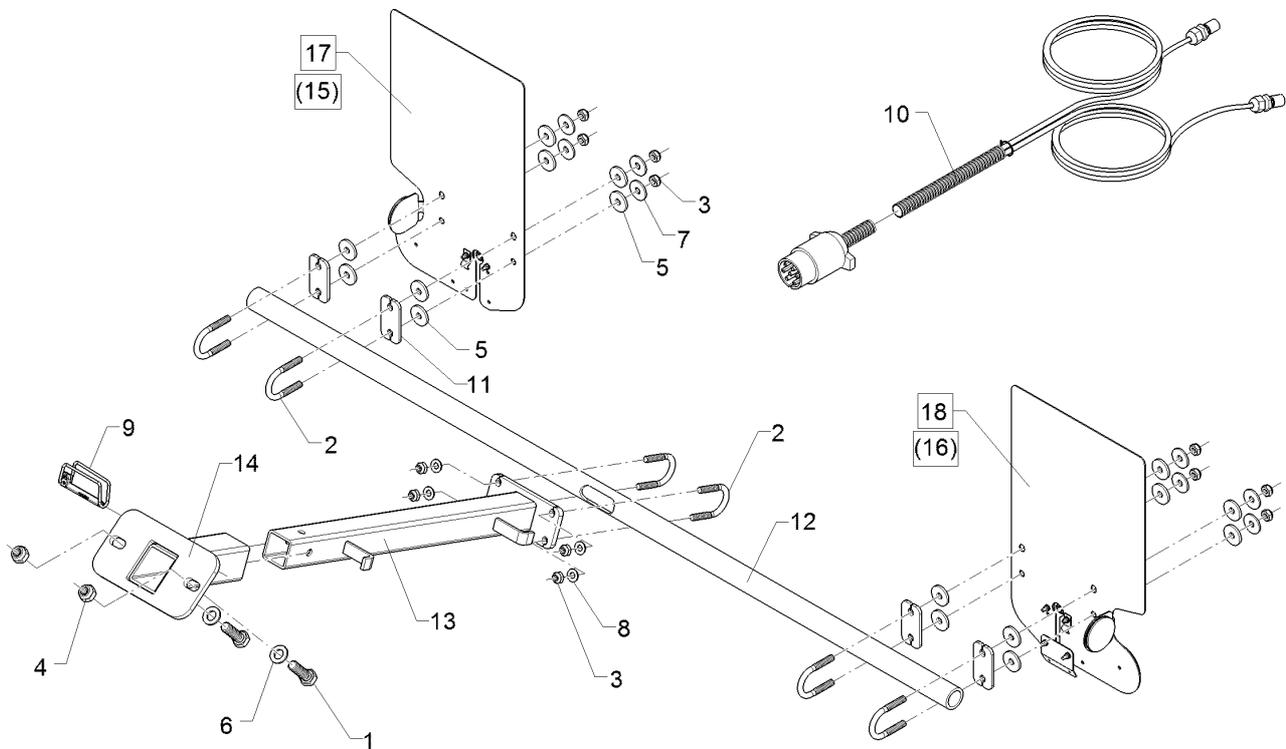

01.18

Pos.	Art.Nr.	Stck.	Artikeltext / Description		Abmessung
1	301 3774	2	Sechskantschraube	Hexagon bolt	M16x50-12.9 A=max.3mm Zn
2	301 7781	6	Bügelsschraube	U-bolt	M10x48x76 Zn DIN3570A
3	303 0933	12	Sicherungsmutter	Selflocking nut	NM10-8 DIN985 Zn
4	30310033	2	Sicherungsmutter	Selflocking nut	NM16 DIN985-10 Zn
5	305 6129	16	Scheibe	Washer	D11/35x4 PU
6	305 6141	2	Scheibe	Washer	17/30x3 DIN/ISO-7089
7	305 6976	8	Scheibe	Washer	R11/34x3 DIN440-St Zn
8	305 8696	4	Scheibe	Washer	A10,5 DIN125-St Zn
9	311 9569	1	Sicherungsstecker	Plug	12x75 Zn
10	37310184	1	Grundkabel	Basic cable	Grk.2x4x0,75x9000 7p.ISO1724
11	470 1776	4	Klemmplatte	Clamping plate	6x40x80 2x11-48/52 Zn
12	47010151	1	Rohr	Tube	D38x5x1560 1xR12,5x75
13	47010152	1	Beleuchtungsträger	Carrier for light	150x70x590
14	47010160	1	Beleuchtungshalter	Carrier for light	Anbaupflug
15	570 1764	1	Beleuchtungseinheit	Lighting unit	2x296x478 Rd. HI RE
16	570 1765	1	Beleuchtungseinheit	Lighting unit	2x296x478 Rd. HI LI
17	57010104	1	Beleuchtungseinheit	Lighting unit	2x296x478 Rd.HI RE
18	57010105	1	Beleuchtungseinheit	Lighting unit	2x296x478 Rd.HI LI

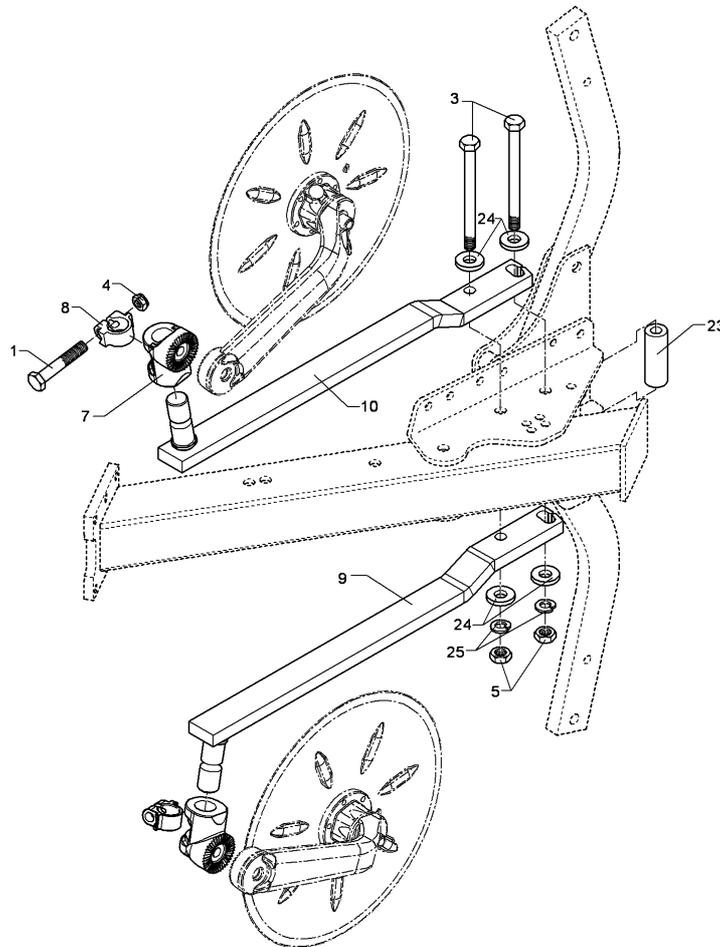

01.18

Pos.	Art.Nr.	Stck.	Artikeltext / Description		Abmessung
1	301 3868	2	Sechskantschraube	Hexagon bolt	M16x65-8.8 Zn
3	301 4545	2	Sechskantschraube spezial	Hexagon bolt	DIN931-A M20x1,5x230ls204xb23-10.9 Zn
4	303 1015	2	Sechskantmutter	Hexagon nut	M16 DIN934-8 Zn
5	303 0977	2	Sechskantmutter	Hexagon nut	M20x1,5 DIN934-10 Zn
7	457 9146	2	Zahnkonsole	Hirth-type bracket	D70/38 Z40
8	457 9870	2	Sperrstück	Stop	D38x29
9	463 8712	1	Maissechhalm	Disc stalk	60x25x832-MHE RE
10	463 8713	1	Maissechhalm	Disc stalk	60x25x832-MHE LI
23	317 7510	1	Distanzbuchse	Distance bush	D40/20,2x120 Zn
24	305 6015	4	Scheibe	Washer	21 DIN7349
25	305 6012	2	Scheibe	Washer	21 ISO7089 Zn

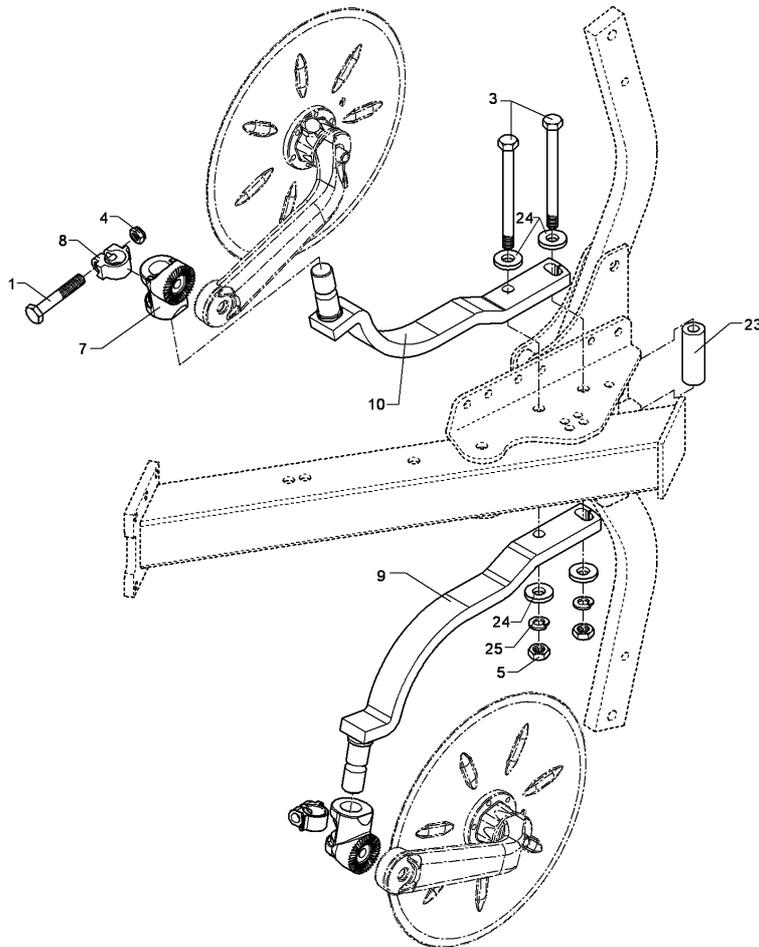

01.18

Pos.	Art.Nr.	Stck.	Artikeltext / Description		Abmessung
1	301 3868	2	Sechskantschraube	Hexagon bolt	M16x65-8.8 Zn
3	301 4545	2	Sechskantschraube spezial	Hexagon bolt	DIN931-A M20x1,5x230ls204xb23-10.9 Zn
4	303 1015	2	Sechskantmutter	Hexagon nut	M16 DIN934-8 Zn
5	303 0977	2	Sechskantmutter	Hexagon nut	M20x1,5 DIN934-10 Zn
7	457 9146	2	Zahnkonsole	Hirth-type bracket	D70/38 Z40
8	457 9870	2	Sperrstück	Stop	D38x29
9	463 8682	1	Sechhalm	Coulter stalk	60x25x630 RE
10	463 8683	1	Sechhalm	Coulter stalk	EurOpal 60x25x630 LI
23	317 7510	1	Distanzbuchse	Distance bush	EurOpal D40/20,2x120 Zn
24	305 6015	4	Scheibe	Washer	21 DIN7349
25	305 6012	2	Scheibe	Washer	21 ISO7089 Zn

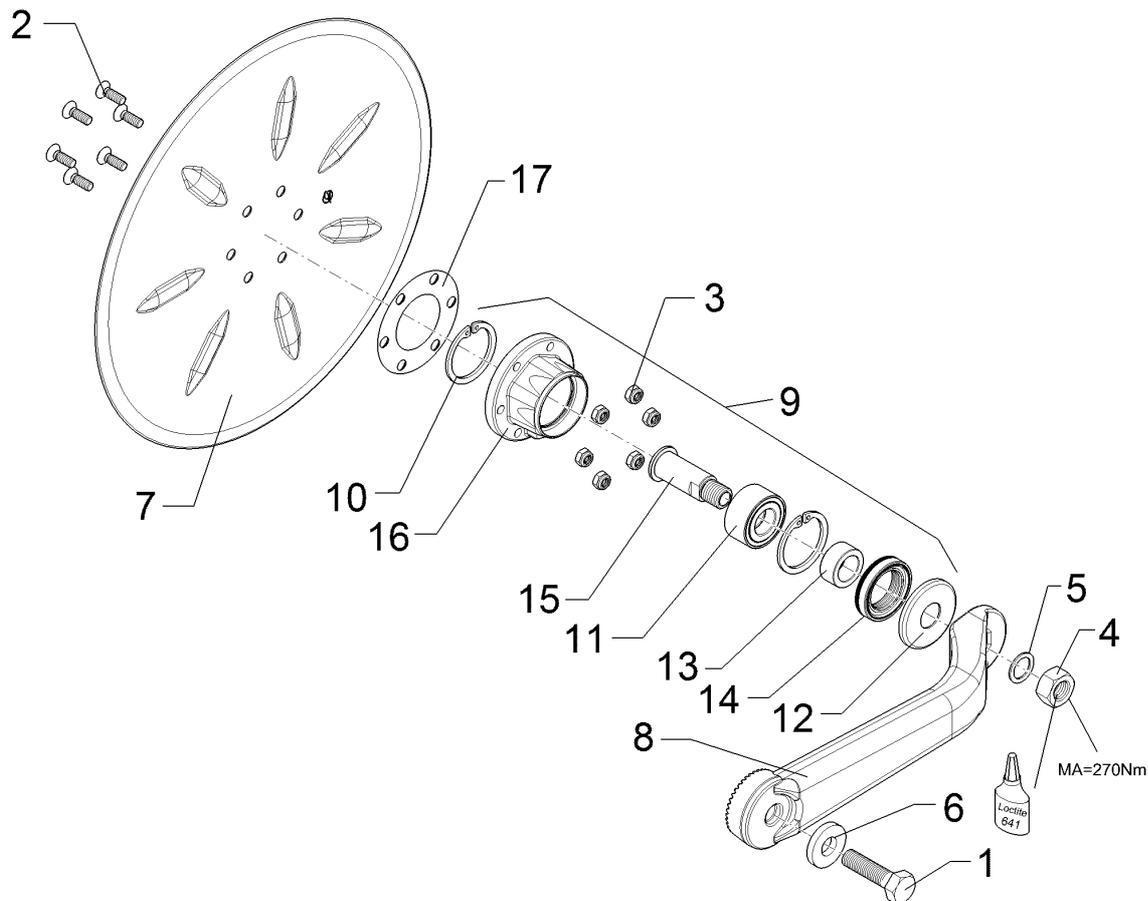

01.18

Pos.	Art.Nr.	Stck.	Artikeltext / Description		Abmessung
1	301 5414	1	Sechskantschraube	Hexagon bolt	M20x60-8.8 Zn DIN933
2	301 6123	6	Senkschraube	Countersunk bolt	M10x30-10.9 Zn DIN7991-A
3	303 0933	6	Sicherungsmutter	Selflocking nut	NM10-8 DIN985 Zn
4	303 0996	1	Sechskantmutter	Hexagon nut	M24x1,5 DIN934-8 Zn
5	305 2230	1	Stützscheibe	Supporting washer	S 25x35x2,0 DIN988 Zn
6	305 6012	1	Scheibe	Washer	21 ISO7089 Zn
7	349 0029	1	Sechscheibe	Disc	D500/100x5 G
8	457 9326	1	Secharm	Swinging arm	D82,5x456 40-Zähne
9	555 4512	1	Lagereinheit	Bearing unit	30x120x100 M24x1,5
10	305 8924	2	Sicherungsring	Retaining ring	62x2 DIN472
11	319 8760	1	Schrägkugellager doppelreihig	Bearing	30/62/30 RSR
12	323 0418	1	Schutzkappe	Cap	D79/75/30x8 Zn
13	323 5011	1	Lauftring	Race ring	D45/30x20,5
14	323 8301	1	Kassettdichtung	Sealing	RWDR 45x70x14 75 NBR 106200
15	455 0310	1	Achse	Axle	D30x95 M24x1,5 Zn
16	455 5145	1	Lagergehäuse	Bearing housing	D120/62x56,4/100 6xD10,2

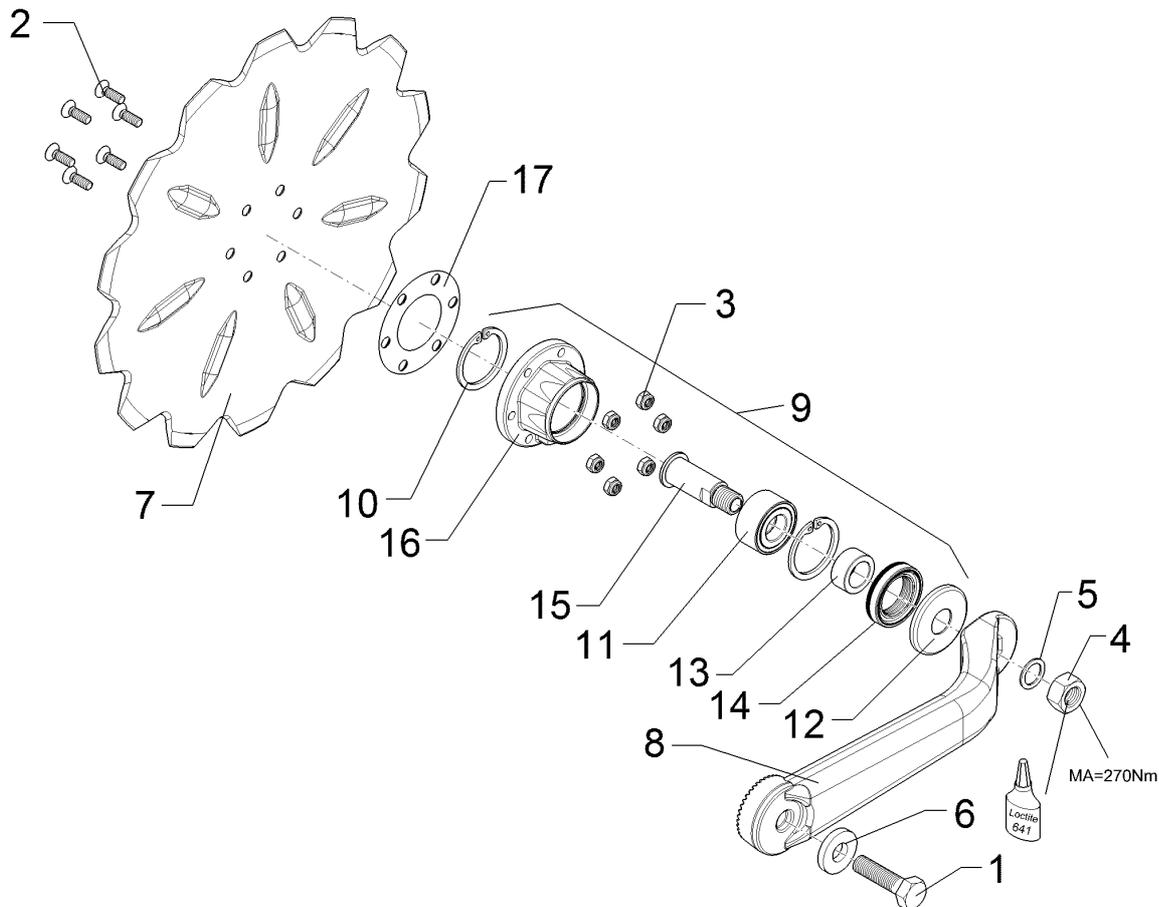

01.18

Pos.	Art.Nr.	Stck.	Artikeltext / Description		Abmessung
1	301 5414	1	Sechskantschraube	Hexagon bolt	M20x60-8.8 Zn DIN933
2	301 6123	6	Senkschraube	Countersunk bolt	M10x30-10.9 Zn DIN7991-A
3	303 0933	6	Sicherungsmutter	Selflocking nut	NM10-8 DIN985 Zn
4	303 0996	1	Sechskantmutter	Hexagon nut	M24x1,5 DIN934-8 Zn
5	305 2230	1	Stützscheibe	Supporting washer	S 25x35x2,0 DIN988 Zn
6	305 6012	1	Scheibe	Washer	21 ISO7089 Zn
7	349 0042	1	Sechscheibe	Disc	D500/100x5-Z
8	457 9326	1	Secharm	Swinging arm	D82,5x456 40-Zähne
9	555 4512	1	Lagereinheit	Bearing unit	30x120x100 M24x1,5 62x2 DIN472
10	305 8924	2	Sicherungsring	Retaining ring	62x2 DIN472
11	319 8760	1	Schrägkugellager doppelreihig	Bearing	30/62/30 RSR
12	323 0418	1	Schutzkappe	Cap	D79/75/30x8 Zn
13	323 5011	1	Lauftring	Race ring	D45/30x20,5
14	323 8301	1	Kassettdichtung	Sealing	RWDR 45x70x14 75 NBR 106200
15	455 0310	1	Achse	Axle	D30x95 M24x1,5 Zn
16	455 5145	1	Lagergehäuse	Bearing housing	D120/62x56,4/100 6xD10,2

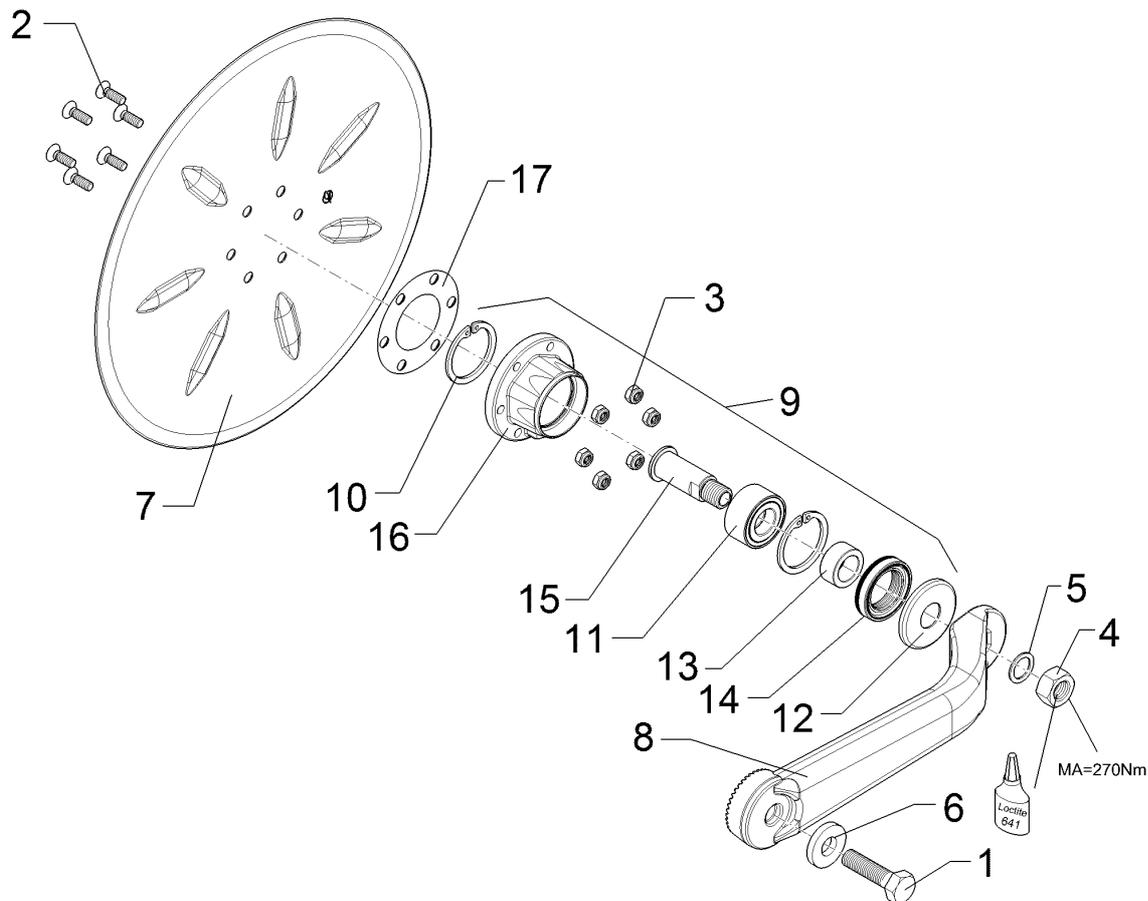

01.18

Pos.	Art.Nr.	Stck.	Artikeltext / Description		Abmessung
1	301 5414	1	Sechskantschraube	Hexagon bolt	M20x60-8.8 Zn DIN933
2	301 6123	6	Senkschraube	Countersunk bolt	M10x30-10.9 Zn DIN7991-A
3	303 0933	6	Sicherungsmutter	Selflocking nut	NM10-8 DIN985 Zn
4	303 0996	1	Sechskantmutter	Hexagon nut	M24x1,5 DIN934-8 Zn
5	305 2230	1	Stützscheibe	Supporting washer	S 25x35x2,0 DIN988 Zn
6	305 6012	1	Scheibe	Washer	21 ISO7089 Zn
7	349 0051	1	Sechscheibe	Disc	D590/100x6 GES
8	457 9326	1	Secharm	Swinging arm	D82,5x456 40-Zähne
9	555 4512	1	Lagereinheit	Bearing unit	30x120x100 M24x1,5
10	305 8924	2	Sicherungsring	Retaining ring	62x2 DIN472
11	319 8760	1	Schrägkugellager doppelreihig	Bearing	30/62/30 RSR
12	323 0418	1	Schutzkappe	Cap	D79/75/30x8 Zn
13	323 5011	1	Lauftring	Race ring	D45/30x20,5
14	323 8301	1	Kassettdichtung	Sealing	RWDR 45x70x14 75 NBR 106200
15	455 0310	1	Achse	Axle	D30x95 M24x1,5 Zn
16	455 5145	1	Lagergehäuse	Bearing housing	D120/62x56,4/100 6xD10,2

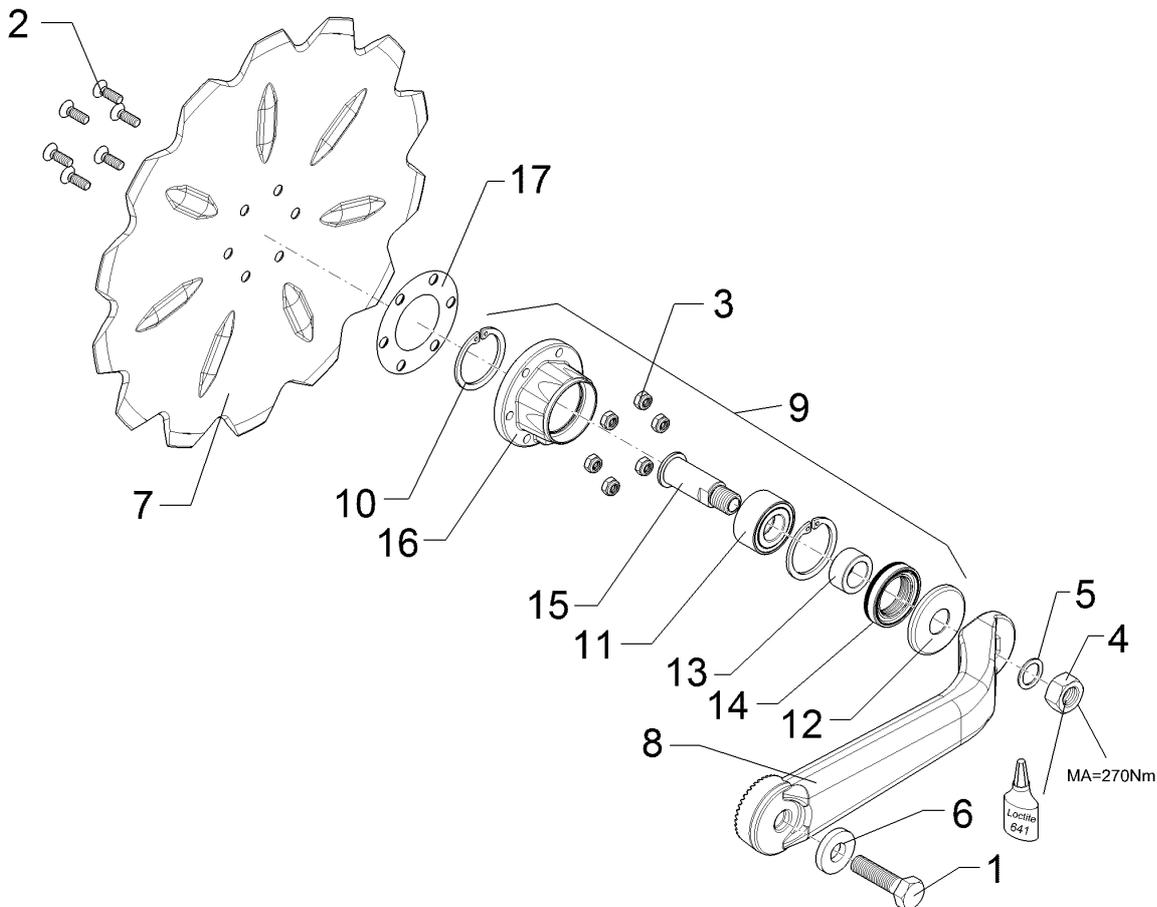

01.18

Pos.	Art.Nr.	Stck.	Artikeltext / Description		Abmessung
1	301 5414	1	Sechskantschraube	Hexagon bolt	M20x60-8.8 Zn DIN933
2	301 6123	6	Senkschraube	Countersunk bolt	M10x30-10.9 Zn DIN7991-A
3	303 0933	6	Sicherungsmutter	Selflocking nut	NM10-8 DIN985 Zn
4	303 0996	1	Sechskantmutter	Hexagon nut	M24x1,5 DIN934-8 Zn
5	305 2230	1	Stützscheibe	Supporting washer	S 25x35x2,0 DIN988 Zn
6	305 6012	1	Scheibe	Washer	21 ISO7089 Zn
7	349 0050	1	Sechscheibe	Disc	D590/100x6 GEZ
8	457 9326	1	Secharm	Swinging arm	D82,5x456 40-Zähne
9	555 4512	1	Lagereinheit	Bearing unit	30x120x100 M24x1,5
10	305 8924	2	Sicherungsring	Retaining ring	62x2 DIN472
11	319 8760	1	Schrägkugellager doppelreihig	Bearing	30/62/30 RSR
12	323 0418	1	Schutzkappe	Cap	D79/75/30x8 Zn
13	323 5011	1	Lauftring	Race ring	D45/30x20,5
14	323 8301	1	Kassettdichtung	Sealing	RWDR 45x70x14 75 NBR 106200
15	455 0310	1	Achse	Axle	D30x95 M24x1,5 Zn
16	455 5145	1	Lagergehäuse	Bearing housing	D120/62x56,4/100 6xD10,2

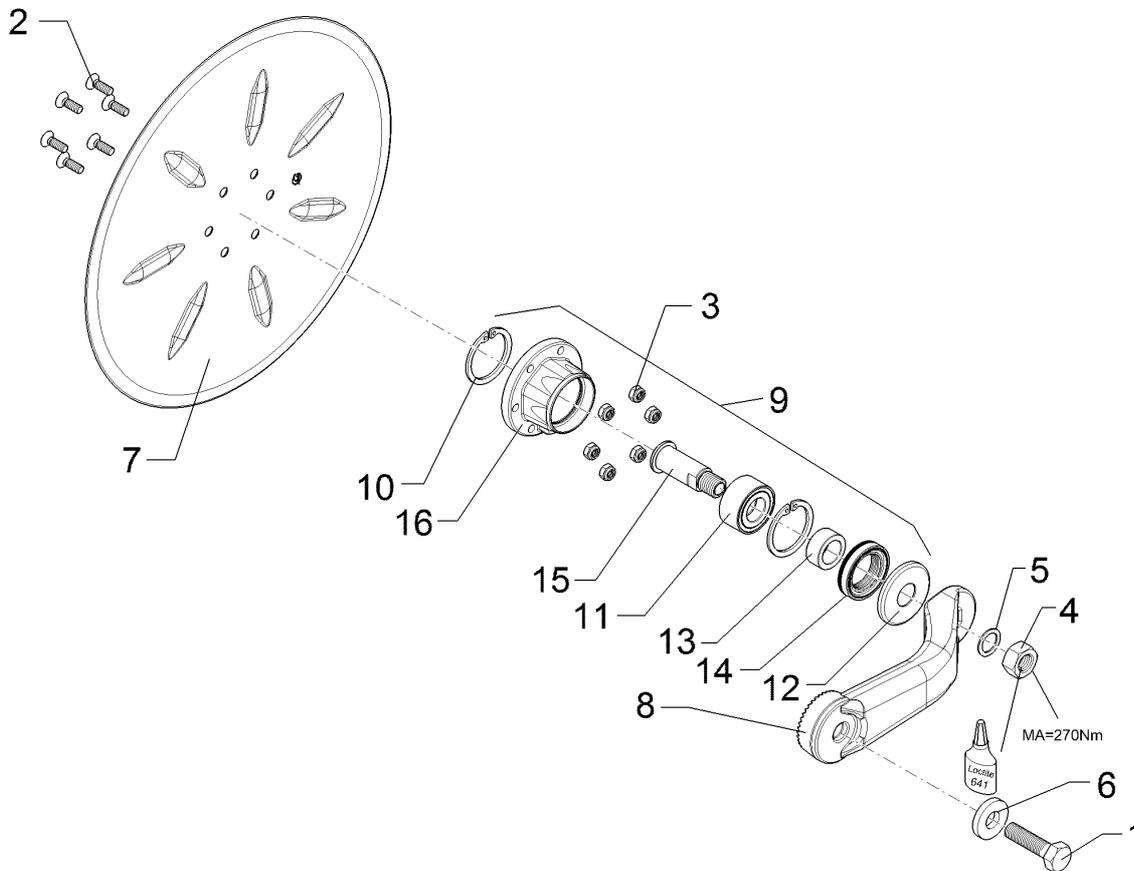

01.18

Pos.	Art.Nr.	Stck.	Artikeltext / Description		Abmessung
1	301 5414	1	Sechskantschraube	Hexagon bolt	M20x60-8.8 Zn DIN933
2	301 6123	6	Senkschraube	Countersunk bolt	M10x30-10.9 Zn DIN7991-A
3	303 0933	6	Sicherungsmutter	Selflocking nut	NM10-8 DIN985 Zn
4	303 0996	1	Sechskantmutter	Hexagon nut	M24x1,5 DIN934-8 Zn
5	305 2230	1	Stützscheibe	Supporting washer	S 25x35x2,0 DIN988 Zn
6	305 6012	1	Scheibe	Washer	21 ISO7089 Zn
7	349 0029	1	Sechscheibe	Disc	D500/100x5 G
8	457 9327	1	Secharm	Swinging arm	D82,5x331 40-Zähne
9	555 4512	1	Lagereinheit	Bearing unit	30x120x100 M24x1,5
10	305 8924	2	Sicherungsring	Retaining ring	62x2 DIN472
11	319 8760	1	Schrägkugellager doppelreihig	Bearing	30/62/30 RSR
12	323 0418	1	Schutzkappe	Cap	D79/75/30x8 Zn
13	323 5011	1	Lauftring	Race ring	D45/30x20,5
14	323 8301	1	Kassettdichtung	Sealing	RWDR 45x70x14 75 NBR 106200
15	455 0310	1	Achse	Axle	D30x95 M24x1,5 Zn
16	455 5145	1	Lagergehäuse	Bearing housing	D120/62x56,4/100 6xD10,2

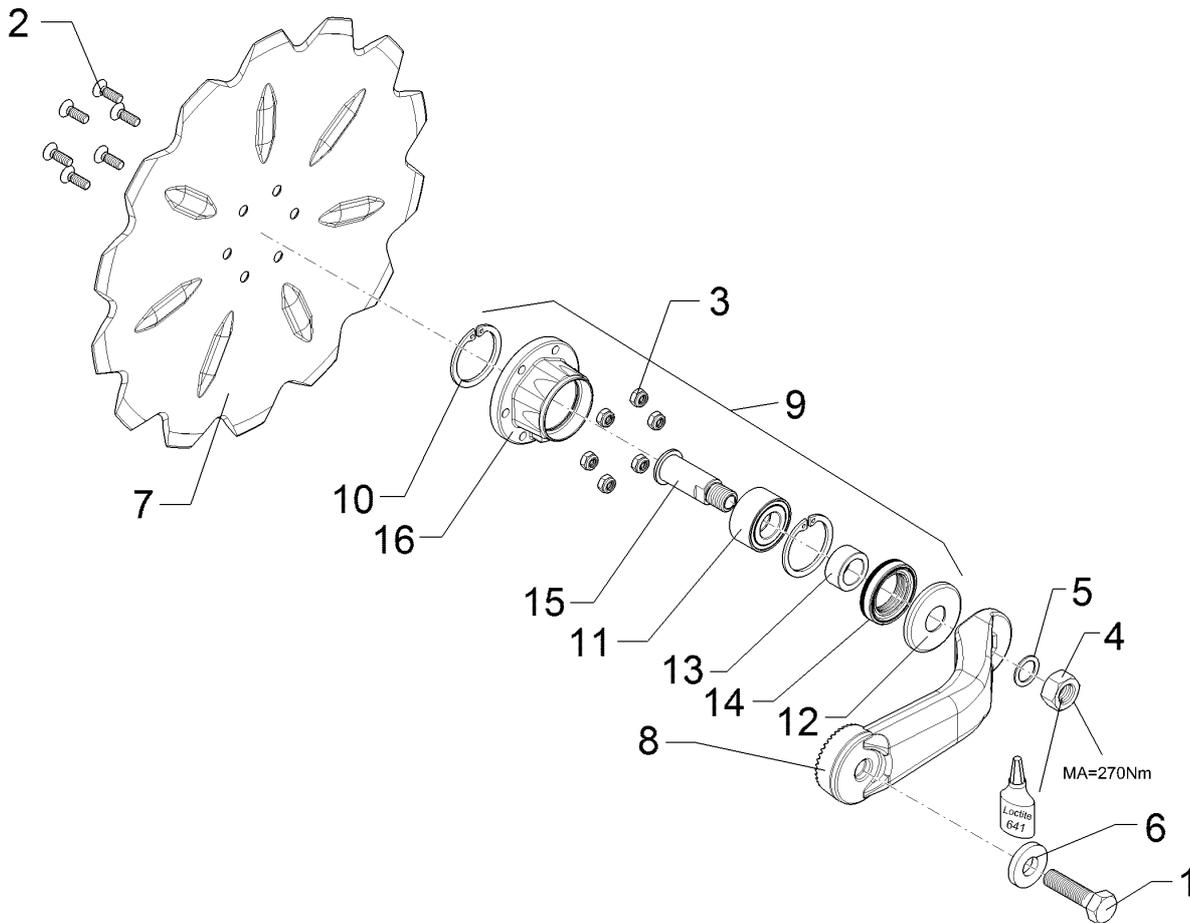

01.18

Pos.	Art.Nr.	Stck.	Artikeltext / Description		Abmessung
1	301 5414	1	Sechskantschraube	Hexagon bolt	M20x60-8.8 Zn DIN933
2	301 6123	6	Senkschraube	Countersunk bolt	M10x30-10.9 Zn DIN7991-A
3	303 0933	6	Sicherungsmutter	Selflocking nut	NM10-8 DIN985 Zn
4	303 0996	1	Sechskantmutter	Hexagon nut	M24x1,5 DIN934-8 Zn
5	305 2230	1	Stützscheibe	Supporting washer	S 25x35x2,0 DIN988 Zn
6	305 6012	1	Scheibe	Washer	21 ISO7089 Zn
7	349 0042	1	Sechscheibe	Disc	D500/100x5-Z
8	457 9327	1	Secharm	Swinging arm	D82,5x331 40-Zähne
9	555 4512	1	Lagereinheit	Bearing unit	30x120x100 M24x1,5
10	305 8924	2	Sicherungsring	Retaining ring	62x2 DIN472
11	319 8760	1	Schrägkugellager doppelreihig	Bearing	30/62/30 RSR
12	323 0418	1	Schutzkappe	Cap	D79/75/30x8 Zn
13	323 5011	1	Lauftring	Race ring	D45/30x20,5
14	323 8301	1	Kassettdichtung	Sealing	RWDR 45x70x14 75 NBR 106200
15	455 0310	1	Achse	Axle	D30x95 M24x1,5 Zn
16	455 5145	1	Lagergehäuse	Bearing housing	D120/62x56,4/100 6xD10,2

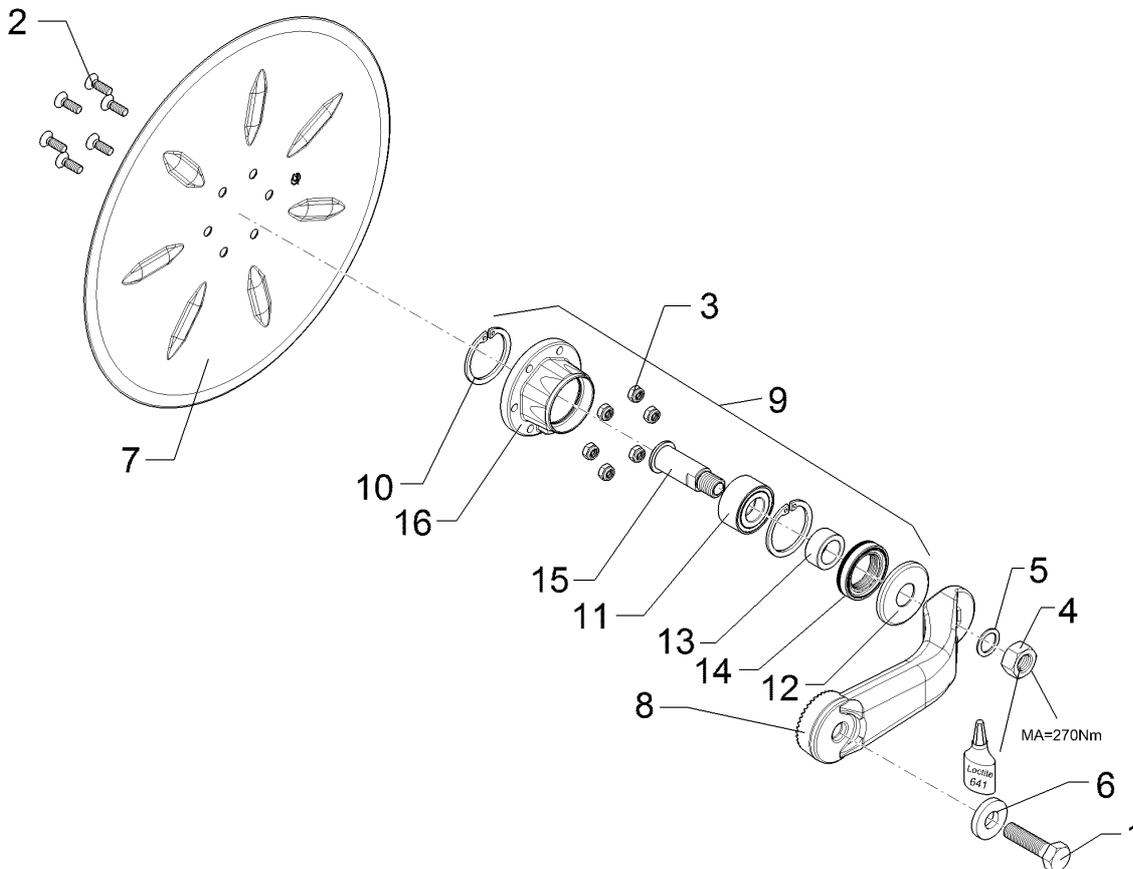

01.18

Pos.	Art.Nr.	Stck.	Artikeltext / Description		Abmessung
1	301 5414	1	Sechskantschraube	Hexagon bolt	M20x60-8.8 Zn DIN933
2	301 6123	6	Senkschraube	Countersunk bolt	M10x30-10.9 Zn DIN7991-A
3	303 0933	6	Sicherungsmutter	Selflocking nut	NM10-8 DIN985 Zn
4	303 0996	1	Sechskantmutter	Hexagon nut	M24x1,5 DIN934-8 Zn
5	305 2230	1	Stützscheibe	Supporting washer	S 25x35x2,0 DIN988 Zn
6	305 6012	1	Scheibe	Washer	21 ISO7089 Zn
7	349 0051	1	Sechscheibe	Disc	D590/100x6 GES
8	457 9327	1	Secharm	Swinging arm	D82,5x331 40-Zähne
9	555 4512	1	Lagereinheit	Bearing unit	30x120x100 M24x1,5 62x2 DIN472
10	305 8924	2	Sicherungsring	Retaining ring	
11	319 8760	1	Schrägkugellager doppelreihig	Bearing	30/62/30 RSR
12	323 0418	1	Schutzkappe	Cap	D79/75/30x8 Zn
13	323 5011	1	Lauftring	Race ring	D45/30x20,5
14	323 8301	1	Kassettdichtung	Sealing	RWDR 45x70x14 75 NBR 106200
15	455 0310	1	Achse	Axle	D30x95 M24x1,5 Zn
16	455 5145	1	Lagergehäuse	Bearing housing	D120/62x56,4/100 6xD10,2

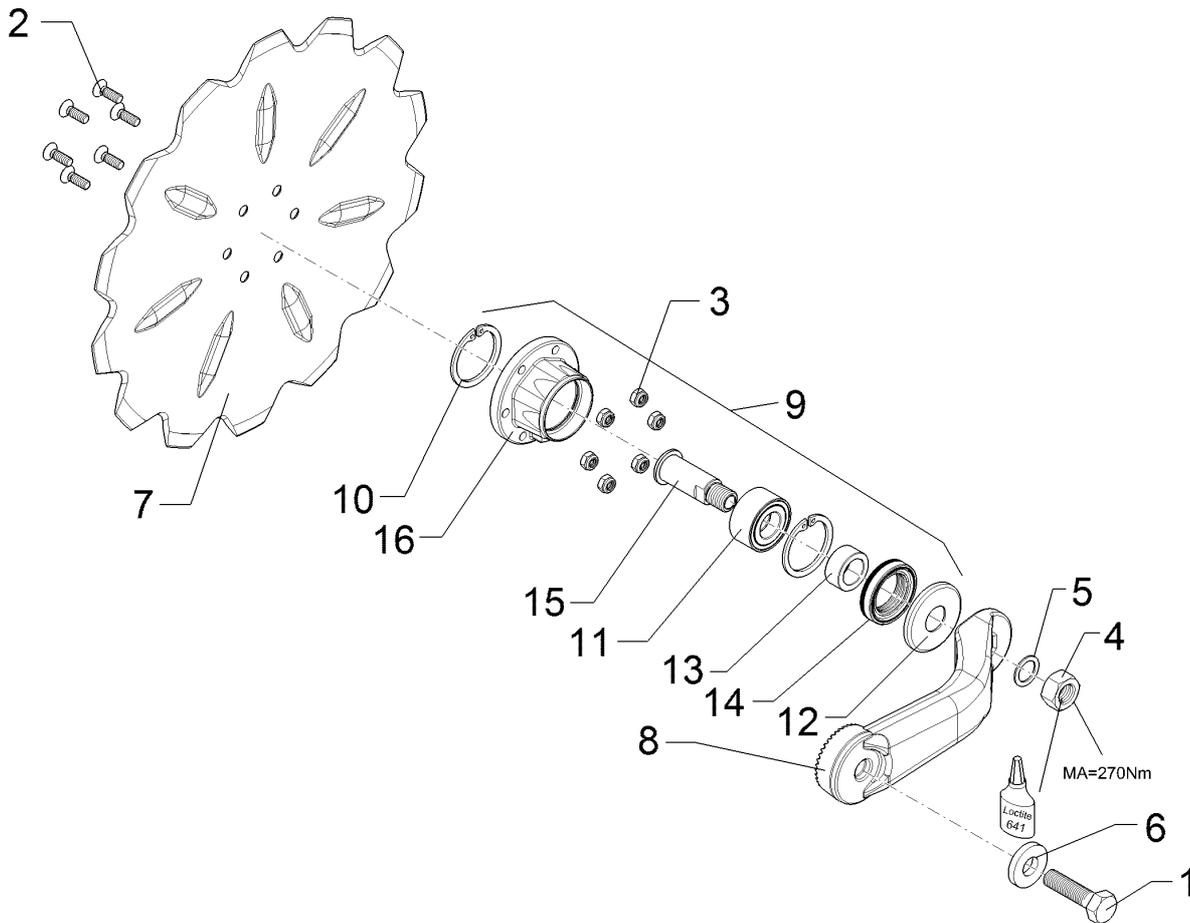

01.18

Pos.	Art.Nr.	Stck.	Artikeltext / Description		Abmessung
1	301 5414	1	Sechskantschraube	Hexagon bolt	M20x60-8.8 Zn DIN933
2	301 6123	6	Senkschraube	Countersunk bolt	M10x30-10.9 Zn DIN7991-A
3	303 0933	6	Sicherungsmutter	Selflocking nut	NM10-8 DIN985 Zn
4	303 0996	1	Sechskantmutter	Hexagon nut	M24x1,5 DIN934-8 Zn
5	305 2230	1	Stützscheibe	Supporting washer	S 25x35x2,0 DIN988 Zn
6	305 6012	1	Scheibe	Washer	21 ISO7089 Zn
7	349 0050	1	Sechscheibe	Disc	D590/100x6 GEZ
8	457 9327	1	Secharm	Swinging arm	D82,5x331 40-Zähne
9	555 4512	1	Lagereinheit	Bearing unit	30x120x100 M24x1,5
10	305 8924	2	Sicherungsring	Retaining ring	62x2 DIN472
11	319 8760	1	Schrägkugellager doppelreihig	Bearing	30/62/30 RSR
12	323 0418	1	Schutzkappe	Cap	D79/75/30x8 Zn
13	323 5011	1	Lauftring	Race ring	D45/30x20,5
14	323 8301	1	Kassettdichtung	Sealing	RWDR 45x70x14 75 NBR 106200
15	455 0310	1	Achse	Axle	D30x95 M24x1,5 Zn
16	455 5145	1	Lagergehäuse	Bearing housing	D120/62x56,4/100 6xD10,2

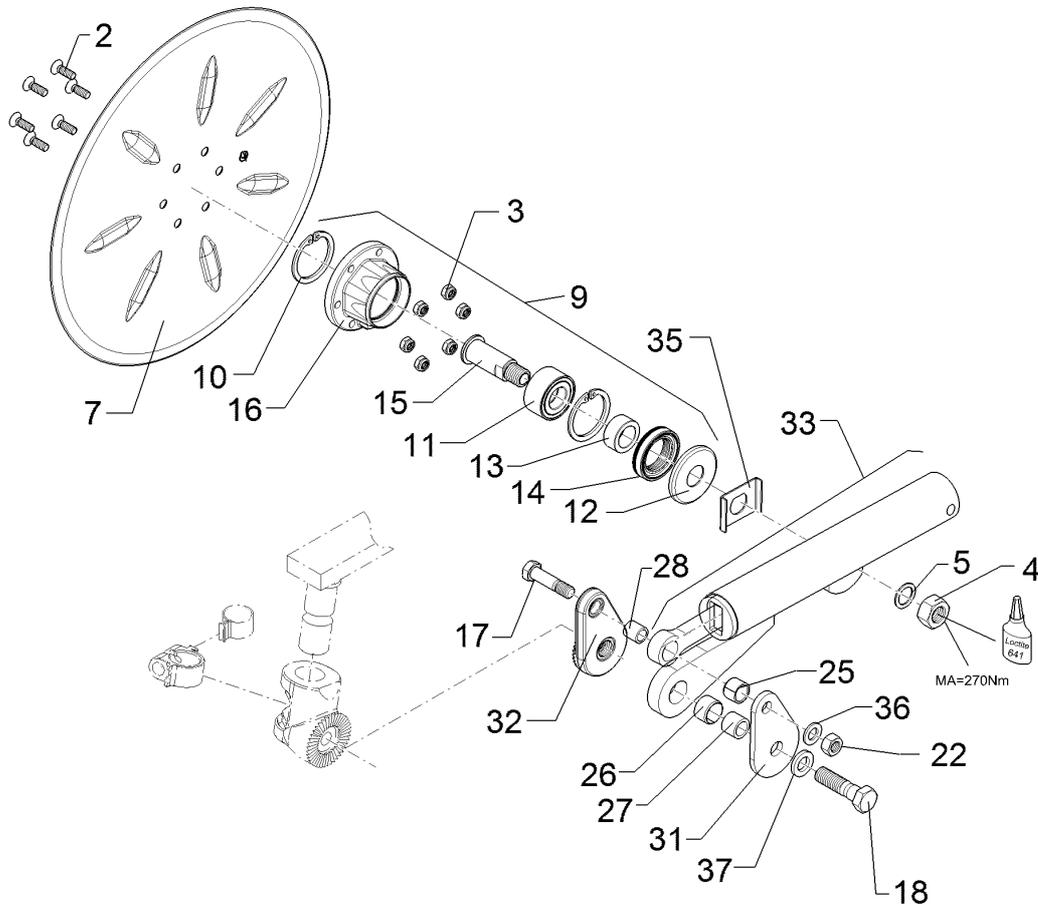

01.18

Pos.	Art.Nr.	Stck.	Artikeltext / Description	Abmessung	
2	301 6123	6	Senkschraube	Countersunk bolt	M10x30-10.9 Zn DIN7991-A
3	303 0933	6	Sicherungsmutter	Selflocking nut	NM10-8 DIN985 Zn
4	303 0996	1	Sechskantmutter	Hexagon nut	M24x1,5 DIN934-8 Zn
5	305 2230	1	Stützscheibe	Supporting washer	S 25x35x2,0 DIN988 Zn
7	349 0029	1	Sechsscheibe	Disc	D500/100x5 G
9	555 4512	1	Lagereinheit	Bearing unit	30x120x100 M24x1,5
10	305 8924	2	Sicherungsring	Retaining ring	62x2 DIN472
11	319 8760	1	Schrägkugellager doppelreihig	Bearing	30/62/30 RSR
12	323 0418	1	Schutzkappe	Cap	D79/75/30x8 Zn
13	323 5011	1	Lauftring	Race ring	D45/30x20,5
14	323 8301	1	Kassettendichtung	Sealing	RWDR 45x70x14 75 NBR 106200
15	455 0310	1	Achse	Axle	D30x95 M24x1,5 Zn
16	455 5145	1	Lagergehäuse	Bearing housing	D120/62x56,4/100 6xD10,2
17	301 3870	1	Sechskantschraube spz.	Hexagon bolt	M16x65-10.9 Zn
18	301 4603	1	Sechskantschraube spz.	Hexagon bolt	M20x75-8.8 Zn
22	303 1015	1	Sechskantmutter	Hexagon nut	M16 DIN934-8 Zn
25	317 3341	1	Einspannbuchse	Expansion bush	EG22/28x20-DIN1498
26	317 3352	1	Einspannbuchse mit Presssitz	Expansion bush	EG28/32x20
27	317 6657	1	Buchse	Bush	D20/28x22
28	317 6658	1	Buchse	Bush	D16/22x22

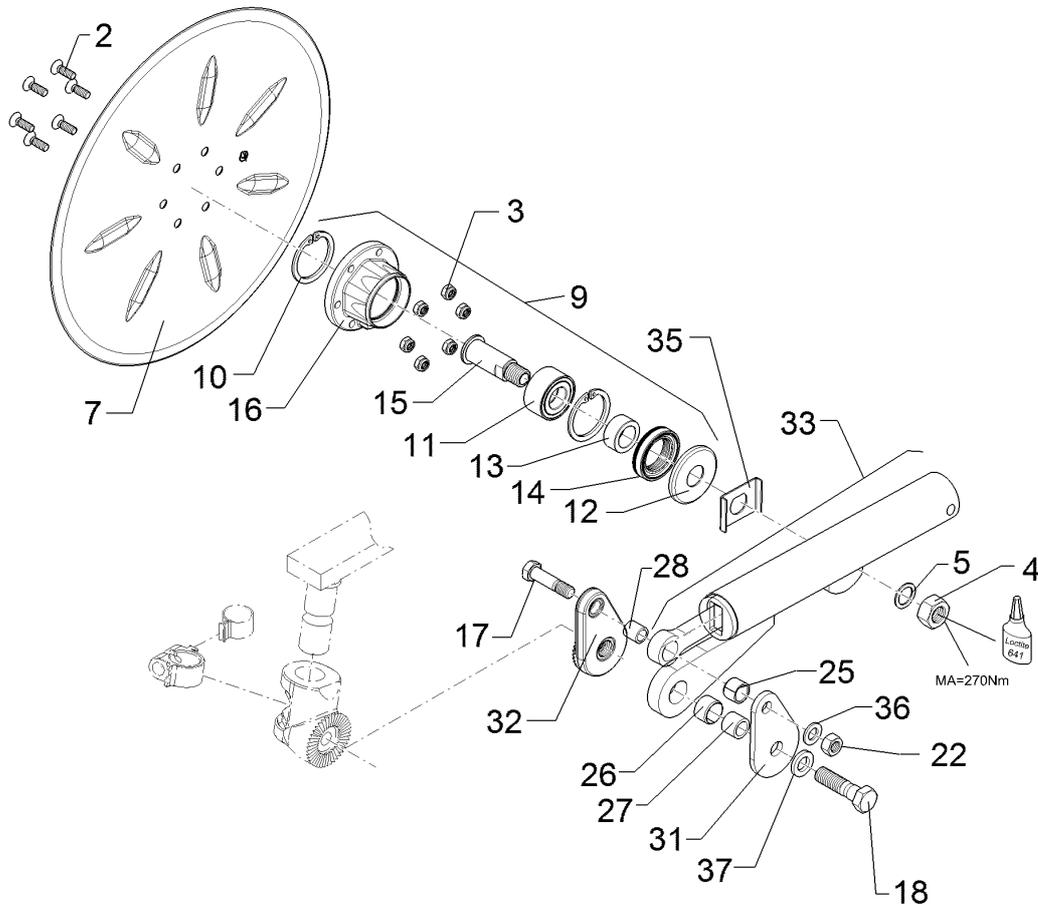

01.18

Pos.	Art.Nr.	Stck.	Artikeltext / Description		Abmessung
31	457 9323	1	Platte	Plate	8x80x135 1xD20,5 1xD16,5
32	457 9324	1	Zahnkonsole	Hirth-type bracket	D77/20,5 40 Zähne
33	55710024	1	Federelement	Spring unit	55710024
35	305 1330	1	Verdrehsicherung	Locking	50x3x70 D30 Zn
36	305 6141	1	Scheibe	Washer	17/30x3 DIN/ISO-7089
37	305 6012	1	Scheibe	Washer	21 ISO7089 Zn

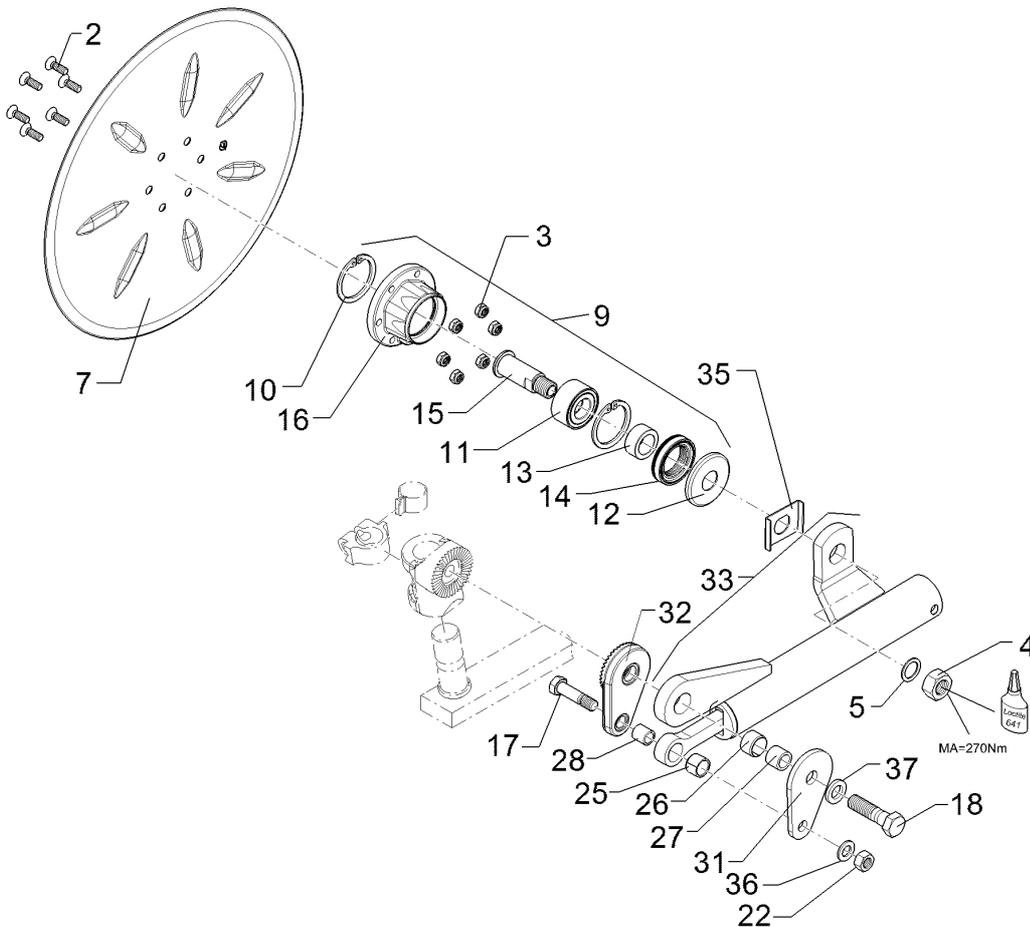

01.18

Pos.	Art.Nr.	Stck.	Artikeltext / Description	Abmessung	
2	301 6123	6	Senkschraube	Countersunk bolt	M10x30-10.9 Zn DIN7991-A
3	303 0933	6	Sicherungsmutter	Selflocking nut	NM10-8 DIN985 Zn
4	303 0996	1	Sechskantmutter	Hexagon nut	M24x1,5 DIN934-8 Zn
5	305 2230	1	Stützscheibe	Supporting washer	S 25x35x2,0 DIN988 Zn
7	349 0029	1	Sechscheibe	Disc	D500/100x5 G
9	555 4512	1	Lagereinheit	Bearing unit	30x120x100 M24x1,5
10	305 8924	2	Sicherungsring	Retaining ring	62x2 DIN472
11	319 8760	1	Schrägkugellager doppelreihig	Bearing	30/62/30 RSR
12	323 0418	1	Schutzkappe	Cap	D79/75/30x8 Zn
13	323 5011	1	Lauftring	Race ring	D45/30x20,5
14	323 8301	1	Kassettendichtung	Sealing	RWDR 45x70x14 75 NBR 106200
15	455 0310	1	Achse	Axle	D30x95 M24x1,5 Zn
16	455 5145	1	Lagergehäuse	Bearing housing	D120/62x56,4/100 6xD10,2
17	301 3870	1	Sechskantschraube spz.	Hexagon bolt	M16x65-10.9 Zn
18	301 4603	1	Sechskantschraube spz.	Hexagon bolt	M20x75-8.8 Zn
22	303 1015	1	Sechskantmutter	Hexagon nut	M16 DIN934-8 Zn
25	317 3341	1	Einspannbuchse	Expansion bush	EG22/28x20-DIN1498
26	317 3352	1	Einspannbuchse mit Presssitz	Expansion bush	EG28/32x20
27	317 6657	1	Buchse	Bush	D20/28x22
28	317 6658	1	Buchse	Bush	D16/22x22

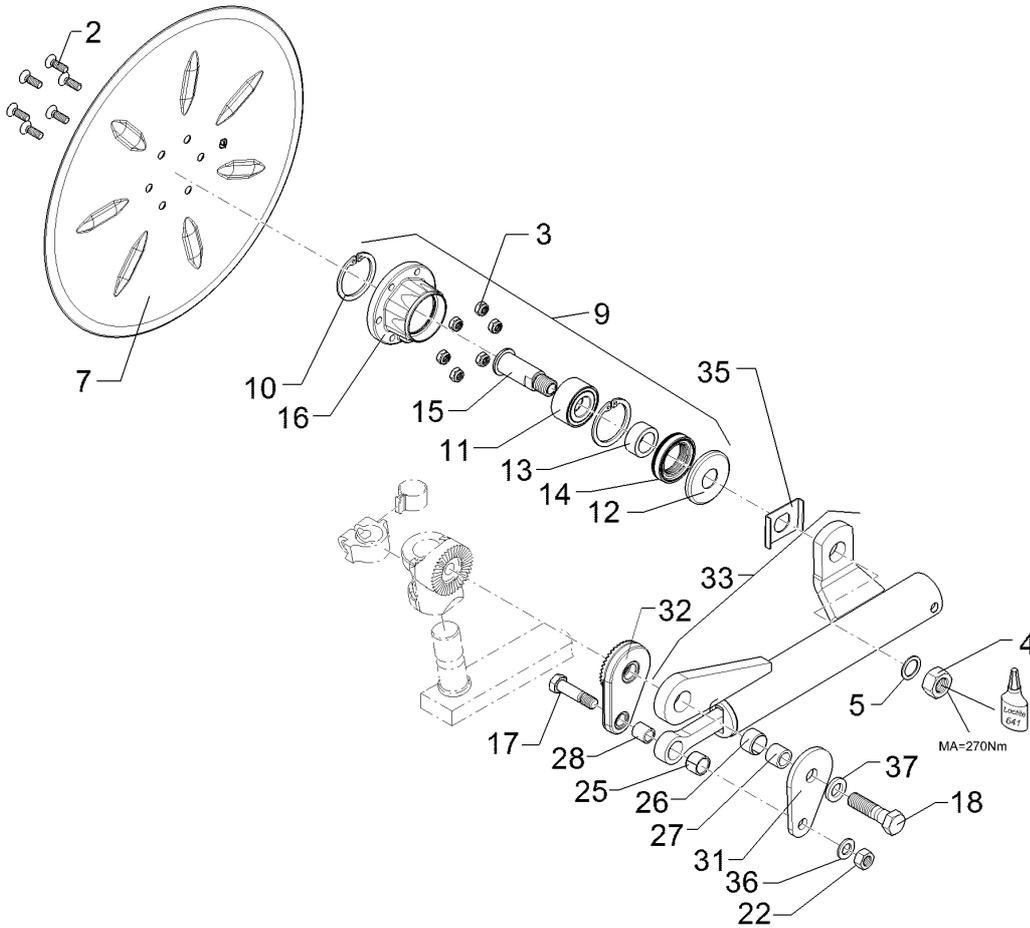

01.18

Pos.	Art.Nr.	Stck.	Artikeltext / Description	Abmessung	
31	457 9323	1	Platte	Plate	8x80x135 1xD20,5 1xD16,5
32	457 9324	1	Zahnkonsole	Hirth-type bracket	D77/20,5 40 Zähne
33	55710025	1	Federelement	Spring unit	55710025
35	305 1330	1	Verdrehsicherung	Locking	50x3x70 D30 Zn
36	305 6141	1	Scheibe	Washer	17/30x3 DIN/ISO-7089
37	305 6012	1	Scheibe	Washer	21 ISO7089 Zn

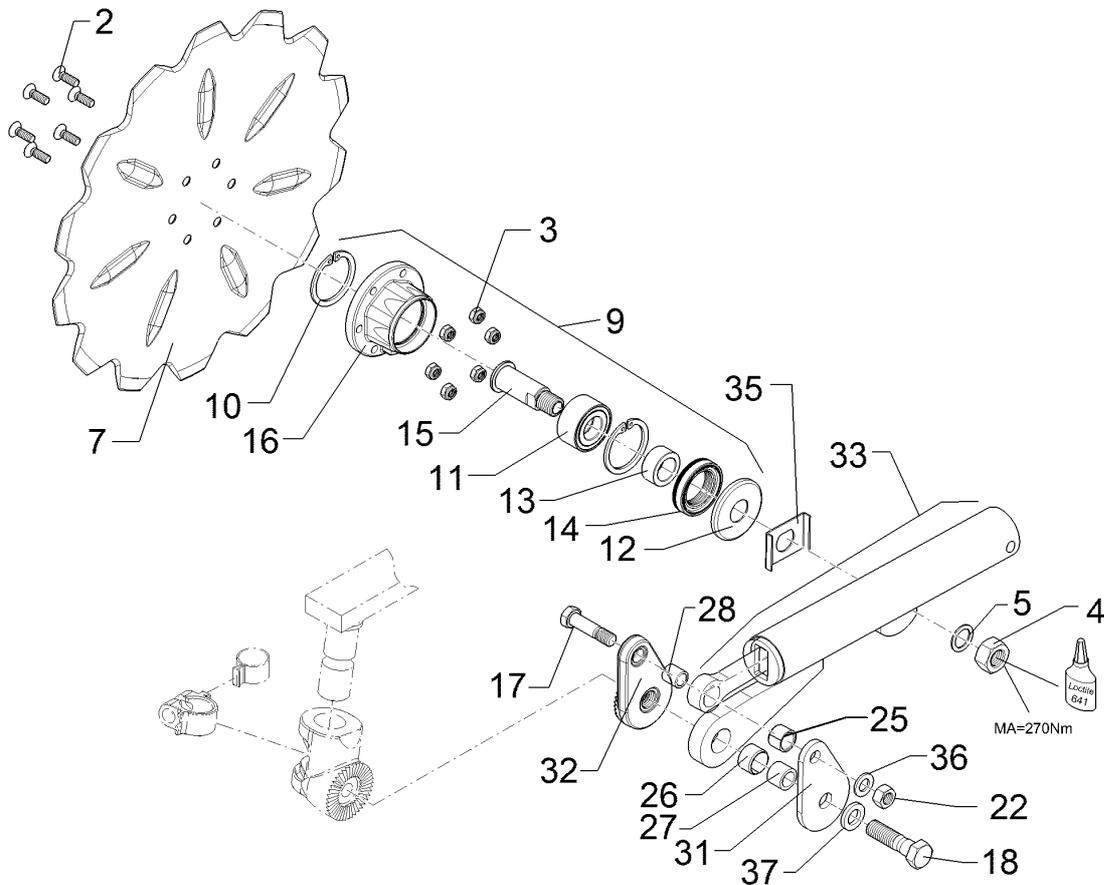

01.18

Pos.	Art.Nr.	Stck.	Artikeltext / Description		Abmessung
2	301 6123	6	Senkschraube	Countersunk bolt	M10x30-10.9 Zn DIN7991-A
3	303 0933	6	Sicherungsmutter	Selflocking nut	NM10-8 DIN985 Zn
4	303 0996	1	Sechskantmutter	Hexagon nut	M24x1,5 DIN934-8 Zn
5	305 2230	1	Stützscheibe	Supporting washer	S 25x35x2,0 DIN988 Zn
7	349 0042	1	Sechscheibe	Disc	D500/100x5-Z
9	555 4512	1	Lagereinheit	Bearing unit	30x120x100 M24x1,5
10	305 8924	2	Sicherungsring	Retaining ring	62x2 DIN472
11	319 8760	1	Schrägkugellager doppelreihig	Bearing	30/62/30 RSR
12	323 0418	1	Schutzkappe	Cap	D79/75/30x8 Zn
13	323 5011	1	Lauftring	Race ring	D45/30x20,5
14	323 8301	1	Kassettendichtung	Sealing	RWDR 45x70x14 75 NBR 106200
15	455 0310	1	Achse	Axle	D30x95 M24x1,5 Zn
16	455 5145	1	Lagergehäuse	Bearing housing	D120/62x56,4/100 6xD10,2
17	301 3870	1	Sechskantschraube spz.	Hexagon bolt	M16x65-10.9 Zn
18	301 4603	1	Sechskantschraube spz.	Hexagon bolt	M20x75-8.8 Zn
22	303 1015	1	Sechskantmutter	Hexagon nut	M16 DIN934-8 Zn
25	317 3341	1	Einspannbuchse	Expansion bush	EG22/28x20-DIN1498
26	317 3352	1	Einspannbuchse mit Presssitz	Expansion bush	EG28/32x20
27	317 6657	1	Buchse	Bush	D20/28x22
28	317 6658	1	Buchse	Bush	D16/22x22

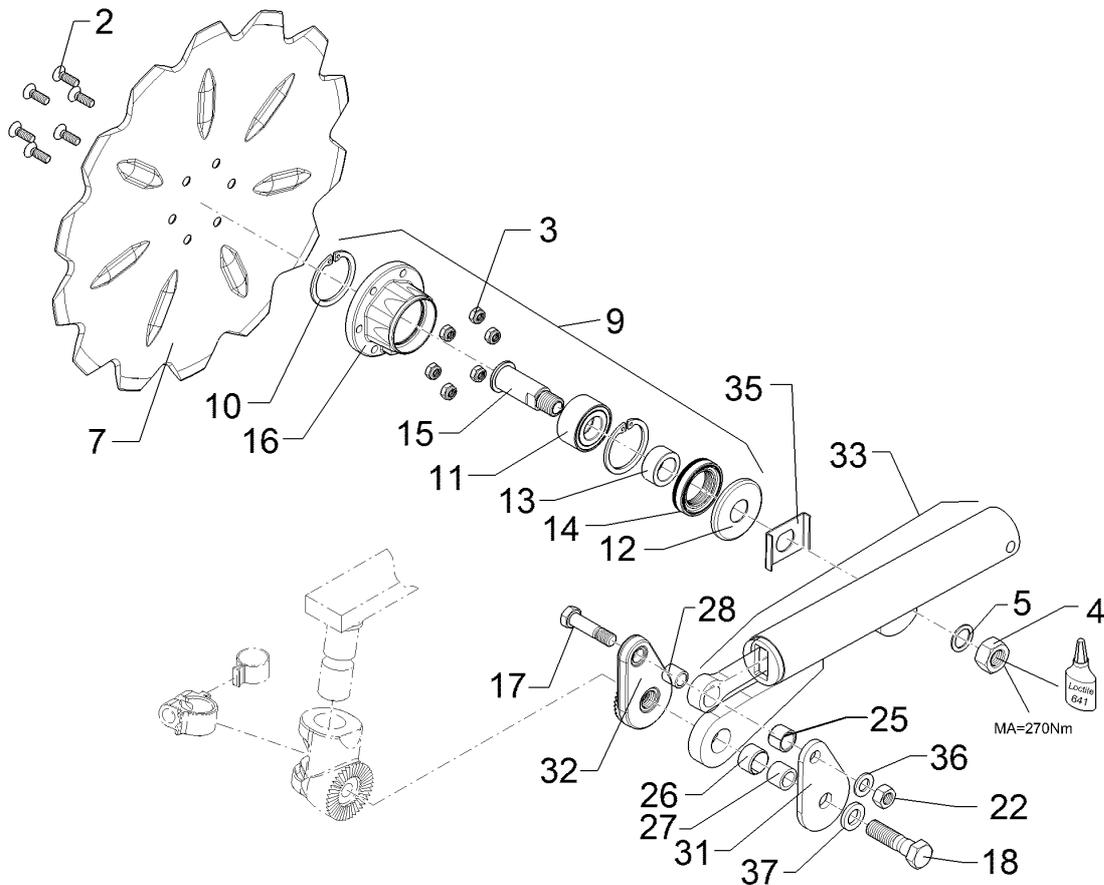

01.18

Pos.	Art.Nr.	Stck.	Artikeltext / Description		Abmessung
31	457 9323	1	Platte	Plate	8x80x135 1xD20,5 1xD16,5
32	457 9324	1	Zahnkonsole	Hirth-type bracket	D77/20,5 40 Zähne
33	55710024	1	Federelement	Spring unit	55710024
35	305 1330	1	Verdrehsicherung	Locking	50x3x70 D30 Zn
36	305 6141	1	Scheibe	Washer	17/30x3 DIN/ISO-7089
37	305 6012	1	Scheibe	Washer	21 ISO7089 Zn

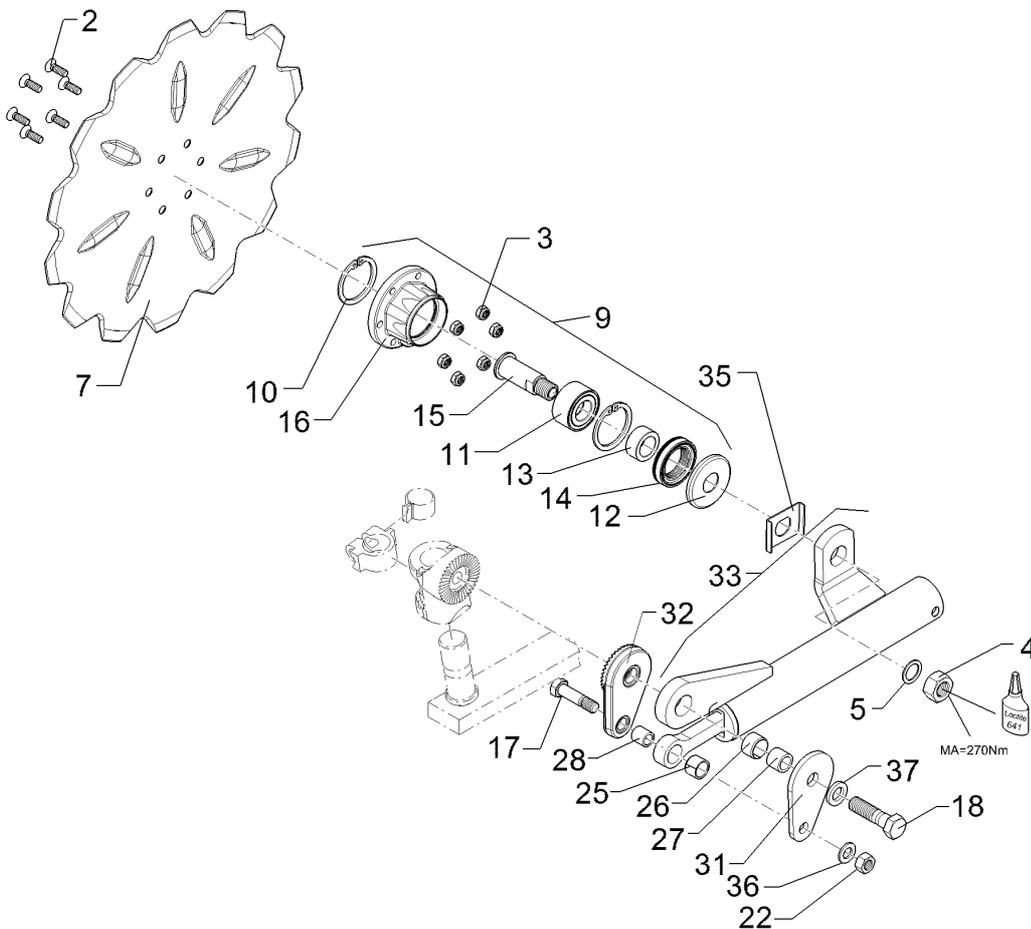

01.18

Pos.	Art.Nr.	Stck.	Artikeltext / Description		Abmessung
2	301 6123	6	Senkschraube	Countersunk bolt	M10x30-10.9 Zn DIN7991-A
3	303 0933	6	Sicherungsmutter	Selflocking nut	NM10-8 DIN985 Zn
4	303 0996	1	Sechskantmutter	Hexagon nut	M24x1,5 DIN934-8 Zn
5	305 2230	1	Stützscheibe	Supporting washer	S 25x35x2,0 DIN988 Zn
7	349 0042	1	Sechscheibe	Disc	D500/100x5-Z
9	555 4512	1	Lagereinheit	Bearing unit	30x120x100 M24x1,5
10	305 8924	2	Sicherungsring	Retaining ring	62x2 DIN472
11	319 8760	1	Schrägkugellager doppelreihig	Bearing	30/62/30 RSR
12	323 0418	1	Schutzkappe	Cap	D79/75/30x8 Zn
13	323 5011	1	Lauftring	Race ring	D45/30x20,5
14	323 8301	1	Kassettendichtung	Sealing	RWDR 45x70x14 75 NBR 106200
15	455 0310	1	Achse	Axle	D30x95 M24x1,5 Zn
16	455 5145	1	Lagergehäuse	Bearing housing	D120/62x56,4/100 6xD10,2
17	301 3870	1	Sechskantschraube spz.	Hexagon bolt	M16x65-10.9 Zn
18	301 4603	1	Sechskantschraube spz.	Hexagon bolt	M20x75-8.8 Zn
22	303 1015	1	Sechskantmutter	Hexagon nut	M16 DIN934-8 Zn
25	317 3341	1	Einspannbuchse	Expansion bush	EG22/28x20-DIN1498
26	317 3352	1	Einspannbuchse mit Presssitz	Expansion bush	EG28/32x20
27	317 6657	1	Buchse	Bush	D20/28x22
28	317 6658	1	Buchse	Bush	D16/22x22

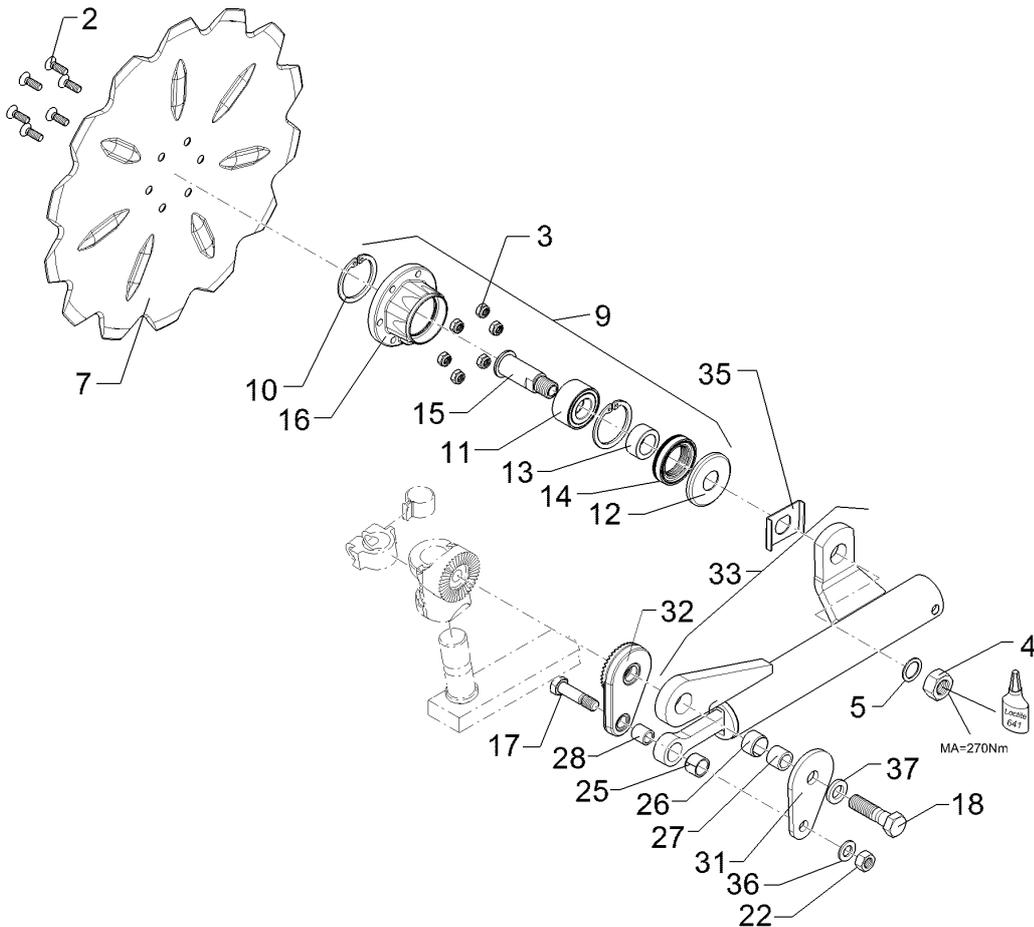

01.18

Pos.	Art.Nr.	Stck.	Artikeltext / Description		Abmessung
31	457 9323	1	Platte	Plate	8x80x135 1xD20,5 1xD16,5
32	457 9324	1	Zahnkonsole	Hirth-type bracket	D77/20,5 40 Zähne
33	55710025	1	Federelement	Spring unit	55710025
35	305 1330	1	Verdrehsicherung	Locking	50x3x70 D30 Zn
36	305 6141	1	Scheibe	Washer	17/30x3 DIN/ISO-7089
37	305 6012	1	Scheibe	Washer	21 ISO7089 Zn

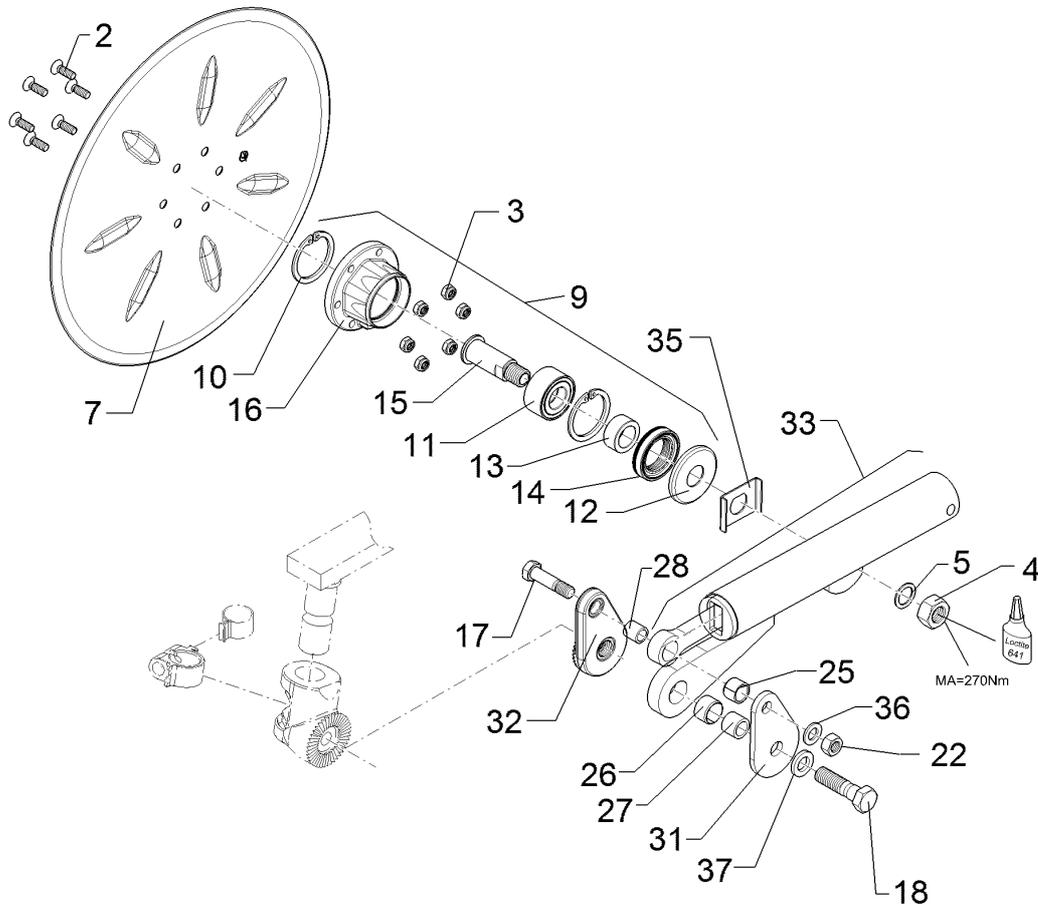

01.18

Pos.	Art.Nr.	Stck.	Artikeltext / Description	Abmessung	
2	301 6123	6	Senkschraube	Countersunk bolt	M10x30-10.9 Zn DIN7991-A
3	303 0933	6	Sicherungsmutter	Selflocking nut	NM10-8 DIN985 Zn
4	303 0996	1	Sechskantmutter	Hexagon nut	M24x1,5 DIN934-8 Zn
5	305 2230	1	Stützscheibe	Supporting washer	S 25x35x2,0 DIN988 Zn
7	349 0051	1	Sechsscheibe	Disc	D590/100x6 GES
9	555 4512	1	Lagereinheit	Bearing unit	30x120x100 M24x1,5
10	305 8924	2	Sicherungsring	Retaining ring	62x2 DIN472
11	319 8760	1	Schrägkugellager doppelreihig	Bearing	30/62/30 RSR
12	323 0418	1	Schutzkappe	Cap	D79/75/30x8 Zn
13	323 5011	1	Lauftring	Race ring	D45/30x20,5
14	323 8301	1	Kassettendichtung	Sealing	RWDR 45x70x14 75 NBR 106200
15	455 0310	1	Achse	Axle	D30x95 M24x1,5 Zn
16	455 5145	1	Lagergehäuse	Bearing housing	D120/62x56,4/100 6xD10,2
17	301 3870	1	Sechskantschraube spz.	Hexagon bolt	M16x65-10.9 Zn
18	301 4603	1	Sechskantschraube spz.	Hexagon bolt	M20x75-8.8 Zn
22	303 1015	1	Sechskantmutter	Hexagon nut	M16 DIN934-8 Zn
25	317 3341	1	Einspannbuchse	Expansion bush	EG22/28x20-DIN1498
26	317 3352	1	Einspannbuchse mit Presssitz	Expansion bush	EG28/32x20
27	317 6657	1	Buchse	Bush	D20/28x22
28	317 6658	1	Buchse	Bush	D16/22x22

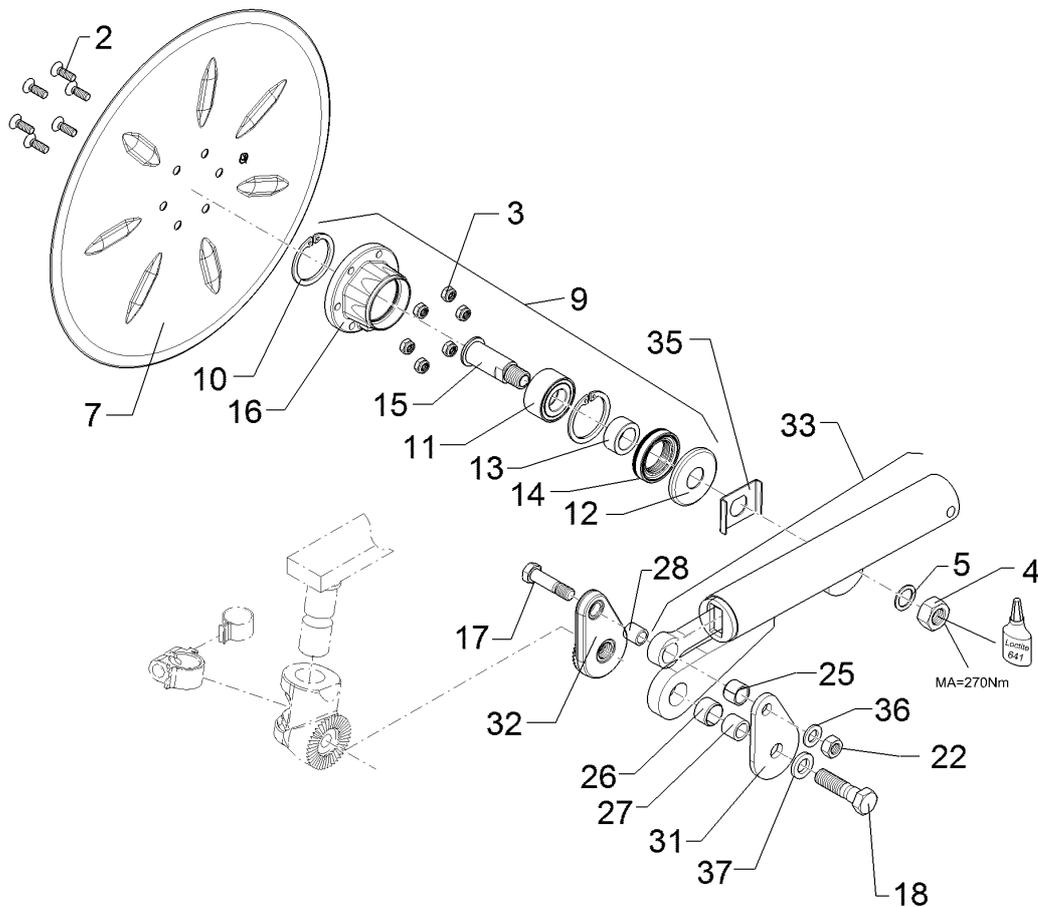

01.18

Pos.	Art.Nr.	Stck.	Artikeltext / Description		Abmessung
31	457 9323	1	Platte	Plate	8x80x135 1xD20,5 1xD16,5
32	457 9324	1	Zahnkonsole	Hirth-type bracket	D77/20,5 40 Zähne
33	55710024	1	Federelement	Spring unit	55710024
35	305 1330	1	Verdrehsicherung	Locking	50x3x70 D30 Zn
36	305 6141	1	Scheibe	Washer	17/30x3 DIN/ISO-7089
37	305 6012	1	Scheibe	Washer	21 ISO7089 Zn

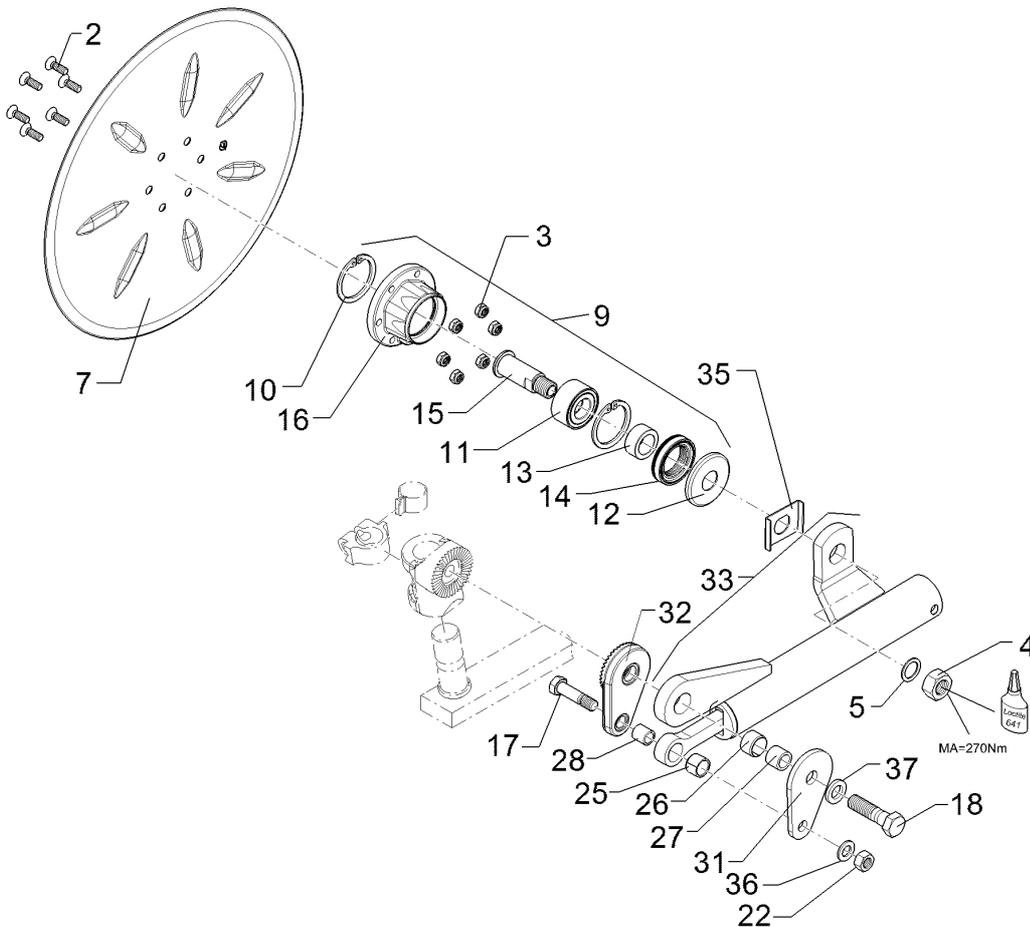

01.18

Pos.	Art.Nr.	Stck.	Artikeltext / Description	Abmessung	
2	301 6123	6	Senkschraube	Countersunk bolt	M10x30-10.9 Zn DIN7991-A
3	303 0933	6	Sicherungsmutter	Selflocking nut	NM10-8 DIN985 Zn
4	303 0996	1	Sechskantmutter	Hexagon nut	M24x1,5 DIN934-8 Zn
5	305 2230	1	Stützscheibe	Supporting washer	S 25x35x2,0 DIN988 Zn
7	349 0051	1	Sechscheibe	Disc	D590/100x6 GES
9	555 4512	1	Lagereinheit	Bearing unit	30x120x100 M24x1,5
10	305 8924	2	Sicherungsring	Retaining ring	62x2 DIN472
11	319 8760	1	Schrägkugellager doppelreihig	Bearing	30/62/30 RSR
12	323 0418	1	Schutzkappe	Cap	D79/75/30x8 Zn
13	323 5011	1	Lauftring	Race ring	D45/30x20,5
14	323 8301	1	Kassettendichtung	Sealing	RWDR 45x70x14 75 NBR 106200
15	455 0310	1	Achse	Axle	D30x95 M24x1,5 Zn
16	455 5145	1	Lagergehäuse	Bearing housing	D120/62x56,4/100 6xD10,2
17	301 3870	1	Sechskantschraube spz.	Hexagon bolt	M16x65-10.9 Zn
18	301 4603	1	Sechskantschraube spz.	Hexagon bolt	M20x75-8.8 Zn
22	303 1015	1	Sechskantmutter	Hexagon nut	M16 DIN934-8 Zn
25	317 3341	1	Einspannbuchse	Expansion bush	EG22/28x20-DIN1498
26	317 3352	1	Einspannbuchse mit Presssitz	Expansion bush	EG28/32x20
27	317 6657	1	Buchse	Bush	D20/28x22
28	317 6658	1	Buchse	Bush	D16/22x22

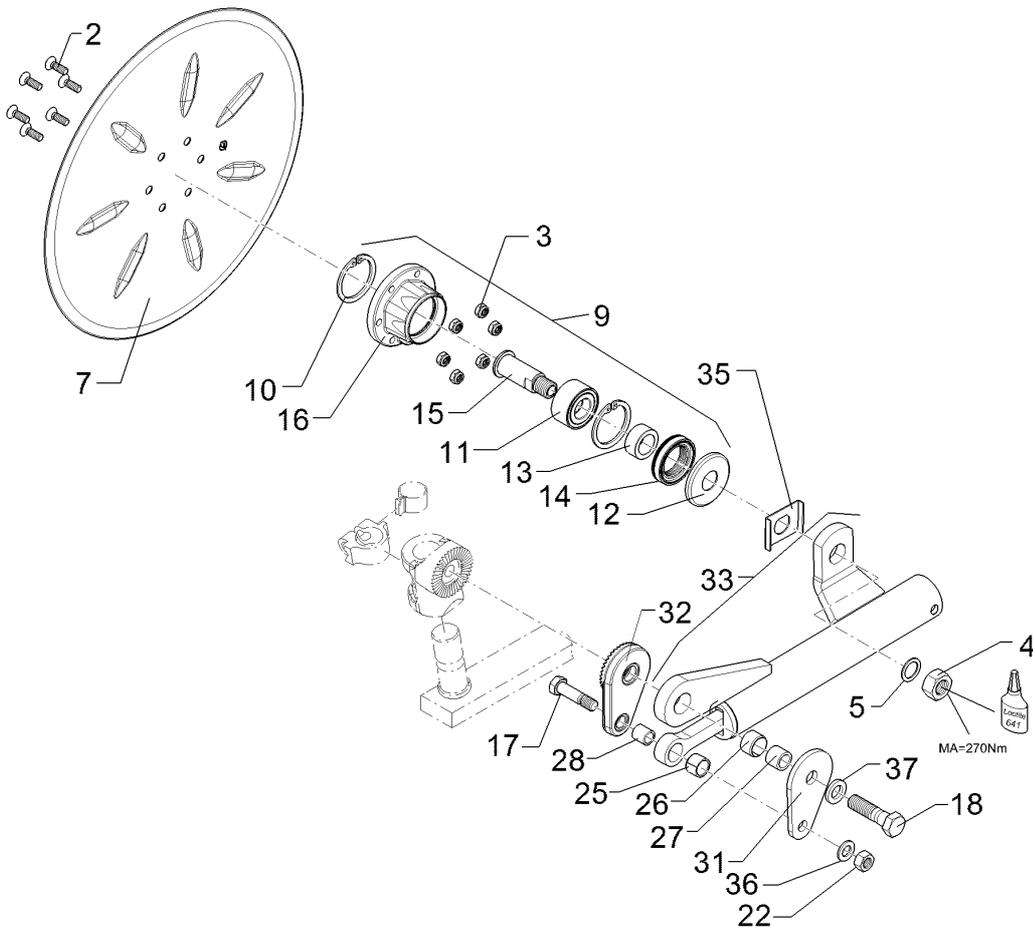

01.18

Pos.	Art.Nr.	Stck.	Artikeltext / Description	Abmessung	
31	457 9323	1	Platte	Plate	8x80x135 1xD20,5 1xD16,5
32	457 9324	1	Zahnkonsole	Hirth-type bracket	D77/20,5 40 Zähne
33	55710025	1	Federelement	Spring unit	55710025
35	305 1330	1	Verdrehsicherung	Locking	50x3x70 D30 Zn
36	305 6141	1	Scheibe	Washer	17/30x3 DIN/ISO-7089
37	305 6012	1	Scheibe	Washer	21 ISO7089 Zn

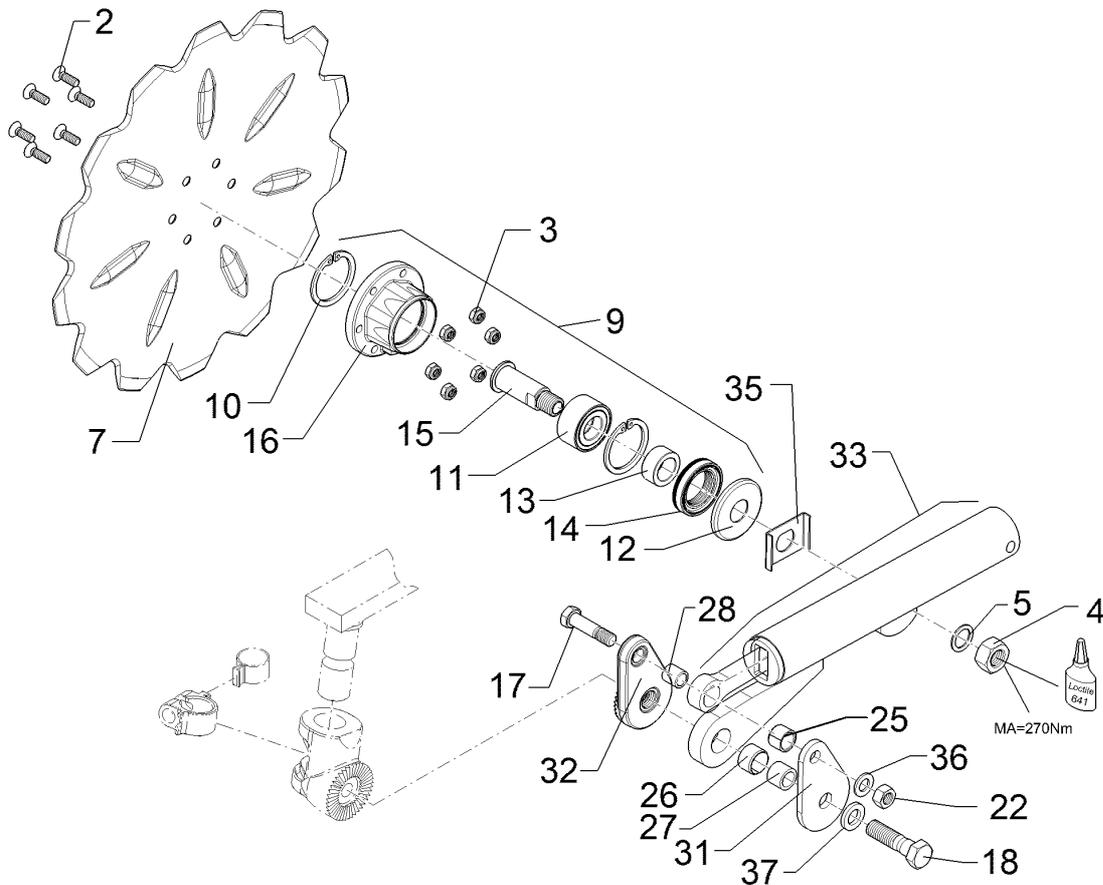

01.18

Pos.	Art.Nr.	Stck.	Artikeltext / Description	Abmessung	
1	305 8924	2	Sicherungsring	Retaining ring	62x2 DIN472
2	301 6123	6	Senkschraube	Countersunk bolt	M10x30-10.9 Zn DIN7991-A
3	303 0933	6	Sicherungsmutter	Selflocking nut	NM10-8 DIN985 Zn
4	303 0996	1	Sechskantmutter	Hexagon nut	M24x1,5 DIN934-8 Zn
5	305 2230	1	Stützscheibe	Supporting washer	S 25x35x2,0 DIN988 Zn
7	349 0050	1	Sechscheibe	Disc	D590/100x6 GEZ
9	555 4512	1	Lagereinheit	Bearing unit	30x120x100 M24x1,5
11	319 8760	1	Schrägkugellager doppelreihig	Bearing	30/62/30 RSR
12	323 0418	1	Schutzkappe	Cap	D79/75/30x8 Zn
13	323 5011	1	Lauftring	Race ring	D45/30x20,5
14	323 8301	1	Kassettendichtung	Sealing	RWDR 45x70x14 75 NBR 106200
15	455 0310	1	Achse	Axle	D30x95 M24x1,5 Zn
16	455 5145	1	Lagergehäuse	Bearing housing	D120/62x56,4/100 6xD10,2
17	301 3870	1	Sechskantschraube spz.	Hexagon bolt	M16x65-10.9 Zn
18	301 4603	1	Sechskantschraube spz.	Hexagon bolt	M20x75-8.8 Zn
22	303 1015	1	Sechskantmutter	Hexagon nut	M16 DIN934-8 Zn
25	317 3341	1	Einspannbuchse	Expansion bush	EG22/28x20-DIN1498
26	317 3352	1	Einspannbuchse mit Presssitz	Expansion bush	EG28/32x20
27	317 6657	1	Buchse	Bush	D20/28x22
28	317 6658	1	Buchse	Bush	D16/22x22

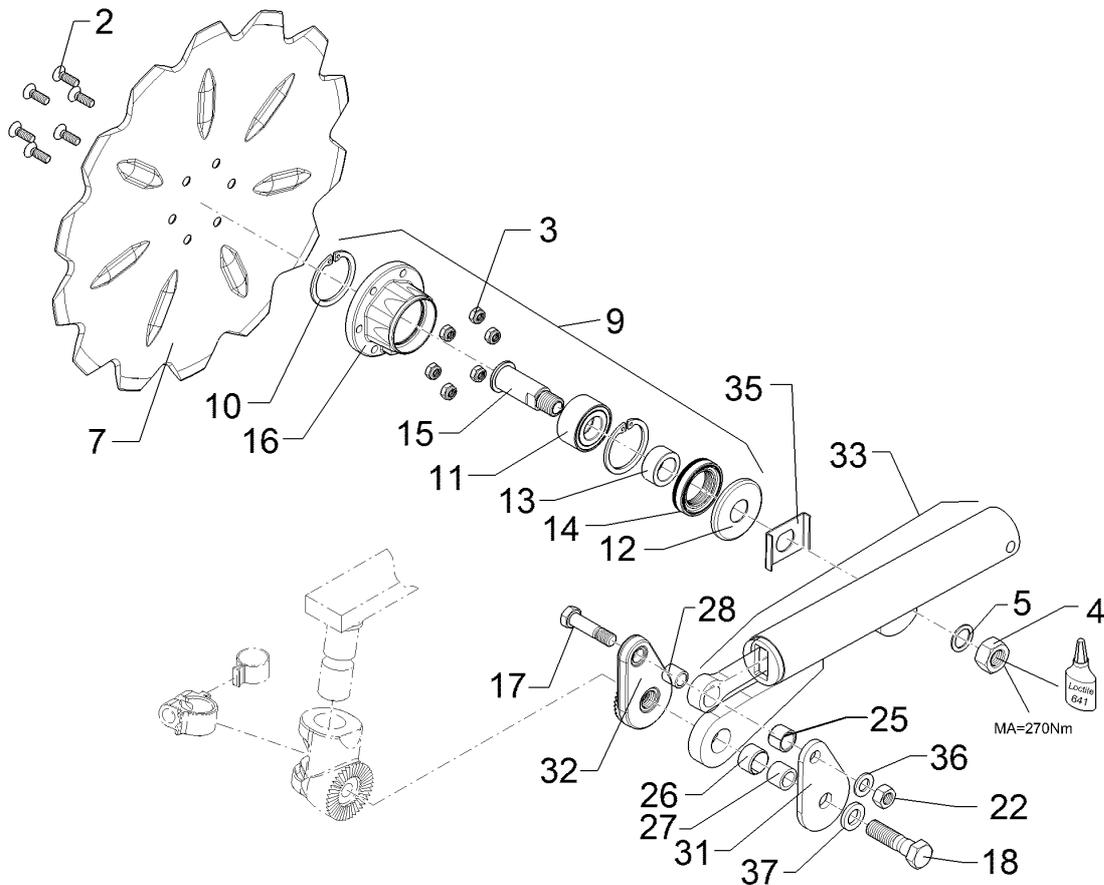

01.18

Pos.	Art.Nr.	Stck.	Artikeltext / Description		Abmessung
31	457 9323	1	Platte	Plate	8x80x135 1xD20,5 1xD16,5
32	457 9324	1	Zahnkonsole	Hirth-type bracket	D77/20,5 40 Zähne
33	55710024	1	Federelement	Spring unit	55710024
35	305 1330	1	Verdrehsicherung	Locking	50x3x70 D30 Zn
36	305 6141	1	Scheibe	Washer	17/30x3 DIN/ISO-7089
37	305 6012	1	Scheibe	Washer	21 ISO7089 Zn

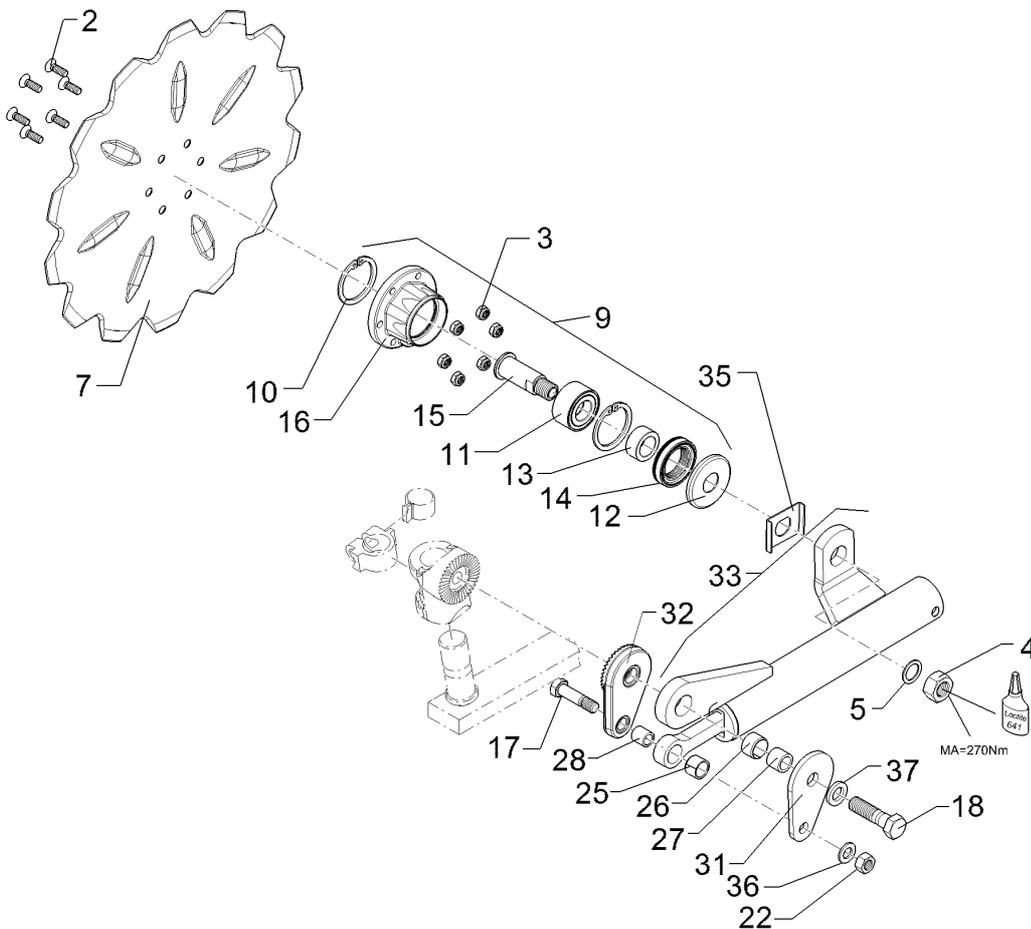

01.18

Pos.	Art.Nr.	Stck.	Artikeltext / Description		Abmessung
2	301 6123	6	Senkschraube	Countersunk bolt	M10x30-10.9 Zn DIN7991-A
3	303 0933	6	Sicherungsmutter	Selflocking nut	NM10-8 DIN985 Zn
4	303 0996	1	Sechskantmutter	Hexagon nut	M24x1,5 DIN934-8 Zn
5	305 2230	1	Stützscheibe	Supporting washer	S 25x35x2,0 DIN988 Zn
7	349 0050	1	Sechscheibe	Disc	D590/100x6 GEZ
9	555 4512	1	Lagereinheit	Bearing unit	30x120x100 M24x1,5
10	305 8924	2	Sicherungsring	Retaining ring	62x2 DIN472
11	319 8760	1	Schrägkugellager doppelreihig	Bearing	30/62/30 RSR
12	323 0418	1	Schutzkappe	Cap	D79/75/30x8 Zn
13	323 5011	1	Lauftring	Race ring	D45/30x20,5
14	323 8301	1	Kassettendichtung	Sealing	RWDR 45x70x14 75 NBR 106200
15	455 0310	1	Achse	Axle	D30x95 M24x1,5 Zn
16	455 5145	1	Lagergehäuse	Bearing housing	D120/62x56,4/100 6xD10,2
17	301 3870	1	Sechskantschraube spz.	Hexagon bolt	M16x65-10.9 Zn
18	301 4603	1	Sechskantschraube spz.	Hexagon bolt	M20x75-8.8 Zn
22	303 1015	1	Sechskantmutter	Hexagon nut	M16 DIN934-8 Zn
25	317 3341	1	Einspannbuchse	Expansion bush	EG22/28x20-DIN1498
26	317 3352	1	Einspannbuchse mit Presssitz	Expansion bush	EG28/32x20
27	317 6657	1	Buchse	Bush	D20/28x22
28	317 6658	1	Buchse	Bush	D16/22x22

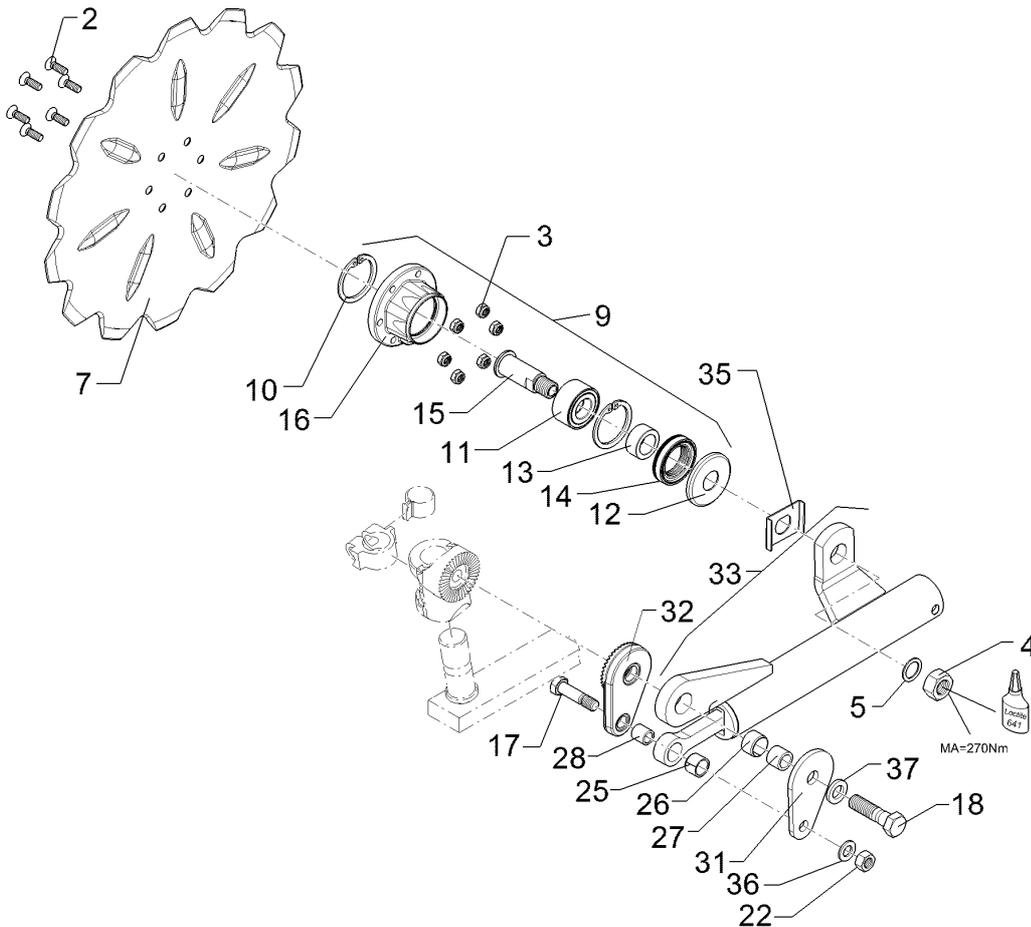

01.18

Pos.	Art.Nr.	Stck.	Artikeltext / Description		Abmessung
31	457 9323	1	Platte	Plate	8x80x135 1xD20,5 1xD16,5
32	457 9324	1	Zahnkonsole	Hirth-type bracket	D77/20,5 40 Zähne
33	55710025	1	Federelement	Spring unit	55710025
35	305 1330	1	Verdrehsicherung	Locking	50x3x70 D30 Zn
36	305 6141	1	Scheibe	Washer	17/30x3 DIN/ISO-7089
37	305 6012	1	Scheibe	Washer	21 ISO7089 Zn

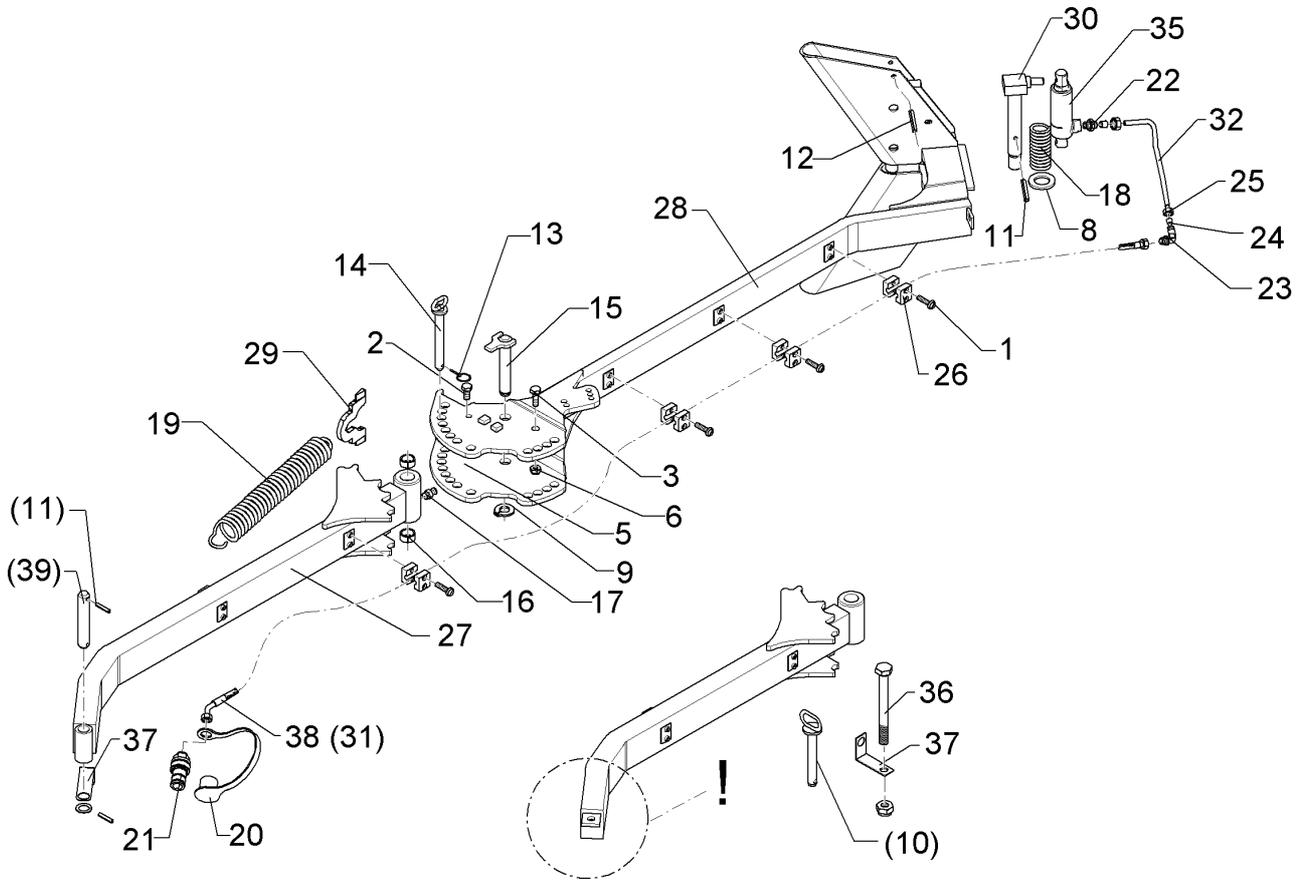

01.18

Pos.	Art.Nr.	Stck.	Artikeltext / Description		Abmessung
1	301 0302	10	Linsenschraube	Oval head screw	M6x25-4,6 Zn DIN7985
2	301 3314	1	Sechskantschraube	Hexagon bolt	M12x25-8.8 Zn DIN933
3	301 3701	1	Sechskantschraube	Hexagon bolt	M16x35-12.9 A=max.3 Zn DIN933
5	303 0934	1	Sicherungsmutter	Selflocking nut	NM12-8 Zn DIN985
6	303 0935	1	Sicherungsmutter	Selflocking nut	NM16-8 Zn DIN985
8	305 6229	1	Scheibe	Washer	45x31x5 Zn DIN1441
9	305 8861	1	Sicherungsring	Retaining ring	25x2 DIN471 Zn
10	313 8715	1	Bolzen mit Griff	Pin with grip	D16x116,75/135 Zn
11	309 6072	2	Spannhülse	Expansion bush	8x40-DIN1481 Zn
12	309 6174	2	Spannhülse	Expansion bush	10x70-DIN1481
13	311 9565	3	Klappstift	Securing pin	4,5
14	313 2020	2	Bolzen mit Griff	Pin with grip	D20x143/165 Zn
15	313 2538	1	Bolzen mit Verdrehsicherung	Pin with stop	D25x136/153 Zn
16	317 3408	2	Einspannbuchse mit Presssitz	Expansion bush	EG25/32x20
17	323 6348	1	Schmiernippel	Grease nipple	AM10x1 DIN71412
18	329 8289	1	Druckfeder	Compression spring	5x37x138
19	329 8595	1	Zugfeder	Spring	7x35x437
20	375 2164	1	Staubkappe	Dust cap	rd BG.2
21	375 2716	1	SVK-Stecker	Hydraulic coupling	BG-2 10LM16x1,5
22	375 3990	1	Einschraubverschraubung	Nipple	x-GE 10-LM M18x1,5
23	375 4390	1	Winkel-Schottverschraubung	Angle union	x-WSV10-L M16x1,5

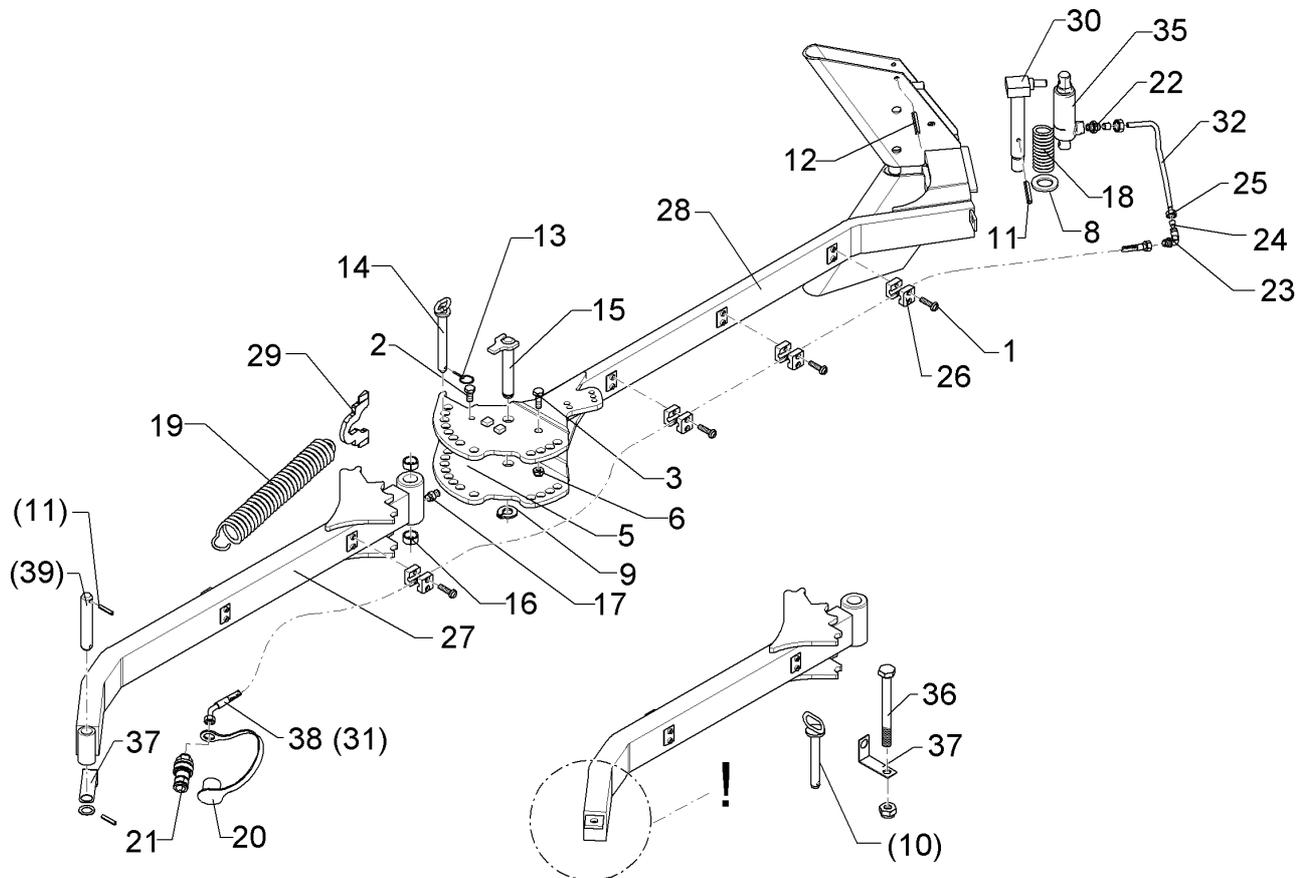

01.18

Pos.	Art.Nr.	Stck.	Artikeltext / Description		Abmessung
24	375 5100	2	Schneidring	Cutting ring	S 10 L WD
25	375 5300	2	Überwurfmutter	Union nut	10L M16x1,5 Zn
26	375 9961	10	Schellenkörper	Clamp	1/2x215 PP
27	422 9529	1	Mitnehmerarm	Attachment arm	Juwel 7/8 80x50x1255
28	422 9515	1	Fangarm	Hook arm	80x30 E2V
29	422 9516	1	Hebel	Lever	10x93x140
30	422 9550	1	Verriegelungsbolzen	Locking pin	D30x240 Zn
31	475 2677	1	Hydraulikschlauch	Hydraulic hose	1SN08-2200 DKOL10 0/45 GRD
32	57511111	1	Hydraulikrohr	Hydraulic tube	10x2x309 3xGEB
35	575 2328	1	Hydraulikzylinder	Hydraulic ram	ED30/35 D16/170
37	475 4423	1	Halter	Holder	2,5x30x175 1xGEB90GRD Zn
38	475 2700	1	Hydraulikschlauch	Hydraulic hose	1SN08-2400 DKOL10 0/45 GRD
39	31310001	1	Bolzen	Pin	D25x140 Zn

Schlauchpaket/Hose-assembly	10
Juwel 7M	47510308

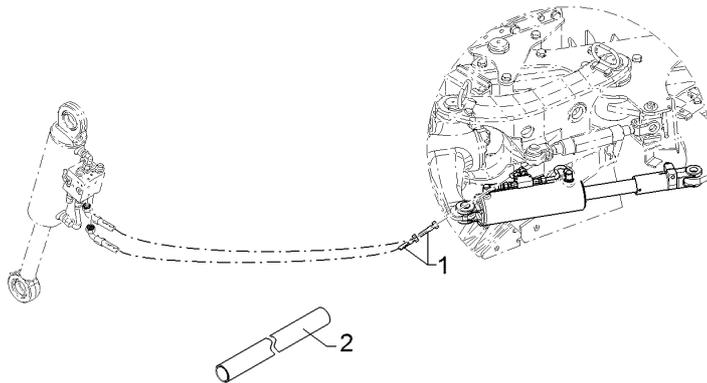

01.18

Pos.	Art.Nr.	Stck.	Artikeltext / Description		Abmessung
1	47510322	2	Hydraulikschlauch	Hydraulic hose	2SC08-2450 DKOL8/DKOL12
2	47510623	1	Schutzschlauch	Guard for hoses	0/45° Berst-Schutzschlauch di46x2100

Schlauchpaket/Hose-assembly	10
Juwel 7M	47510309

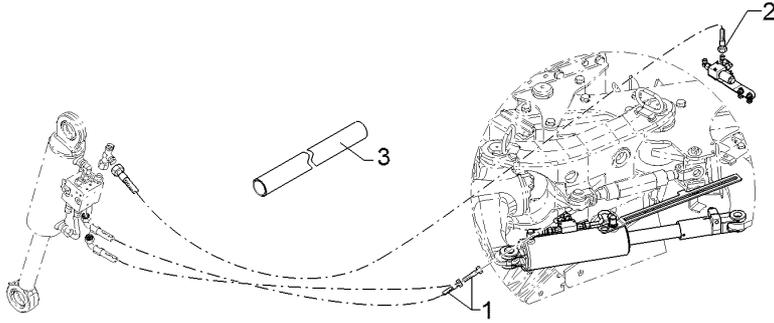

01.18

Pos.	Art.Nr.	Stck.	Artikeltext / Description		Abmessung
1	47510322	2	Hydraulikschlauch	Hydraulic hose	2SC08-2450 DKOL8/DKOL12 0/45°
2	47510323	1	Hydraulikschlauch	Hydraulic hose	MTH06-3300 DKOL10 0°/DKOL12 90
3	47510624	1	Schutzschlauch	Guard for hoses	Berst-Schutzschlauch di46x2400

Schlauchpaket/Hose-assembly	10
Juwel 7M	47510316

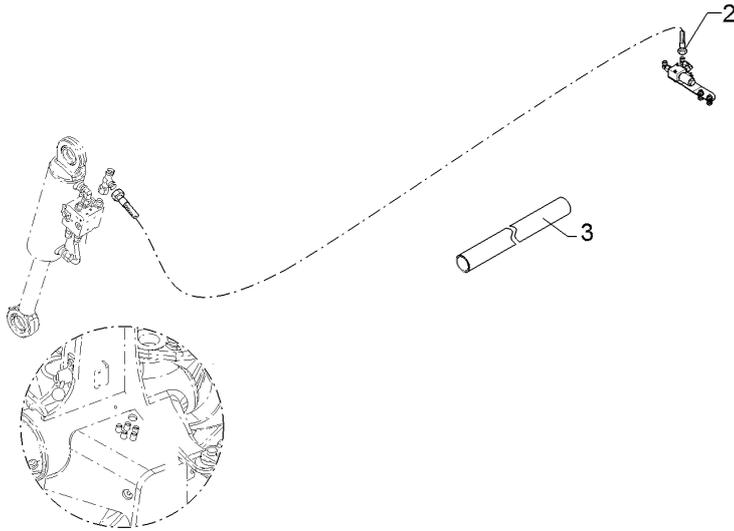

01.18

Pos.	Art.Nr.	Stck.	Artikeltext / Description		Abmessung
2	47510323	1	Hydraulikschlauch	Hydraulic hose	MTH06-3300 DKOL10 0°/DKOL12 90
3	47510627	1	Schutzschlauch	Guard for hoses	Berst-Schutzschlauch di27x3100

Schlauchpaket/Hose-assembly	10
Juwel 7M	47510563

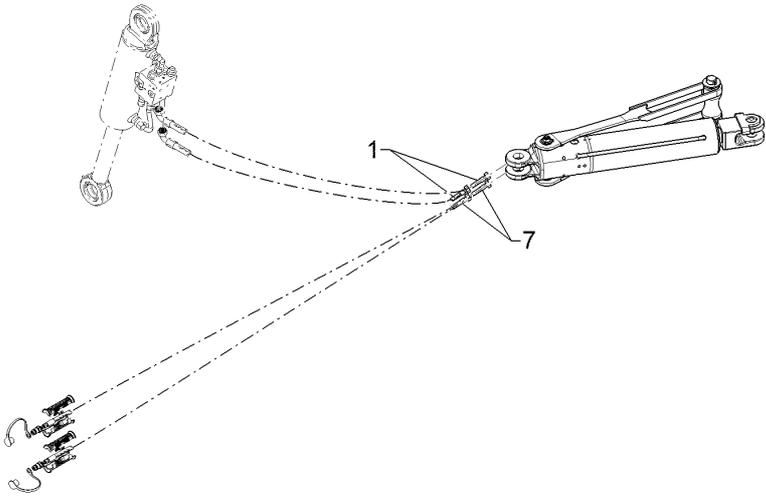

01.18

Pos.	Art.Nr.	Stck.	Artikeltext / Description		Abmessung
1	47510557	2	Hydraulikschlauch	Hydraulic hose	2SC08-2450 DKOL8/DKOL8 0/90° MTH06-4700 DKO L12/L08 00°/90°
7	47510536	2	Hydraulikschlauch	Hydraulic hose	

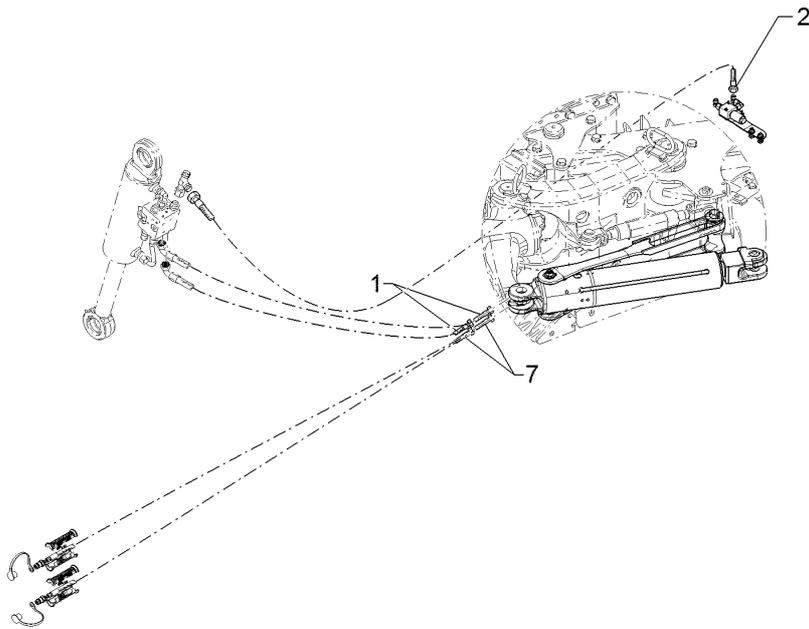

01.18

Pos.	Art.Nr.	Stck.	Artikeltext / Description		Abmessung
1	47510557	2	Hydraulikschlauch	Hydraulic hose	2SC08-2450 DKOL8/DKOL8 0/90°
2	47510323	1	Hydraulikschlauch	Hydraulic hose	MTH06-3300 DKOL10 0°/DKOL12 90
7	47510536	2	Hydraulikschlauch	Hydraulic hose	MTH06-4700 DKO L12/L08 00°/90°

Schlauchpaket/Hose-assembly	10
-----------------------------	----

Juwel 7M	47510567
----------	----------

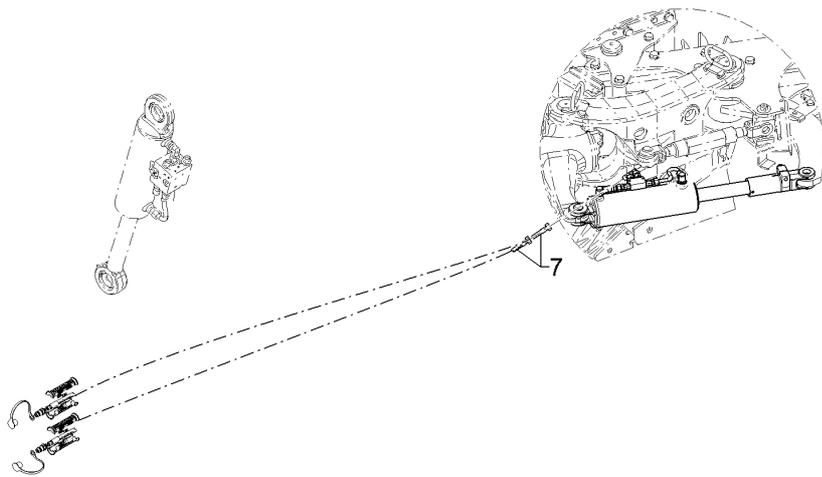

01.18

Pos.	Art.Nr.	Stck.	Artikeltext / Description		Abmessung
7	475 3544	2	Hydraulikschlauch	Hydraulic hose	MTH06-4700 DKOL12 00°/45°

Schlauchpaket/Hose-assembly	10
Juwel 7M	47510568

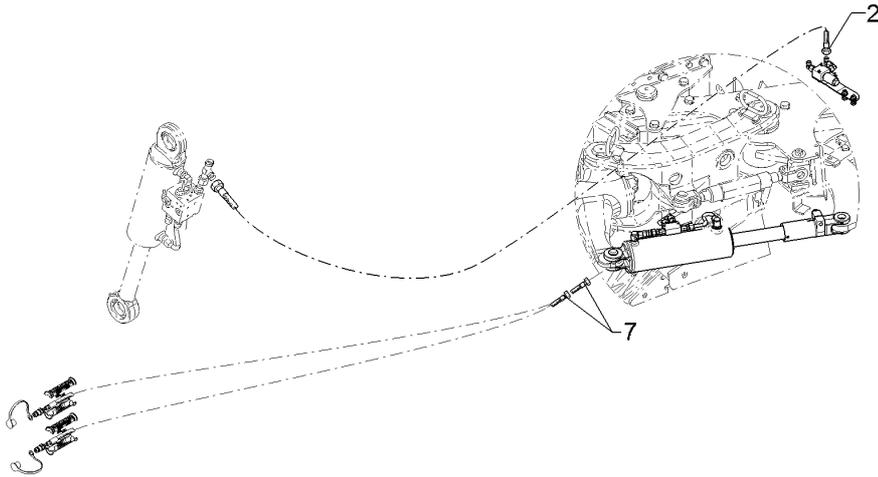

01.18

Pos.	Art.Nr.	Stck.	Artikeltext / Description		Abmessung
2	47510323	1	Hydraulikschlauch	Hydraulic hose	MTH06-3300 DKOL10 0°/DKOL12 90
7	475 3544	2	Hydraulikschlauch	Hydraulic hose	MTH06-4700 DKOL12 00°/45°

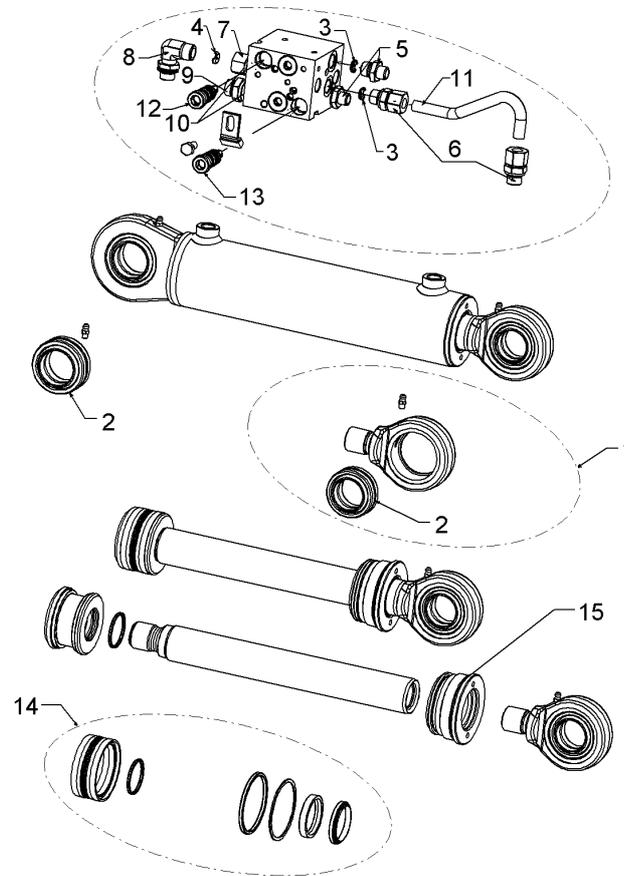

01.18

Pos.	Art.Nr.	Stck.	Artikeltext / Description		Abmessung
1	302 9108	1	Gelenkgabel	Fork-type joint	M27x1,5-55-D35
2	317 3454	2	Gelenklager	Articulated bearing	GE 35 DO
3	375 2509	2	Drosselscheibe Dreibein	Restrictor washer	1,7
4	375 2515	1	Drosselscheibe Dreibein	Restrictor washer	Dreibein 2,5
5	375 3983	2	Gerade Einschraubverschraubung	Nipple	x-GE 08-LM 16x1,5
6	375 4011	2	Einschraubverschraubung	Nipple	x-GE12-LM-ED
7	375 4041	1	Einschraubverschraubung	Nipple	M16x1,5 Zn evGE 12-LM M16x1,5 DKO24
8	375 4329	1	Schwenverschraubung	Union, swivel	GRD 812258.0 Weber
9	375 4726	2	Schraubstutzen	Nipple	M18x1,5/M18x1,5SW24x37
10	375 5081	2	Dichtkantenring	Seal ring	18,2x25,1x5
11	47510038	1	Hydraulikrohr	Hydraulic tube	12x2x244x131 GEB
12	575 2124	1	Rückschlagventil	Nonreturn valve	R 13 E 4 M
13	575 2164	1	Rückschlagventil	Nonreturn valve	R 13 E 4 M
14	575 9277	1	Dichtungssatz	Seal set	40/80

Dämpferzylinder/Ram 10

Juwel 7M 575 2577

69910159

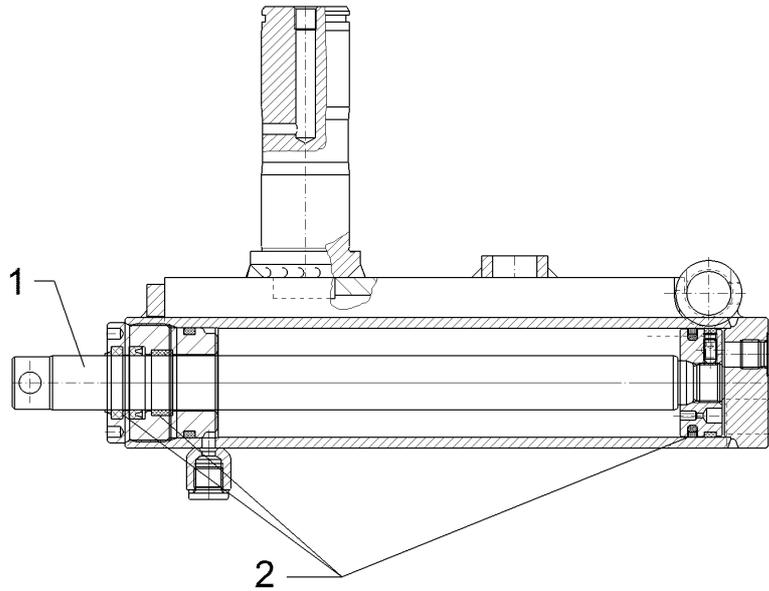

01.18

Pos.	Art.Nr.	Stck.	Artikeltext / Description		Abmessung
1	57510160	1	Kolbenstange	Piston rod	D25
2	57510951	1	Dichtungssatz	Seal set	25/50

Einschwenkzylinder/Swing-in ram	10
Juwel 7M	57510254

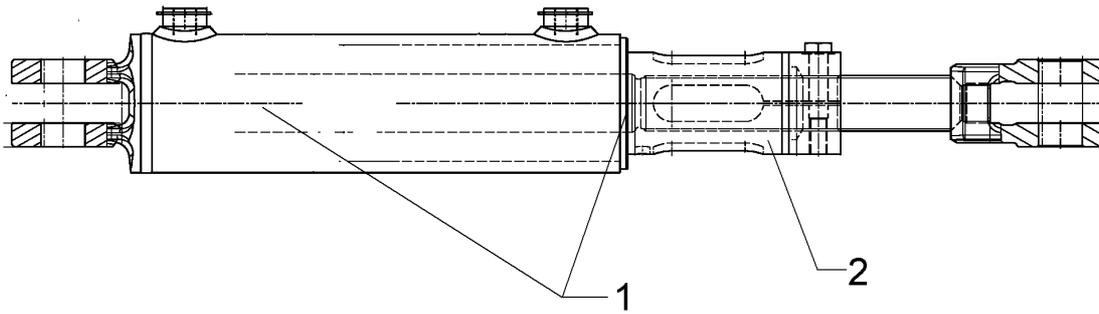

01.18

Pos.	Art.Nr.	Stck.	Artikeltext / Description		Abmessung
1	575 9279	1	Dichtungssatz	Seal set	45/90
2	47511075	1	Klemmhülse	Clamping bush	Hubverstellung Einschwenkzylin

Hydraulikzylinder/Hydraulic ram	10
Juwel 7M	57510525

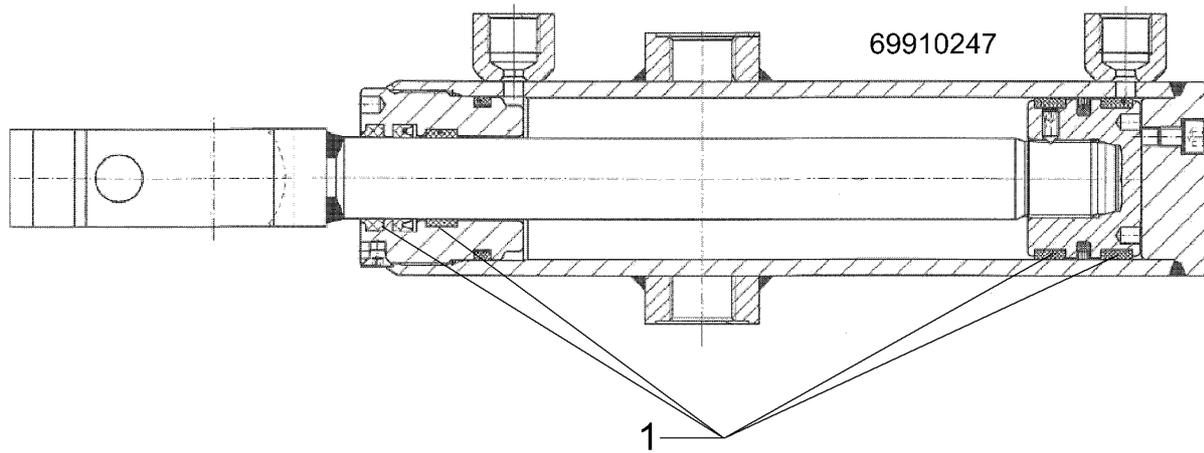

01.18

Pos.	Art.Nr.	Stck.	Artikeltext / Description		Abmessung
1	57510197	1	Dichtungssatz	Seal set	D50/25

Memoryzylinder/Memory ram	10
---------------------------	----

Juwel 7M	57510590
----------	----------

1

69910280

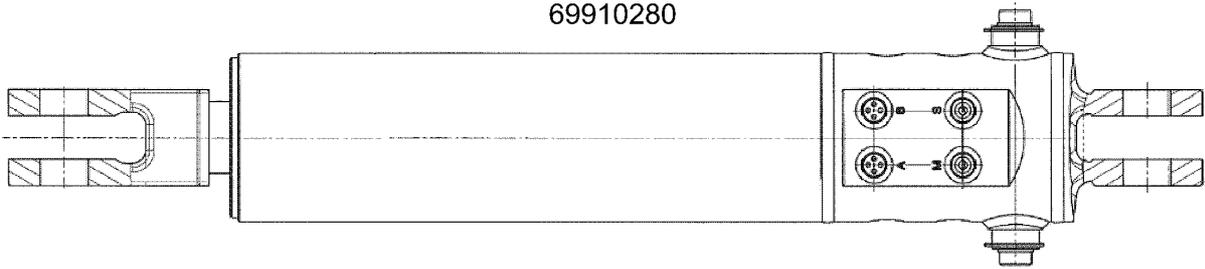

01.18

Pos.	Art.Nr.	Stck.	Artikeltext / Description		Abmessung
1	575 9283	1	Dichtungssatz	Seal set	45/90

Dämpferzylinder/Ram	10
Juwel 7M	57510679

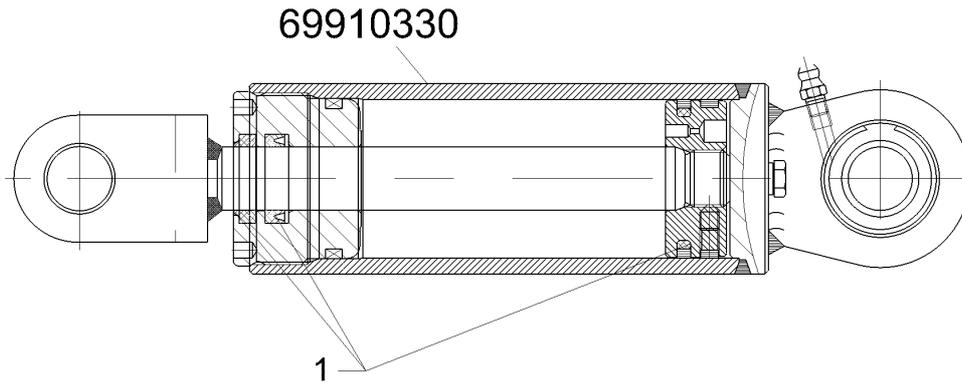

01.18

Pos.	Art.Nr.	Stck.	Artikeltext / Description		Abmessung
1	57510685	1	Dichtungssatz	Seal set	D20/50

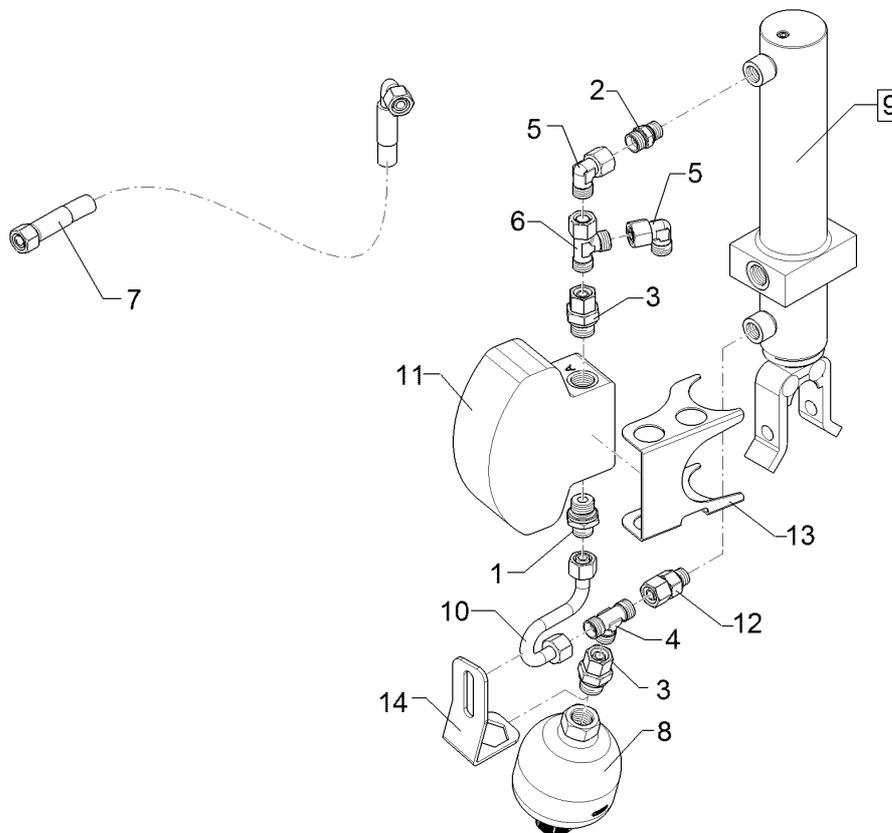

01.18

Pos.	Art.Nr.	Stck.	Artikeltext / Description		Abmessung
1	375 4058	1	Einschraubverschraubung	Nipple	GE 12-LR 1/2" ED
2	375 4010	2	Einschraubverschraubung	Nipple	x-GE12-LM M16x1,5 Zn
3	375 4049	2	Einstellbare GE-Verschraubung	Nipple	evGE 12-LR 1/2"-ED DKO
4	375 4480	1	T-Verschraubung	T-union	x-T12-L M18x1,5 Zn
5	375 4500	2	Einstellbare W-Verschraubung	Adjustable angle union	EW12-LM DKO24 GRD M18x1,5
6	375 4550	1	Einstellbare L-Verschraubung	Adjustable L-union	EL12-L M18x1,5
7	47510840	1	Schlauchpaket	Hose-assembly	Juwel 8M, St.-Zyl. Zul.
8	575 9055	1	Druckspeicher	Pressure accumulator	Typ 0,32l 210-003bar G1/2ZL
9	57510525	1	Hydraulikzylinder	Hydraulic ram	50/25-250-150
10	57510846	1	Hydraulikrohr	Hydraulic tube	12x2x198 2xGEB
11	57510852	1	Steuerventil	Control valve	110x65x145 2xG1/2
12	375 4041	1	Einschraubverschraubung	Nipple	evGE 12-LM M16x1,5 DKO24
13	47511192	1	Sicherungsblech	Locking plate	GRD 2x110x234,6 2xGEB

Hydraulikzylinder/Hydraulic ram	10
---------------------------------	----

Juwel 7M	57511086
----------	----------

1

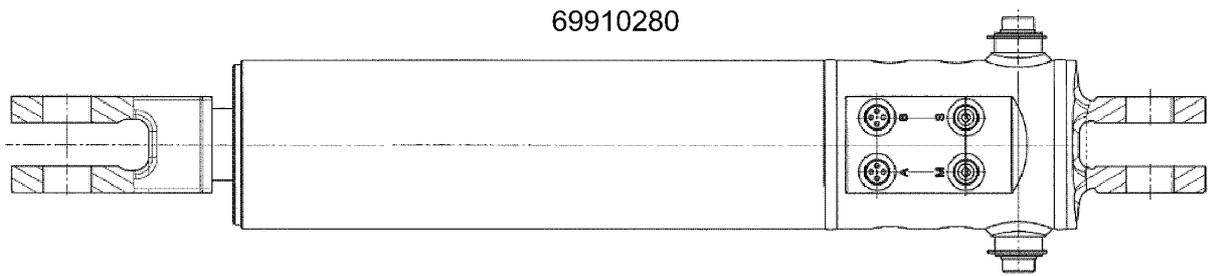

01.18

Pos.	Art.Nr.	Stck.	Artikeltext / Description		Abmessung
1	575 9283	1	Dichtungssatz	Seal set	45/90

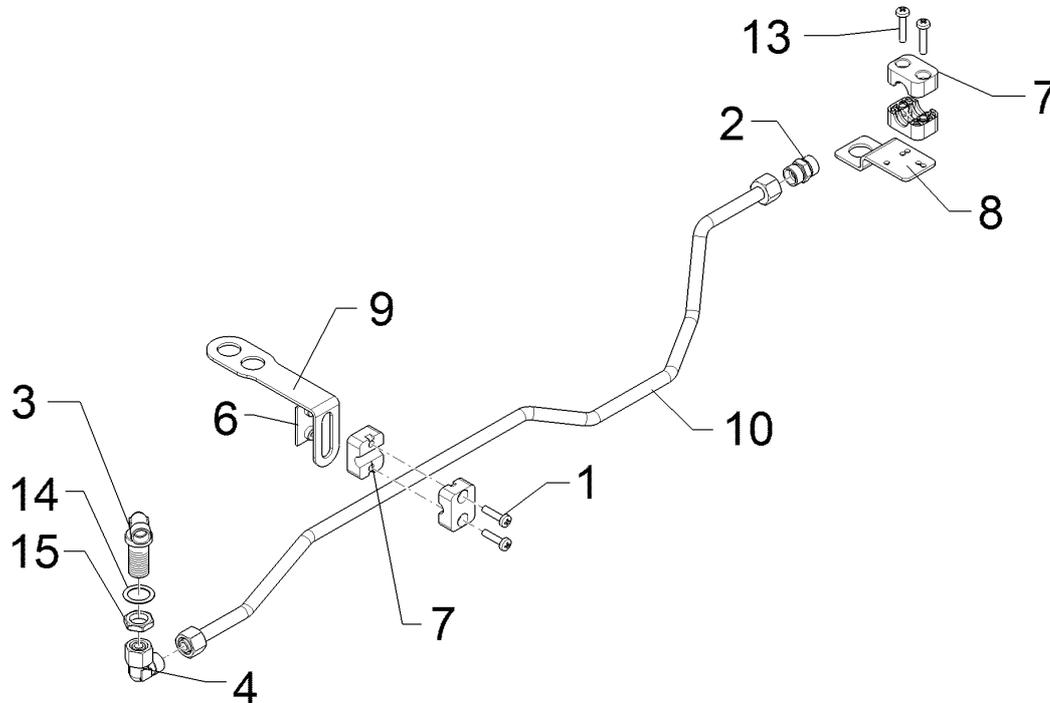

01.18

Pos.	Art.Nr.	Stck.	Artikeltext / Description		Abmessung
1	301 0302	2	Linsenschraube	Oval head screw	M6x25-4,6 Zn DIN7985
2	375 4110	1	Gerade Verschraubung	Nipple	x-G12-L M18x1,5
3	375 4400	1	Winkel-Schottverschraubung	Angle union	x-WSV12-L M18x1,5 Zn o.KM
4	375 4500	1	Einstellbare W-Verschraubung	Adjustable angle union	EW12-LM DKO24 GRD M18x1,5
6	37510137	1	Anschweißplatte	Weld on plate	SP2 42x30x2 Zn
7	37510138	4	Schellenkörper	Clamp	1/2x212 PP
8	475 4407	1	Halter	Holder	40x3x92 Zn
9	47511165	1	Halter	Holder	40x3x189,5 GEB 90GRD Zn
10	57511098	1	Hydraulikrohr	Hydraulic tube	12x2x850(787) 7xGEB
13	301 0303	2	Linsenschraube	Oval head screw	M6x30-4,6 Zn DIN7985
14	305 2228	1	Stützscheibe	Supporting washer	S 20x28x1,0 DIN988 Zn
15	375 5700	1	Mutter	Nut	M18x1,5 SW24x6

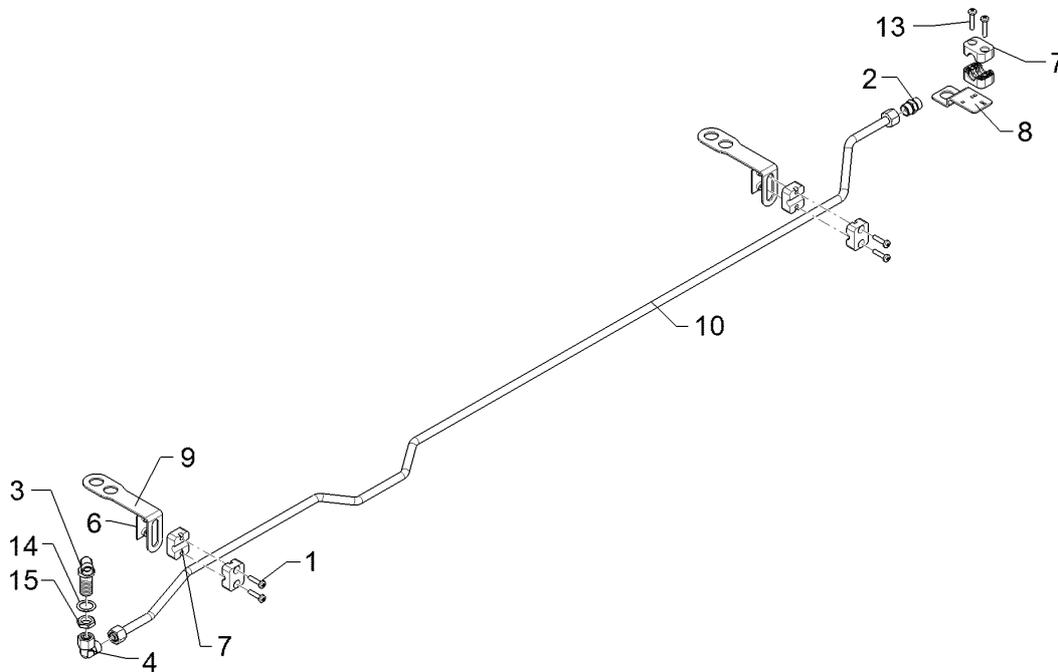

01.18

Pos.	Art.Nr.	Stck.	Artikeltext / Description		Abmessung
1	301 0302	4	Linsenschraube	Oval head screw	M6x25-4,6 Zn DIN7985
2	375 4110	1	Gerade Verschraubung	Nipple	x-G12-L M18x1,5
3	375 4400	1	Winkel-Schottverschraubung	Angle union	x-WSV12-L M18x1,5 Zn o.KM
4	375 4500	1	Einstellbare W-Verschraubung	Adjustable angle union	EW12-LM DKO24 GRD M18x1,5
6	37510137	2	Anschweißplatte	Weld on plate	SP2 42x30x2 Zn
7	37510138	6	Schellenkörper	Clamp	1/2x212 PP
8	475 4407	1	Halter	Holder	40x3x92 Zn
9	47511165	2	Halter	Holder	40x3x189,5 GEB 90GRD Zn
10	57511099	1	Hydraulikrohr	Hydraulic tube	12x2x1749(1687) 8xGEB
13	301 0303	2	Linsenschraube	Oval head screw	M6x30-4,6 Zn DIN7985
14	305 2228	1	Stützscheibe	Supporting washer	S 20x28x1,0 DIN988 Zn
15	375 5700	1	Mutter	Nut	M18x1,5 SW24x6

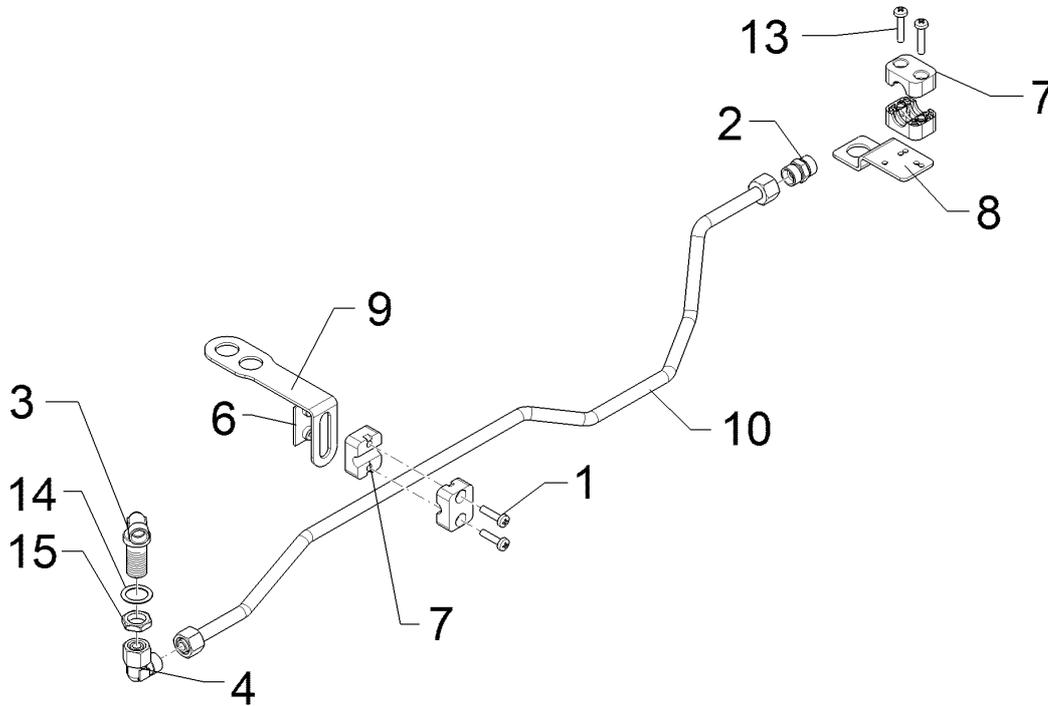

01.18

Pos.	Art.Nr.	Stck.	Artikeltext / Description		Abmessung
1	301 0302	2	Linsenschraube	Oval head screw	M6x25-4,6 Zn DIN7985
2	375 4110	1	Gerade Verschraubung	Nipple	x-G12-L M18x1,5
3	375 4400	1	Winkel-Schottverschraubung	Angle union	x-WSV12-L M18x1,5 Zn o.KM
4	375 4500	1	Einstellbare W-Verschraubung	Adjustable angle union	EW12-LM DKO24 GRD M18x1,5
6	37510137	1	Anschweißplatte	Weld on plate	SP2 42x30x2 Zn
7	37510138	4	Schellenkörper	Clamp	1/2x212 PP
8	475 4407	1	Halter	Holder	40x3x92 Zn
9	47511165	1	Halter	Holder	40x3x189,5 GEB 90GRD Zn
10	57511100	1	Hydraulikrohr	Hydraulic tube	12x2x950(887) 7xGEB
13	301 0303	2	Linsenschraube	Oval head screw	M6x30-4,6 Zn DIN7985
14	305 2228	1	Stützscheibe	Supporting washer	S 20x28x1,0 DIN988 Zn
15	375 5700	1	Mutter	Nut	M18x1,5 SW24x6

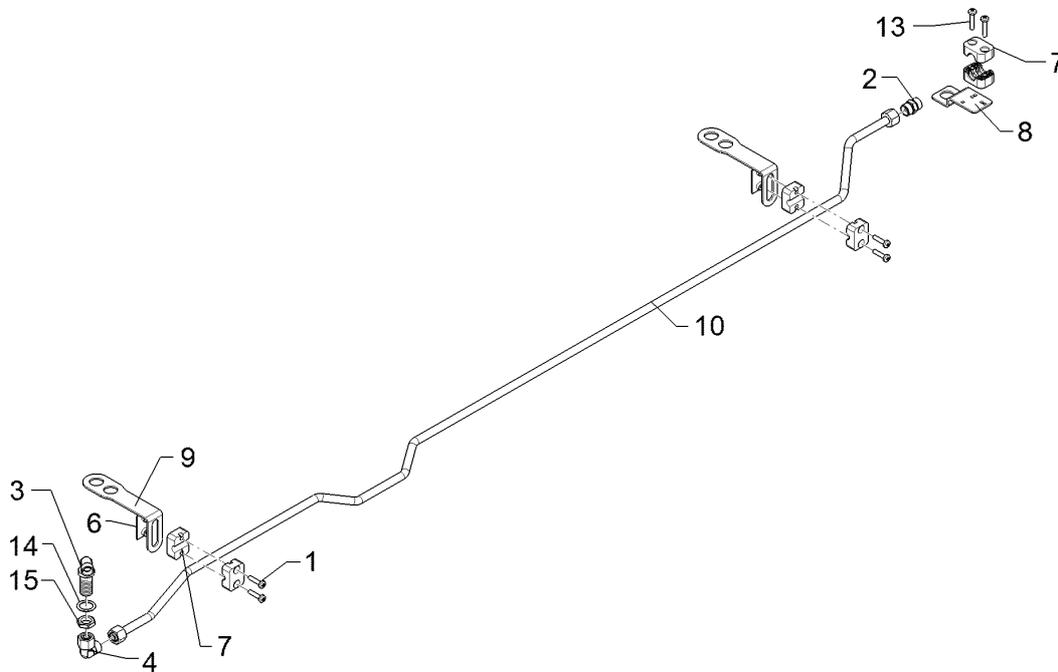

01.18

Pos.	Art.Nr.	Stck.	Artikeltext / Description		Abmessung
1	301 0302	4	Linsenschraube	Oval head screw	M6x25-4,6 Zn DIN7985
2	375 4110	1	Gerade Verschraubung	Nipple	x-G12-L M18x1,5
3	375 4400	1	Winkel-Schottverschraubung	Angle union	x-WSV12-L M18x1,5 Zn o.KM
4	375 4500	1	Einstellbare W-Verschraubung	Adjustable angle union	EW12-LM DKO24 GRD M18x1,5
6	37510137	2	Anschweißplatte	Weld on plate	SP2 42x30x2 Zn
7	37510138	6	Schellenkörper	Clamp	1/2x212 PP
8	475 4407	1	Halter	Holder	40x3x92 Zn
9	47511165	2	Halter	Holder	40x3x189,5 GEB 90GRD Zn
10	57511101	1	Hydraulikrohr	Hydraulic tube	12x2x1949(1887) 8xGEB
13	301 0303	2	Linsenschraube	Oval head screw	M6x30-4,6 Zn DIN7985
14	305 2228	1	Stützscheibe	Supporting washer	S 20x28x1,0 DIN988 Zn
15	375 5700	1	Mutter	Nut	M18x1,5 SW24x6

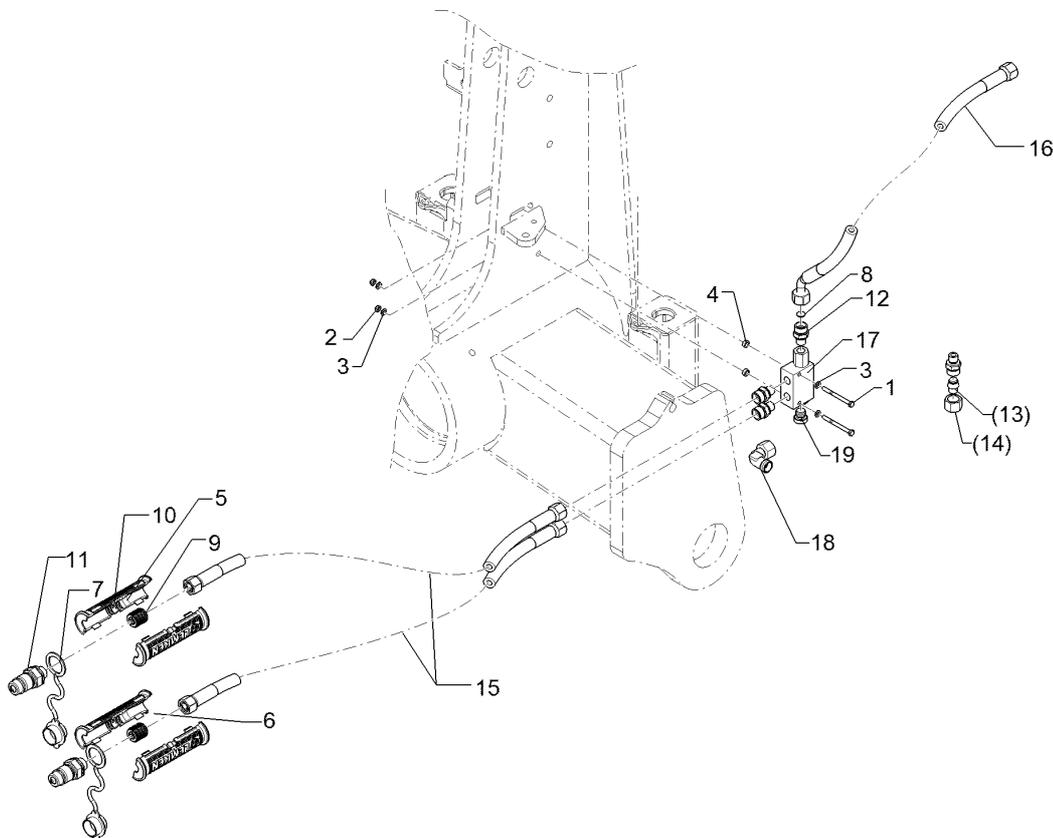

01.18

Pos.	Art.Nr.	Stck.	Artikeltext / Description		Abmessung
1	301 0370	2	Sechskantschraube	Hexagon bolt	M5x45-8.8 Zn DIN931
2	303 0929	2	Sicherungsmutter	Selflocking nut	NM5-8 Zn DIN985
3	305 8569	2	Scheibe	Washer	5,3 DIN125 Zn
4	31710123	2	Distanzbuchse	Distance bush	D10/6,2x4
5	325 1603	2	Kennzeichnung	Marking	P3
6	325 1610	2	Kennzeichnung	Marking	T3
7	375 2121	2	Staubkappe	Dust cap	D26,5 Bg.3
8	375 2172	1	Drosselscheibe	Restrictor washer	D12x1,5 BO 1,0
9	375 2606	2	Einleger	Insert	DN6 DN8
10	375 2607	4	Griff Halbschale	Handle	-
11	375 2718	2	SVK-Stecker	Hydraulic coupling	BG-3 12L M18x1,5
12	375 4038	3	Einschraubverschraubung	Nipple	GE 12-LR 1/4 ZL ED
13	375 4660	1	Blindstopfen	Blind plug	BUZ12-L
14	375 5310	1	Überwurfmutter	Union nut	12L M18x1,5 Zn/ZnNi
15	47510832	1	Schlauchpaket	Hose-assembly	Juwel 8M, St. P/T-Zul.
16	47511193	1	Schlauchpaket	Hose-assembly	Juwel 7M L, St
17	57510580	1	Rückschlagventil	Nonreturn valve	RPI 06/15-G
18	375 4500	2	Einstellbare W-Verschraubung	Adjustable angle union	EW12-LM DKO24 GRD M18x1,5
19	375 5158	1	Verschlusschraube	Plug	VSTI G 1/4Z

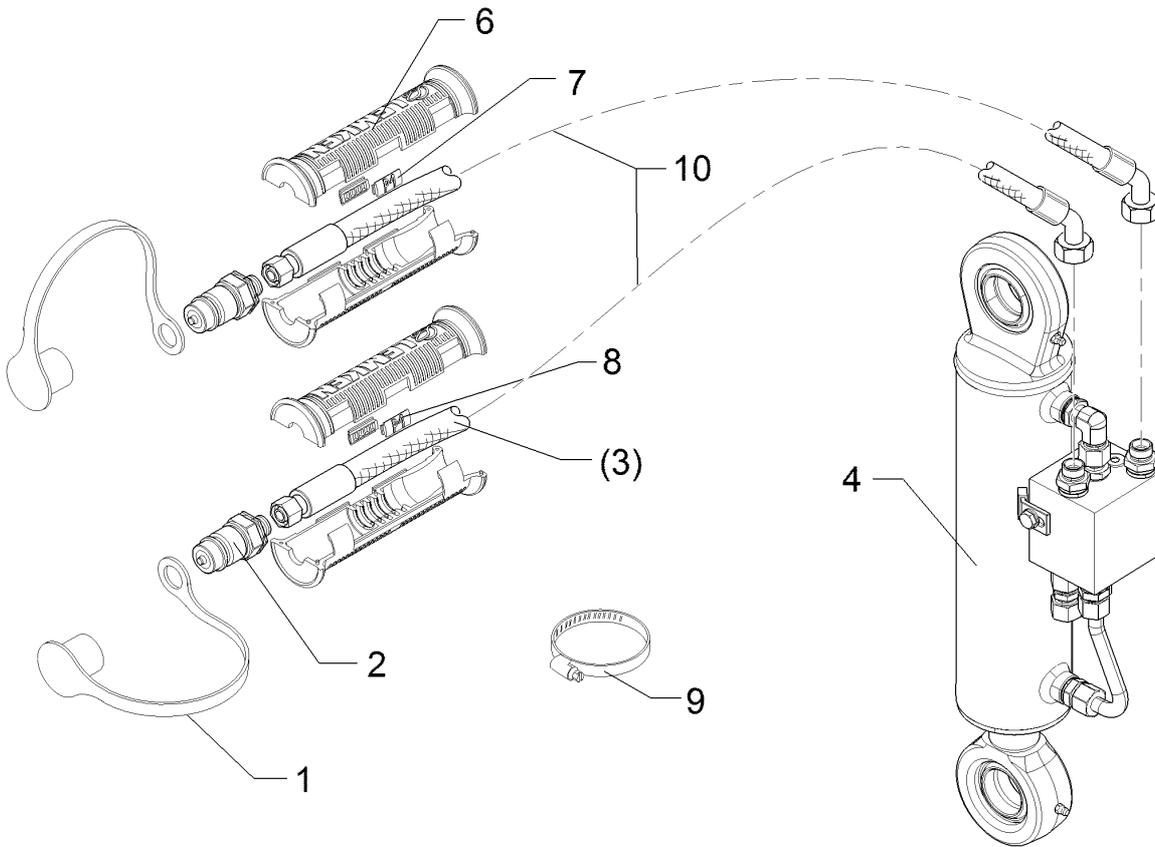

01.18

Pos.	Art.Nr.	Stck.	Artikeltext / Description	Abmessung
1	375 2166	2	Staubkappe, rot	Cap, red
2	375 2718	2	SVK-Stecker	Hydraulic coupling
3	475 3127	2	Hydraulikschlauch	Hydraulic hose
4	575 2506	1	Umschaltzylinder	Change over ram
6	375 2607	4	Griff Halbschale	Handle
7	325 1601	2	Kennzeichnung	Marking
8	325 1608	2	Kennzeichnung	Marking
9	325 1181	2	Schlauchklemme	Hose clamp
10	47510847	1	Schlauchpaket	Hose-assembly
				D26,5 BG-3 12L M18x1,5 2SN08-1950 DKOL12/DKOL12 DZ80/40-236-D35 HPS-III-AR - P1 20x9 T1 20x9 TORRO 90-110/12-C7W4 Juwel 8M,Dr.Zyl. P/T-Zul.(Komf

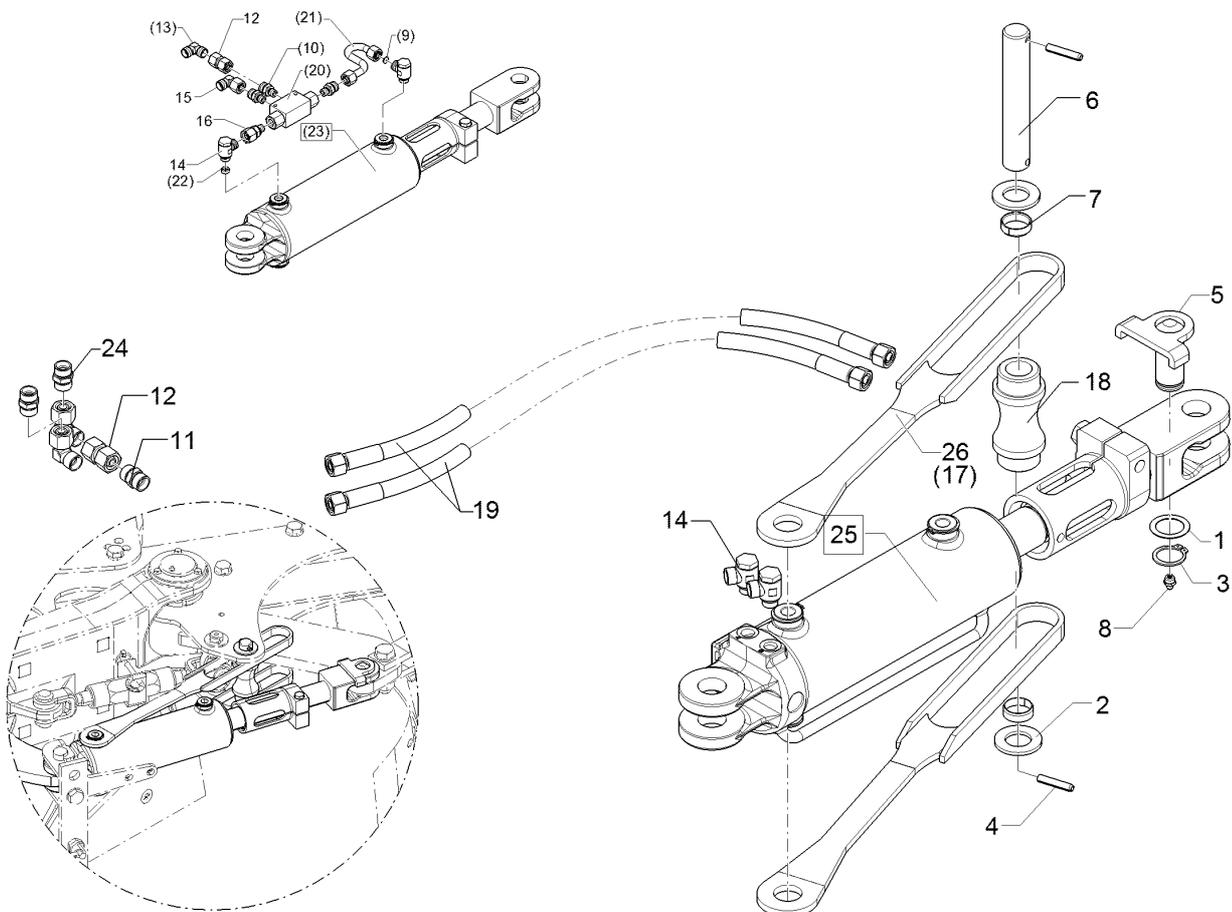

01.18

Pos.	Art.Nr.	Stck.	Artikeltext / Description		Abmessung
1	305 2051	1	Passscheibe	Shim	30x42x1,0 DIN988 Zn
2	305 6283	2	Scheibe	Washer	B28 DIN125
3	305 8867	1	Sicherungsring	Retaining ring	30x2 DIN471 Zn
4	309 6072	2	Spannhülse	Expansion bush	8x40-DIN1481 Zn
5	31310060	1	Bolzen	Pin	D30/61x69 U-71 Zn
6	31310074	1	Bolzen	Pin	D28x175 2xd8 V Zn
7	317 3347	2	Einspannbuchse mit Presssitz	Expansion bush	EG28/32x10
8	323 6348	1	Schmiernippel	Grease nipple	AM10x1 DIN71412
9	375 2214	1	Drosselscheibe	Restrictor washer	D12x1,5 BO 2,0
10	375 4038	3	Einschraubverschraubung	Nipple	GE 12-LR 1/4 ZL ED
11	375 4110	1	Gerade Verschraubung	Nipple	x-G12-L M18x1,5
12	375 4132	1	Verbindung gerade	Connection	DKOL12/DKOL12 M18x1,5
13	375 4210	1	Winkelverschraubung	Elbow union	x-W12-L M18x1,5
14	375 4310	2	Schwenkverschraubung	Union, swivel	x-SWVE12-LM M16x1,5
15	375 4500	2	Einstellbare W-Verschraubung	Adjustable angle union	EW12-LM DKO24 GRD M18x1,5
16	375 4711	1	Stutzen	Stud	x-evGE-12-ED 1/4" DKO 24 GRD
17	40210037	2	Begrenzungsstange	Outer rod	26x65x607 Zn
18	40210044	1	Distanzrohr	Distance tube	D55/45/28x119,5 V Zn
19	47511141	1	Schlauchpaket	Hose-assembly	Juwel 7M Ra

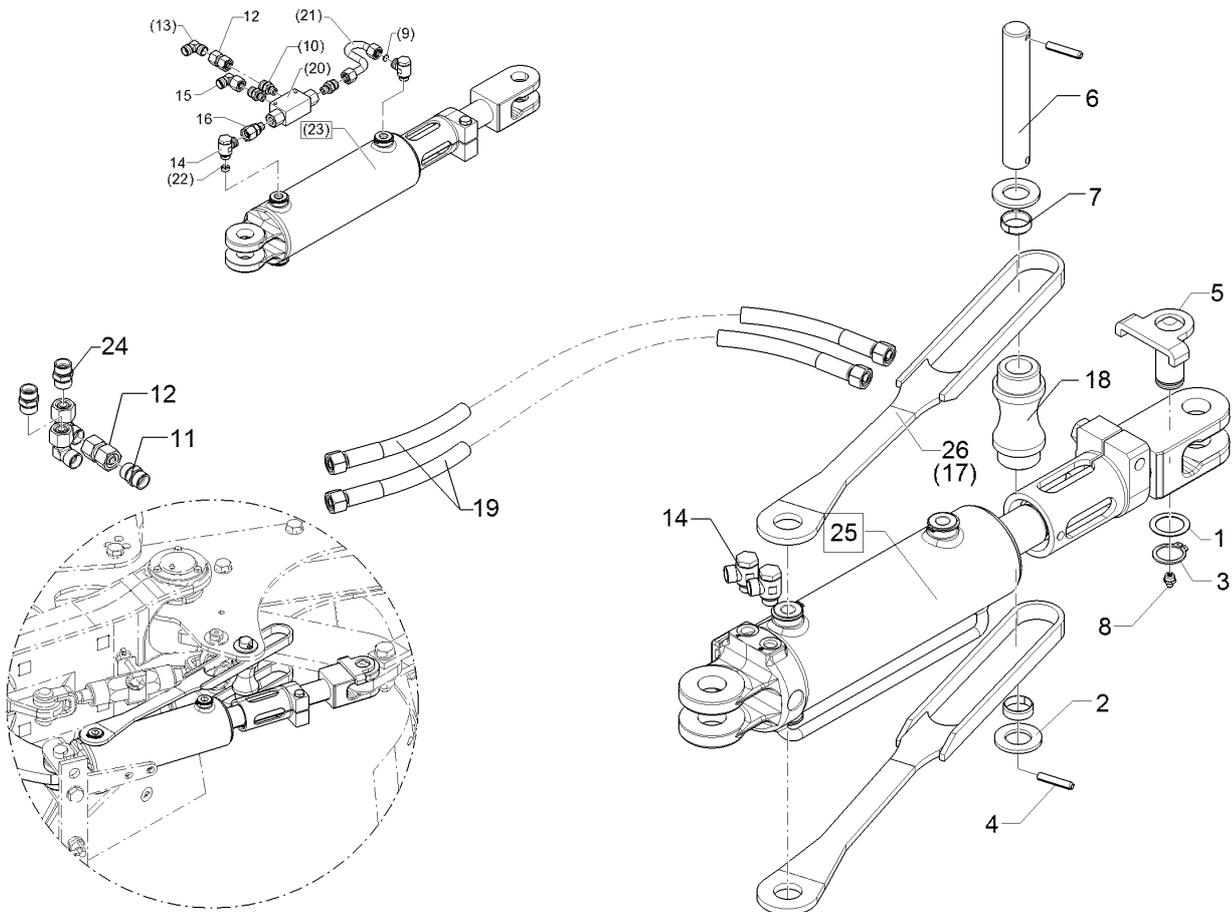

01.18

Pos.	Art.Nr.	Stck.	Artikeltext / Description	Abmessung	
20	57510037	1	Dopp.Rückschv.hy.ent.	Nonreturn valve	DVVG-G1/4 Q=15 l/min
21	57510203	1	Rohr 12x189 2xGEB 1xfürDrossel	Tube	12x2x189 2xGEB
22	57510207	1	Drosselrückschlagventil	Throttle nonreturn valve	1xDR
23	57510254	1	Einschwenkzylinder	Swing-in ram	D14,3/2,0
24	375 4010	2	Einschraubverschraubung	Nipple	DZ90/45x220/680
25	57511084	1	Hydraulikzylinder	Hydraulic ram	D30
26	40210110	2	Begrenzungsstange	Outer rod	x-GE12-LM M16x1,5 Zn
					DZ090/45x0220-0660
					D30 D30
					26x65x543 Zn

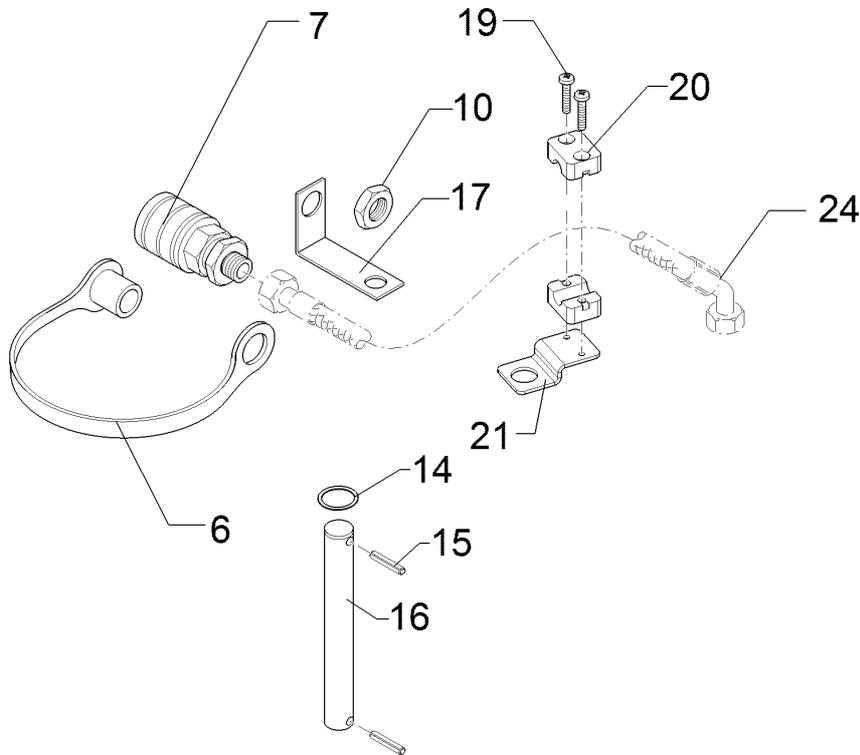

01.18

Pos.	Art.Nr.	Stck.	Artikeltext / Description		Abmessung
6	375 2163	1	Staubstecker	Plastic male probe	NW 6
7	375 2730	1	SVK-Muffe	SVK-socket	BG 2 NW8 M16x1,5 Schott
10	375 5698	1	Sechskantmutter	Hexagon nut	M16x1,5 SW22 Zn
14	305 2230	2	Stützscheibe	Supporting washer	S 25x35x2,0 DIN988 Zn
15	309 6072	2	Spannhülse	Expansion bush	8x40-DIN1481 Zn
16	31310001	1	Bolzen	Pin	D25x140 Zn
17	475 4423	1	Halter	Holder	2,5x30x175
19	301 0303	2	Linsenschraube	Oval head screw	1xGEB90GRD Zn M6x30-4,6 Zn DIN7985
20	375 9961	2	Schellenkörper	Clamp	1/2x215 PP
21	475 4407	1	Halter	Holder	40x3x92 Zn
22	325 1181	1	Schlauchklemme	Hose clamp	TORRO
23	375 4550	1	Einstellbare L-Verschraubung	Adjustable L-union	90-110/12-C7W4
24	47511142	1	Schlauchpaket	Hose-assembly	EL12-L M18x1,5 Juwel 7M Pa

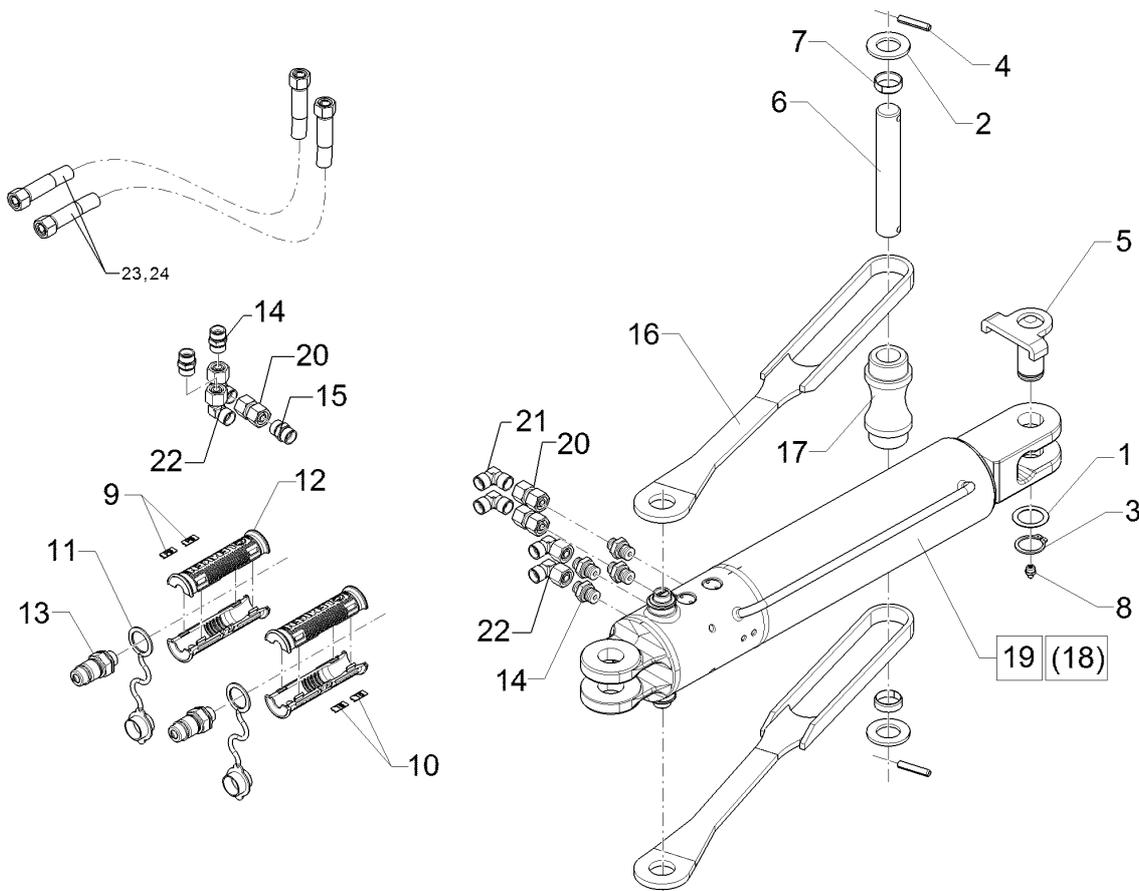

01.18

Pos.	Art.Nr.	Stck.	Artikeltext / Description		Abmessung
1	305 2051	1	Passscheibe	Shim	30x42x1,0 DIN988 Zn
2	305 6283	2	Scheibe	Washer	B28 DIN125
3	305 8867	1	Sicherungsring	Retaining ring	30x2 DIN471 Zn
4	309 6072	2	Spannhülse	Expansion bush	8x40-DIN1481 Zn
5	31310060	1	Bolzen	Pin	D30/61x69 U-71 Zn
6	31310074	1	Bolzen	Pin	D28x175 2xd8 V Zn
7	317 3347	2	Einspannbuchse mit Presssitz	Expansion bush	EG28/32x10
8	323 6348	1	Schmiernippel	Grease nipple	AM10x1 DIN71412
9	325 1606	2	Kennzeichnung	Marking	P6
10	325 1613	2	Kennzeichnung	Marking	T6
11	375 2123	2	Staubkappe, gelb	Cap	D26,5 Bg.3
12	375 2607	4	Griff Halbschale	Handle	-
13	375 2718	2	SVK-Stecker	Hydraulic coupling	BG-3 12L M18x1,5
14	375 4010	6	Einschraubverschraubung	Nipple	x-GE12-LM M16x1,5 Zn
15	375 4110	1	Gerade Verschraubung	Nipple	x-G12-L M18x1,5
16	40210037	2	Begrenzungsstange	Outer rod	26x65x607 Zn
17	40210044	1	Distanzrohr	Distance tube	D55/45/28x119,5 V Zn
18	57510590	1	Memoryzylinder	Memory ram	ME-90/45x220/680
19	57511086	1	Hydraulikzylinder	Hydraulic ram	ME090/45x0220-0660
20	375 4132	3	Verbindung gerade	Connection	D30 D30 DKOL12/DKOL12 M18x1,5

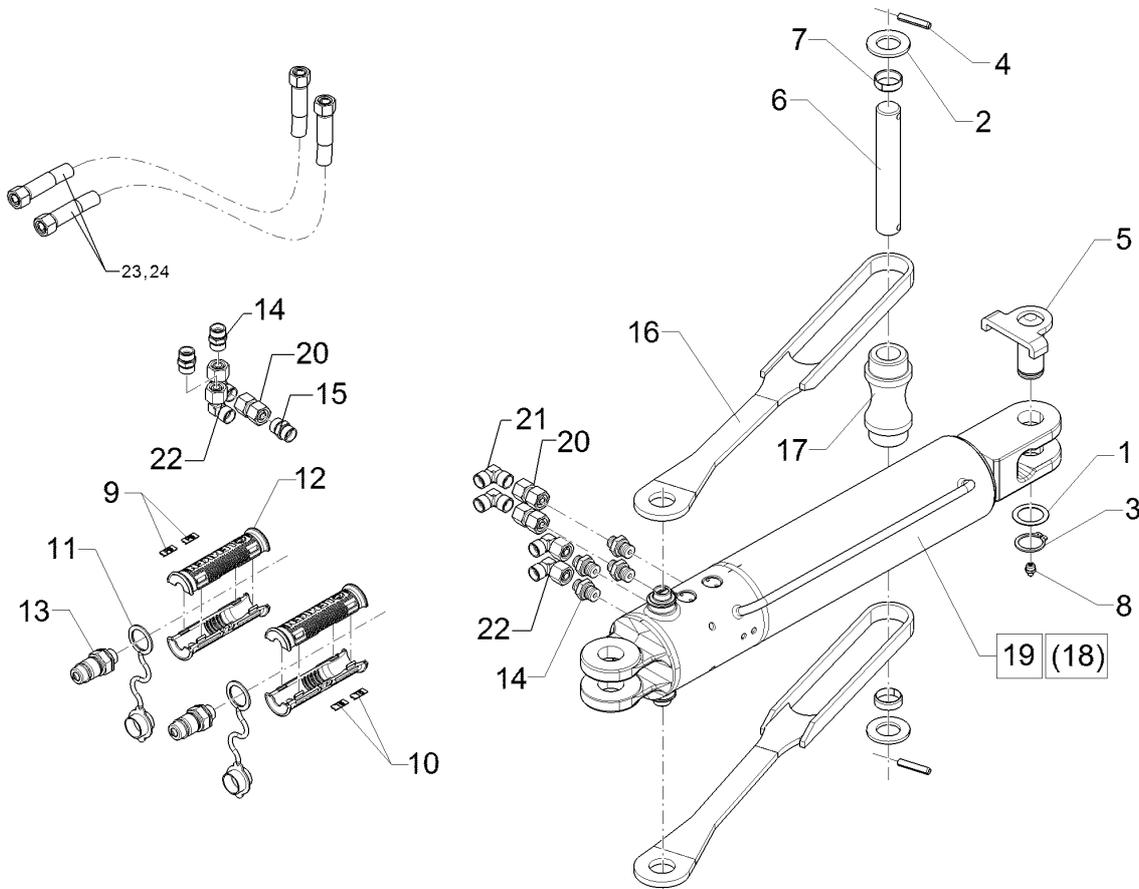

01.18

Pos.	Art.Nr.	Stck.	Artikeltext / Description		Abmessung
21	375 4210	2	Winkelverschraubung	Elbow union	x-W12-L M18x1,5
22	375 4500	4	Einstellbare W-Verschraubung	Adjustable angle union	EW12-LM DKO24 GRD M18x1,5
23	47511141	1	Schlauchpaket	Hose-assembly	Juwel 7M Ra
24	47511143	1	Schlauchpaket	Hose-assembly	Juwel 7M Vf

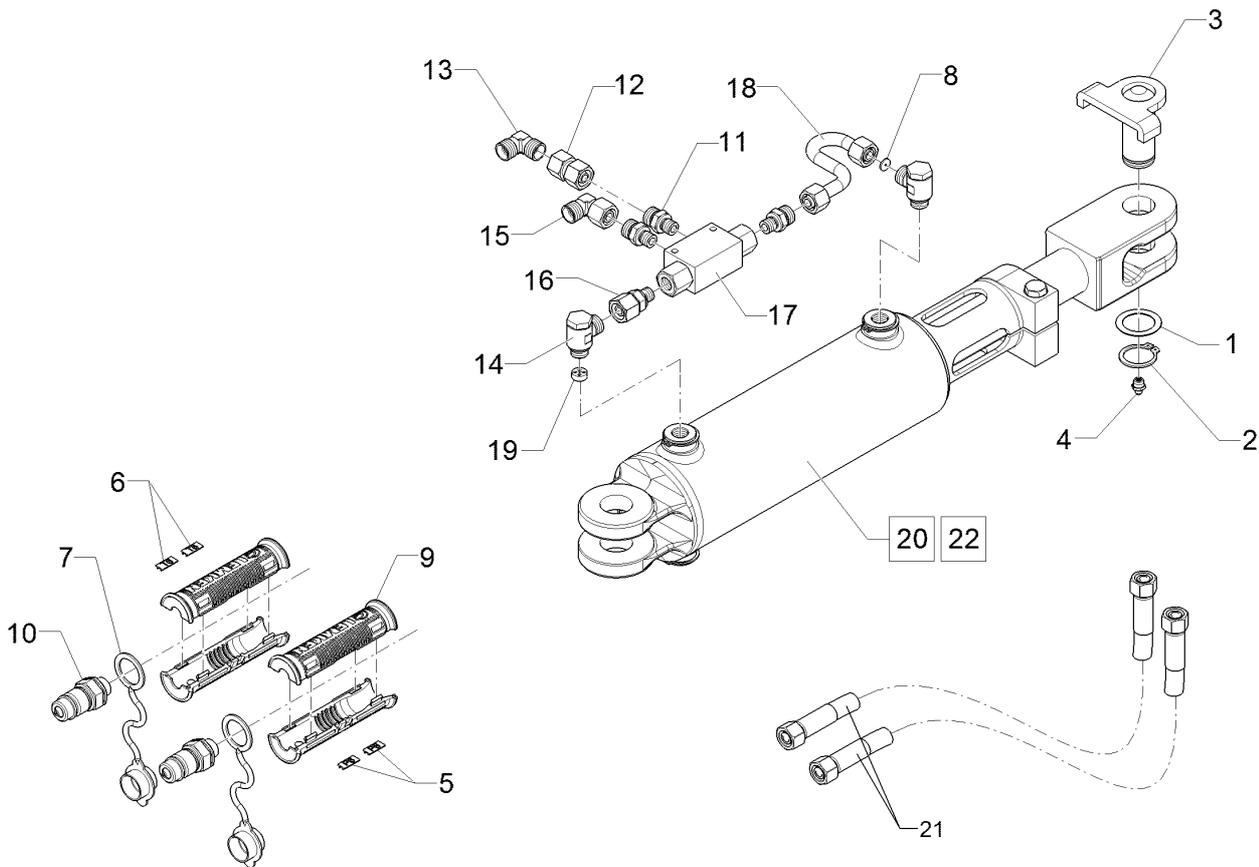

01.18

Pos.	Art.Nr.	Stck.	Artikeltext / Description		Abmessung
1	305 2051	1	Passscheibe	Shim	30x42x1,0 DIN988 Zn
2	305 8867	1	Sicherungsring	Retaining ring	30x2 DIN471 Zn
3	31310060	1	Bolzen	Pin	D30/61x69 U-71 Zn
4	323 6348	1	Schmiernippel	Grease nipple	AM10x1 DIN71412
5	325 1606	2	Kennzeichnung	Marking	P6
6	325 1613	2	Kennzeichnung	Marking	T6
7	375 2123	2	Staubkappe, gelb	Cap	D26,5 Bg.3
8	375 2214	1	Drosselscheibe	Restrictor washer	D12x1,5 BO 2,0
9	375 2607	4	Griff Halbschale	Handle	-
10	375 2718	2	SVK-Stecker	Hydraulic coupling	BG-3 12L M18x1,5
11	375 4038	3	Einschraubverschraubung	Nipple	GE 12-LR 1/4 ZL ED
12	375 4132	1	Verbindung gerade	Connection	DKOL12/DKOL12 M18x1,5
13	375 4210	1	Winkelverschraubung	Elbow union	x-W12-L M18x1,5
14	375 4310	2	Schwenkverschraubung	Union, swivel	x-SWVE12-LM M16x1,5
15	375 4500	1	Einstellbare W-Verschraubung	Adjustable angle union	EW12-LM DKO24 GRD M18x1,5
16	375 4711	1	Stutzen	Stud	x-evGE-12-ED 1/4" DKO 24 GRD
17	57510037	1	Dopp.Rückschv.hy.ent.	Nonreturn valve	DVVG-G1/4 Q=15 l/min
18	57510203	1	Rohr 12x189 2xGEB 1xfürDrossel	Tube	12x2x189 2xGEB 1xDR
19	57510207	1	Drosselrückschlagventil	Throttle nonreturn valve	D14,3/2,0

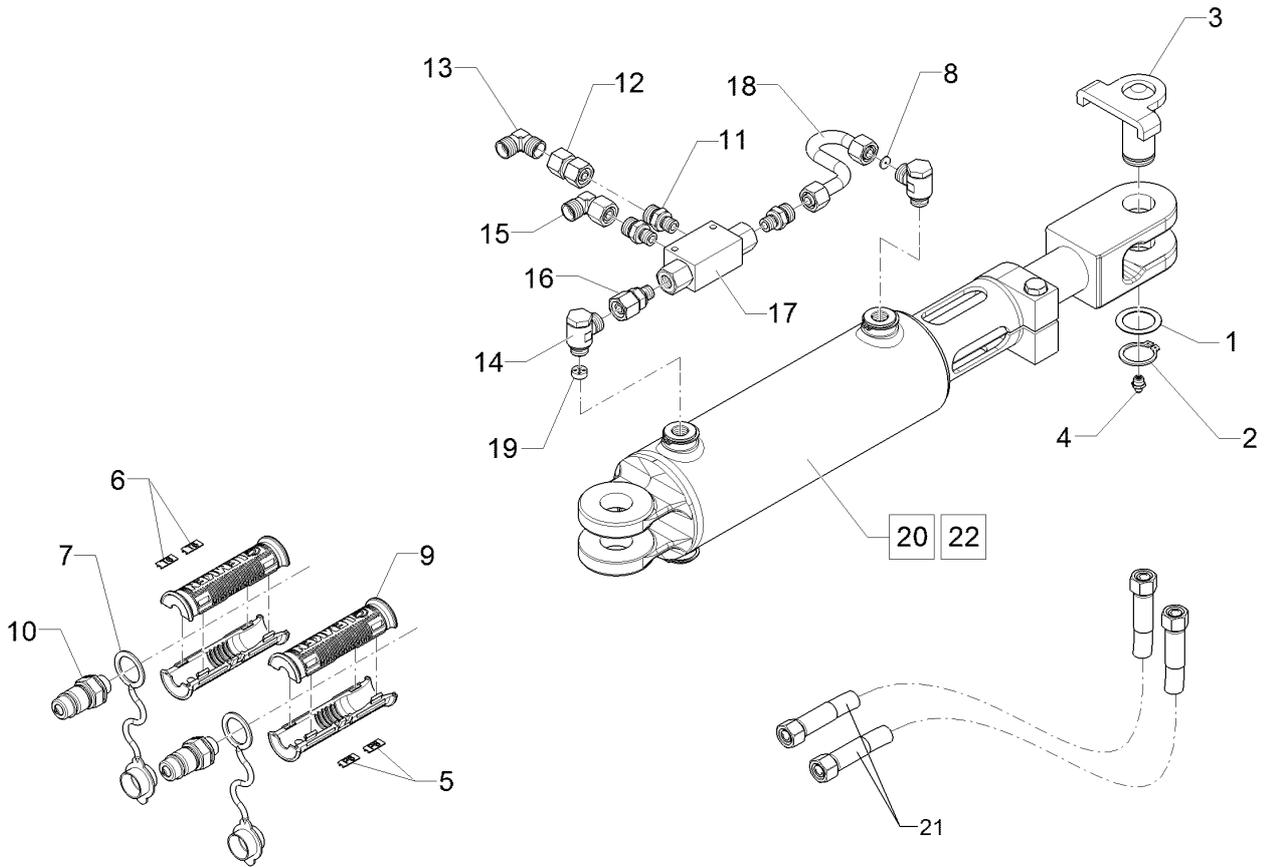

01.18

Pos.	Art.Nr.	Stck.	Artikeltext / Description		Abmessung
20	57510254	1	Einschwenkzylinder	Swing-in ram	DZ90/45x220/680 D30
21	47511143	1	Schlauchpaket	Hose-assembly	Juwel 7M Vf
22	57511084	1	Hydraulikzylinder	Hydraulic ram	DZ090/45x0220-0660 D30 D30

Halter/Holder	10
Juwel 7M	67510627

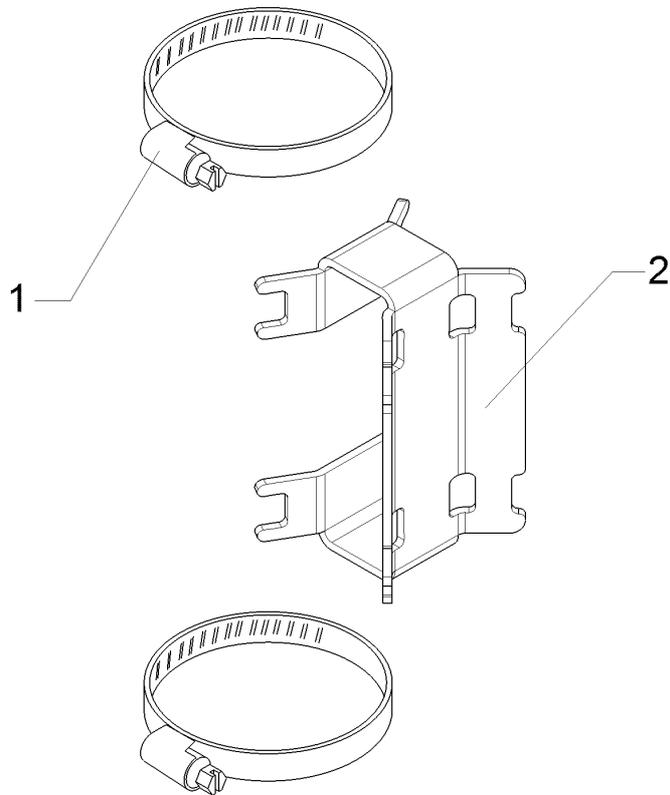

01.18

Pos.	Art.Nr.	Stck.	Artikeltext / Description		Abmessung
1	325 1181	2	Schlauchklemme	Hose clamp	TORRO 90-110/12-C7W4 112x58x67
2	47510879	1	Schlauchführung	Hose guiding	

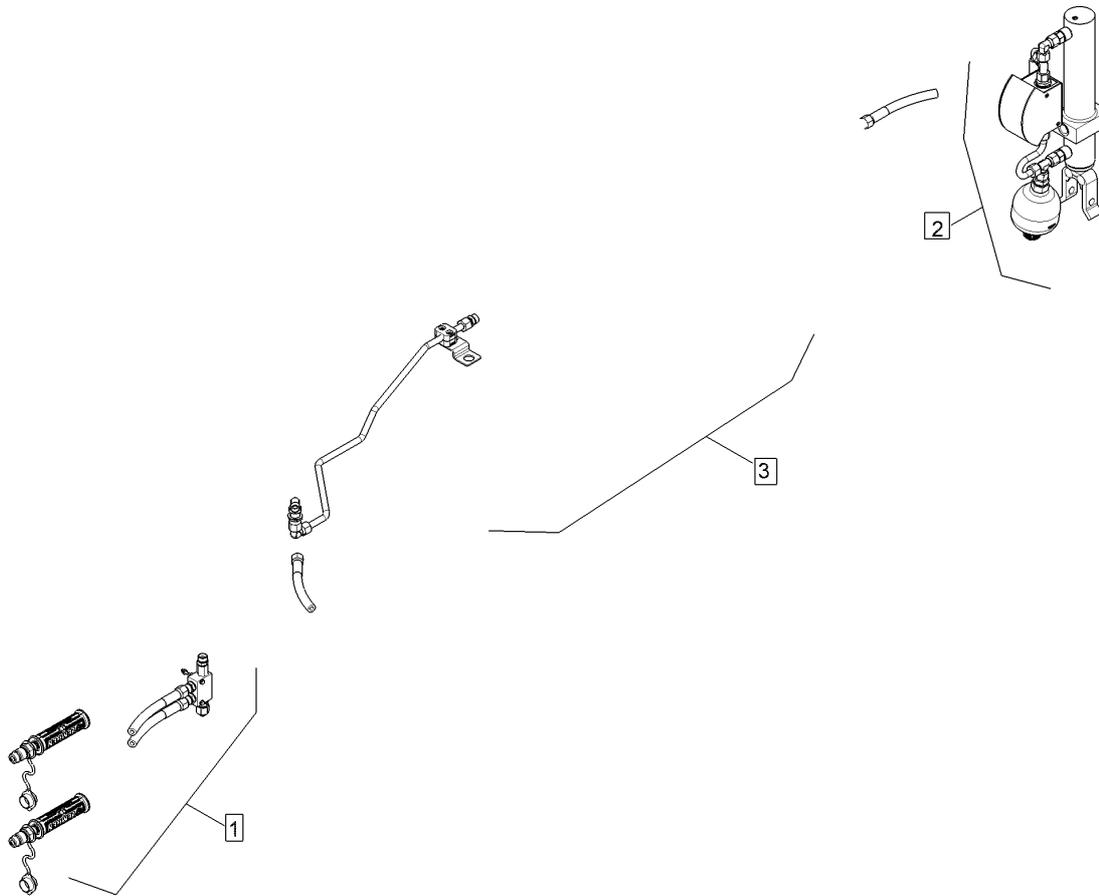

01.18

Pos.	Art.Nr.	Stck.	Artikeltext / Description	Abmessung
1	57511073	1	Hydraulikanlage	Hydraulic assembly
2	57511094	1	Hy-anl. Unirad	HY-assembly depth+transp.wheel
3	57510850	1	Hy-anl. Unirad	HY-assembly depth+transp.wheel

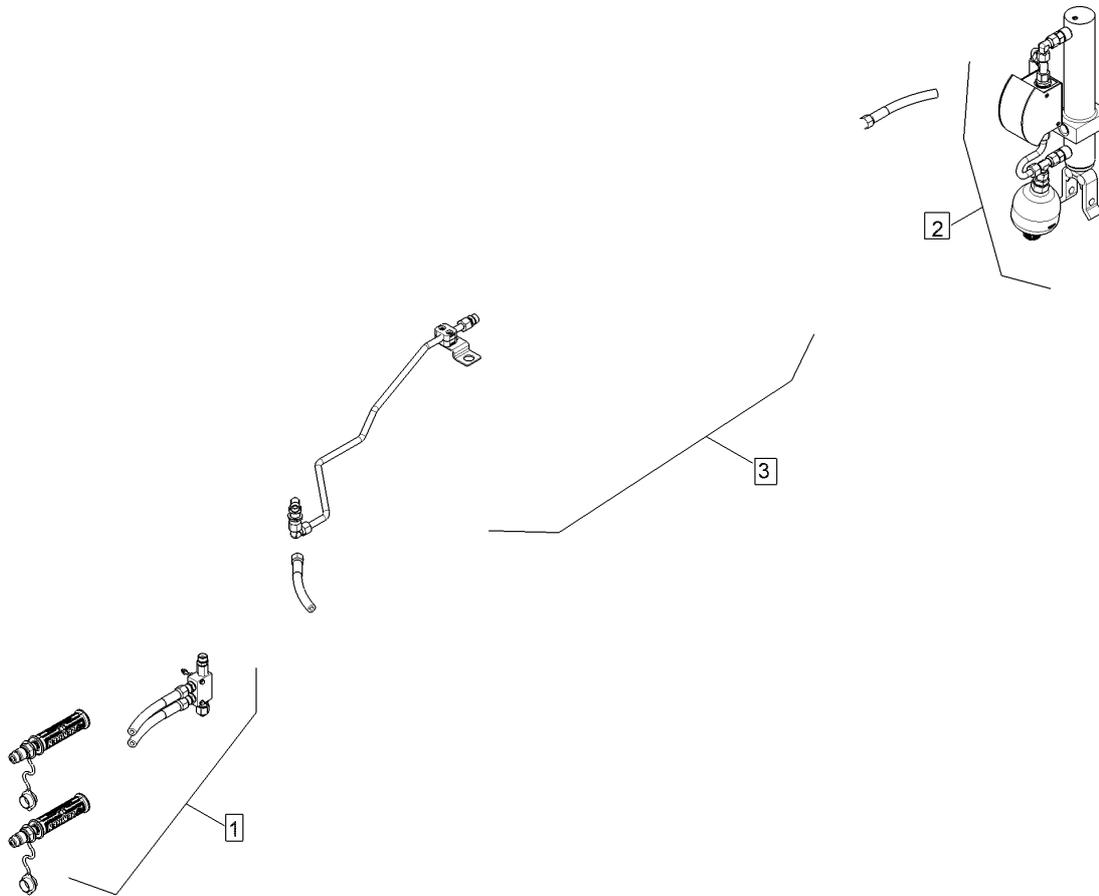

01.18

Pos.	Art.Nr.	Stck.	Artikeltext / Description		Abmessung
1	57511073	1	Hydraulikanlage	Hydraulic assembly	Unirad J7(M) Anschl.Turm
2	57511095	1	Hydraulikanlage	Hydraulic assembly	Unirad Juwel 7(T) 4+1/5-090
3	57510850	1	Hy-anl. Unirad	HY-assembly depth+transp.wheel	Juwel M

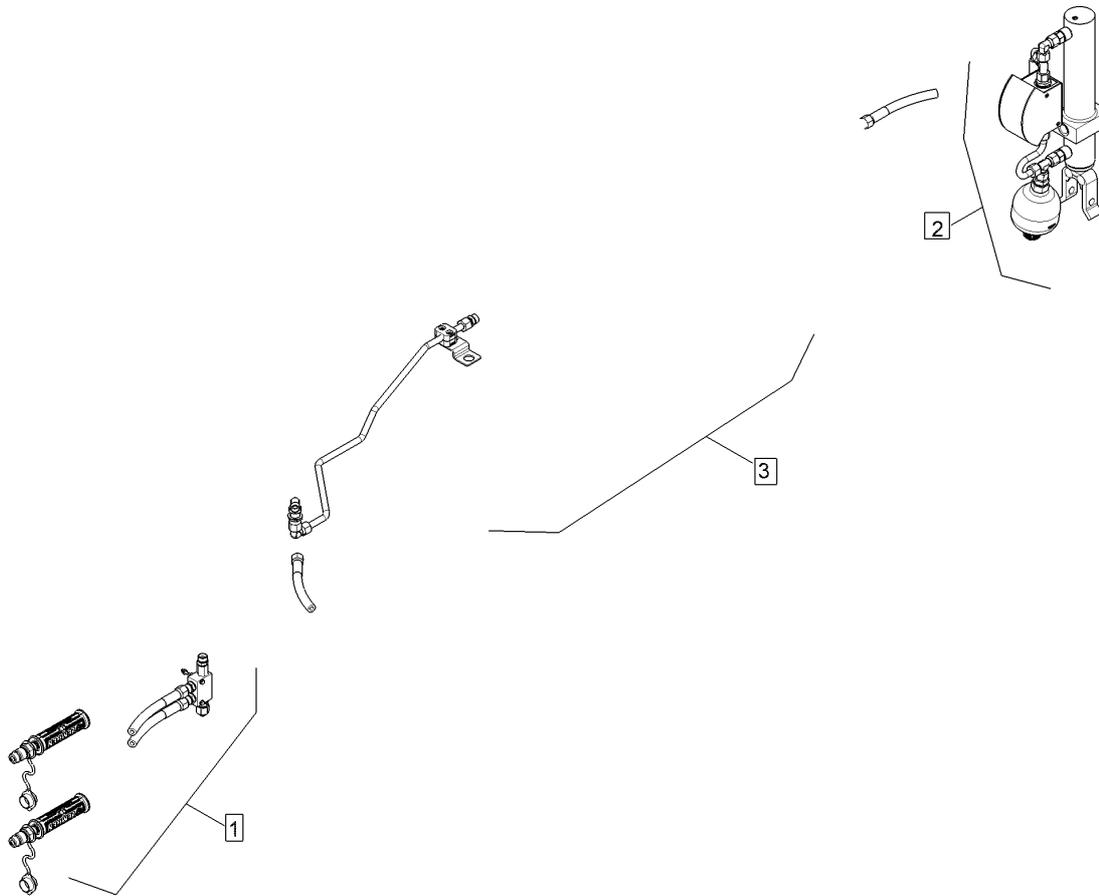

01.18

Pos.	Art.Nr.	Stck.	Artikeltext / Description	Abmessung	
1	57511073	1	Hydraulikanlage	Hydraulic assembly	
2	57510850	1	Hy-anl. Unirad	HY-assembly depth+transp.wheel	Unirad J7(M) Anschl.Turm Juwel M
3	57511096	1	Hydraulikanlage	Hydraulic assembly	Unirad Juwel 7 (T) 3+1/4-100

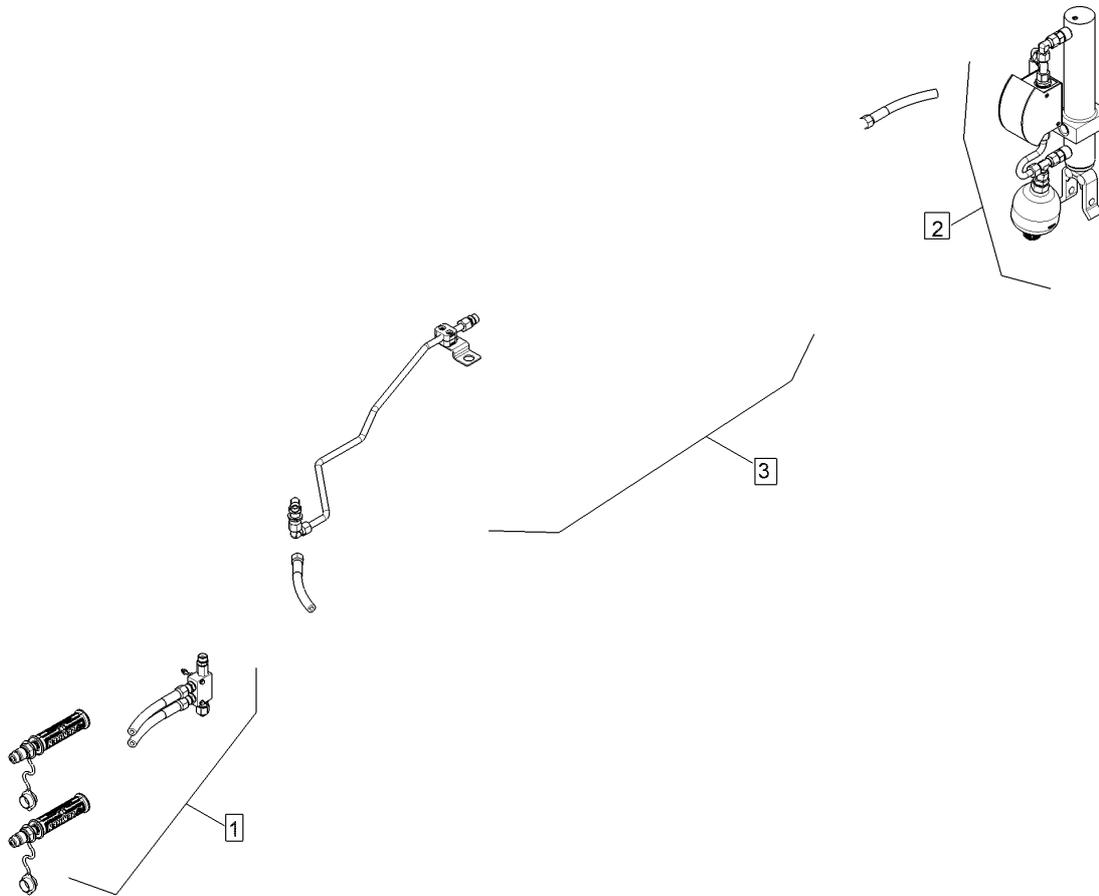

01.18

Pos.	Art.Nr.	Stck.	Artikeltext / Description	Abmessung
1	57511073	1	Hydraulikanlage	Unirad J7(M) Anschl.Turm
2	57510850	1	Hy-anl. Unirad	Juwel M
3	57511097	1	Hydraulikanlage	Unirad Juwel 7 (T) 4+1/5-100

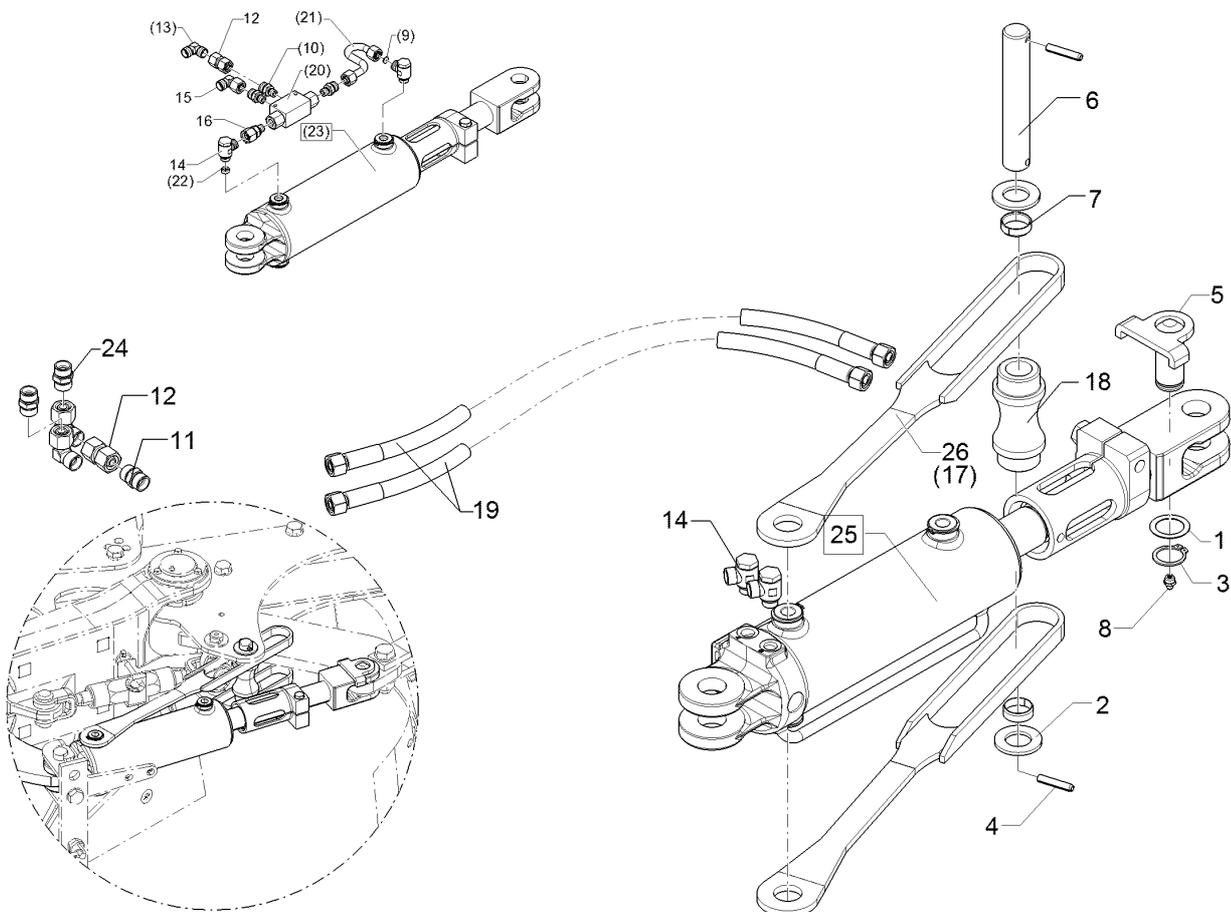

01.18

Pos.	Art.Nr.	Stck.	Artikeltext / Description		Abmessung
1	305 2051	1	Passscheibe	Shim	30x42x1,0 DIN988 Zn
2	305 6283	2	Scheibe	Washer	B28 DIN125
3	305 8867	1	Sicherungsring	Retaining ring	30x2 DIN471 Zn
4	309 6072	2	Spannhülse	Expansion bush	8x40-DIN1481 Zn
5	31310060	1	Bolzen	Pin	D30/61x69 U-71 Zn
6	31310074	1	Bolzen	Pin	D28x175 2xd8 V Zn
7	317 3347	2	Einspannbuchse mit Presssitz	Expansion bush	EG28/32x10
8	323 6348	1	Schmiernippel	Grease nipple	AM10x1 DIN171412
9	375 2214	1	Drosselscheibe	Restrictor washer	D12x1,5 BO 2,0
10	375 4038	3	Einschraubverschraubung	Nipple	GE 12-LR 1/4 ZL ED
11	375 4110	1	Gerade Verschraubung	Nipple	x-G12-L M18x1,5
12	375 4132	1	Verbindung gerade	Connection	DKOL12/DKOL12 M18x1,5
13	375 4210	1	Winkelverschraubung	Elbow union	x-W12-L M18x1,5
14	375 4310	2	Schwenkverschraubung	Union, swivel	x-SWVE12-LM M16x1,5
15	375 4500	2	Einstellbare W-Verschraubung	Adjustable angle union	EW12-LM DKO24 GRD M18x1,5
16	375 4711	1	Stutzen	Stud	x-evGE-12-ED 1/4" DKO 24 GRD
17	40210037	2	Begrenzungsstange	Outer rod	26x65x607 Zn
18	40210044	1	Distanzrohr	Distance tube	D55/45/28x119,5 V Zn
19	47511191	1	Schlauchpaket	Hose-assembly	Juwel 7M L, Ra

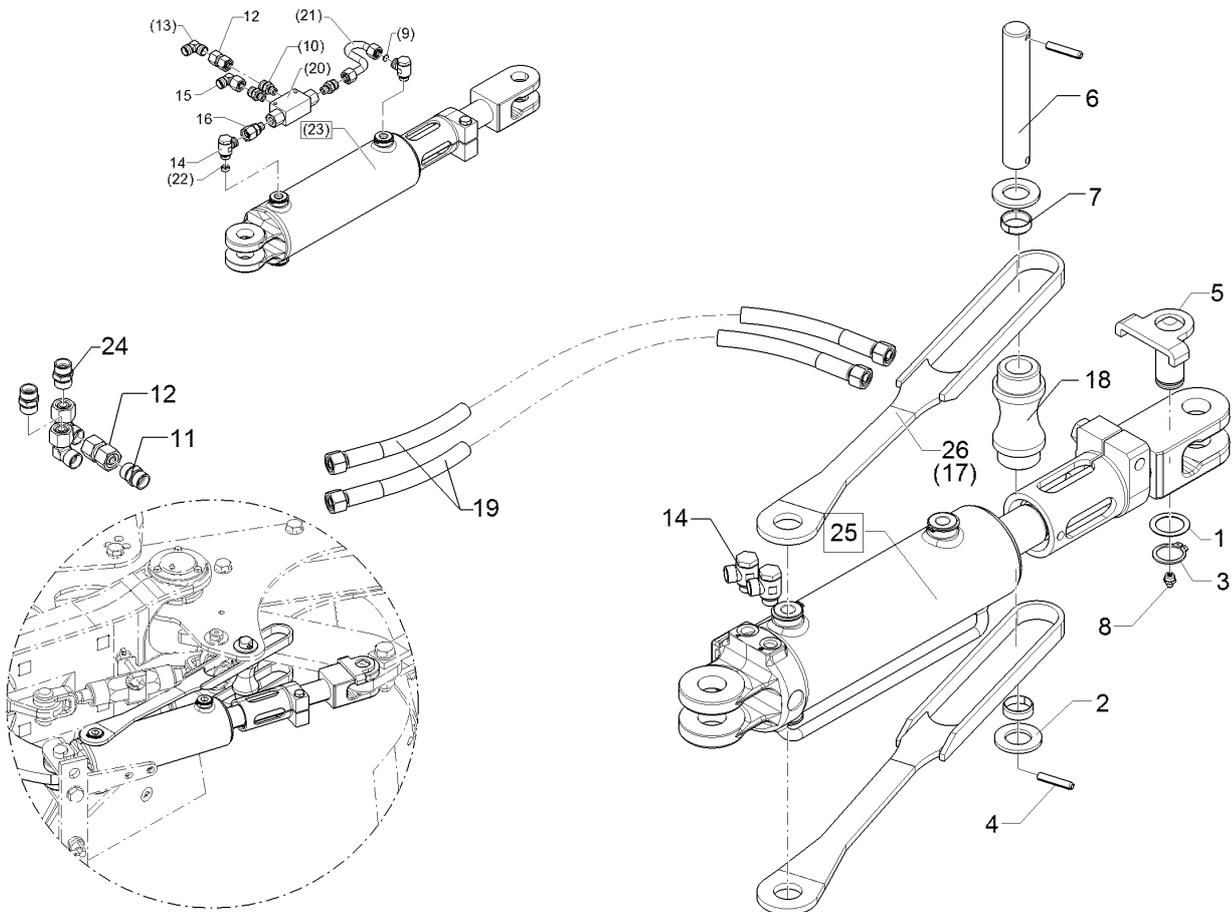

01.18

Pos.	Art.Nr.	Stck.	Artikeltext / Description	Abmessung	
20	57510037	1	Dopp.Rückschv.hy.ent.	Nonreturn valve	DVVG-G1/4 Q=15 l/min
21	57510203	1	Rohr 12x189 2xGEB 1xfürDrossel	Tube	12x2x189 2xGEB
22	57510207	1	Drosselrückschlagventil	Throttle nonreturn valve	1xDR D14,3/2,0
23	57510254	1	Einschwenkzylinder	Swing-in ram	DZ90/45x220/680
24	375 4010	2	Einschraubverschraubung	Nipple	D30 x-GE12-LM M16x1,5 Zn
25	57511084	1	Hydraulikzylinder	Hydraulic ram	DZ090/45x0220-0660
26	40210110	2	Begrenzungsstange	Outer rod	D30 D30 26x65x543 Zn

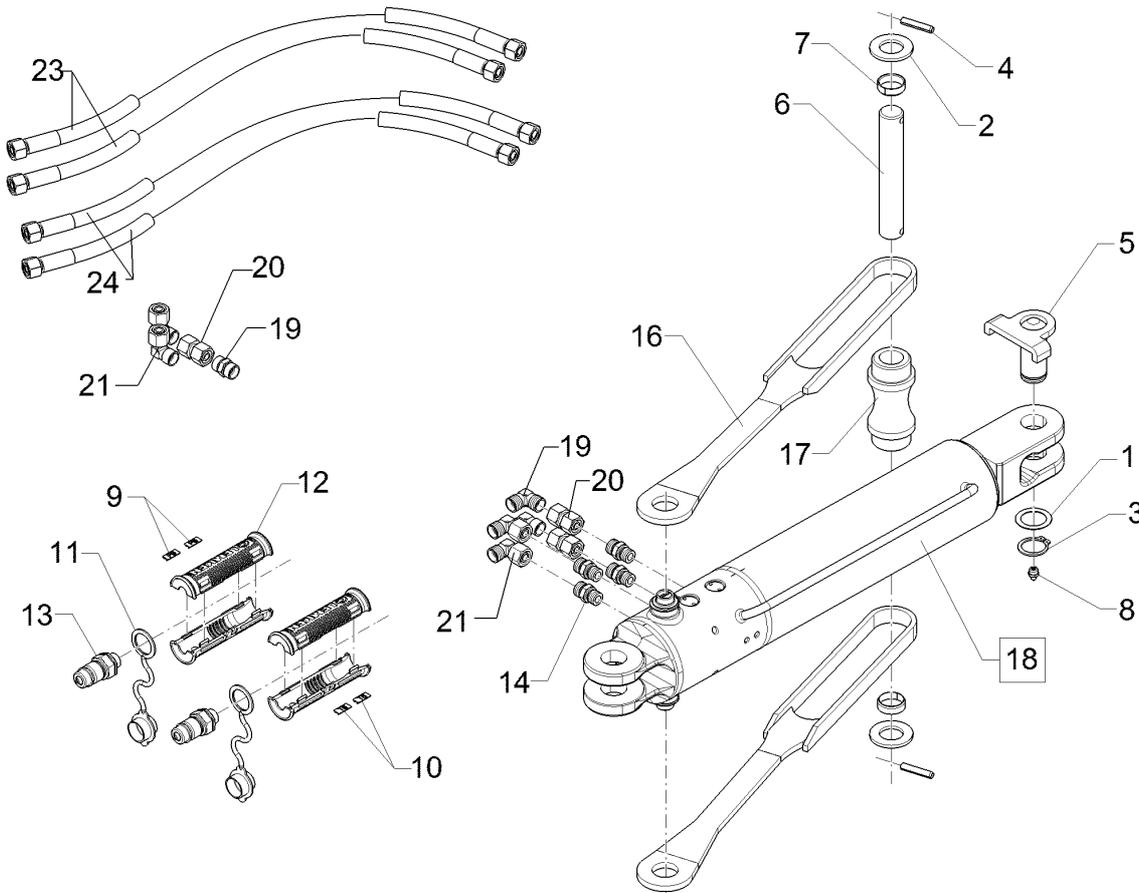

01.18

Pos.	Art.Nr.	Stck.	Artikeltext / Description		Abmessung
1	305 2051	1	Passscheibe	Shim	30x42x1,0 DIN988 Zn
2	305 6283	2	Scheibe	Washer	B28 DIN125
3	305 8867	1	Sicherungsring	Retaining ring	30x2 DIN471 Zn
4	309 6072	2	Spannhülse	Expansion bush	8x40-DIN1481 Zn
5	31310060	1	Bolzen	Pin	D30/61x69 U-71 Zn
6	31310074	1	Bolzen	Pin	D28x175 2xd8 V Zn
7	317 3347	2	Einspannbuchse mit Presssitz	Expansion bush	EG28/32x10
8	323 6348	1	Schmiernippel	Grease nipple	AM10x1 DIN171412
9	325 1606	2	Kennzeichnung	Marking	P6
10	325 1613	2	Kennzeichnung	Marking	T6
11	375 2123	2	Staubkappe, gelb	Cap	D26,5 Bg.3
12	375 2607	4	Griff Halbschale	Handle	-
13	375 2718	2	SVK-Stecker	Hydraulic coupling	BG-3 12L M18x1,5
14	375 4010	4	Einschraubverschraubung	Nipple	x-GE12-LM M16x1,5 Zn
16	40210037	2	Begrenzungsstange	Outer rod	26x65x607 Zn
17	40210044	1	Distanzrohr	Distance tube	D55/45/28x119,5 V Zn
18	57511086	1	Hydraulikzylinder	Hydraulic ram	ME090/45x0220-0660 D30 D30
19	375 4110	1	Gerade Verschraubung	Nipple	x-G12-L M18x1,5
20	375 4132	3	Verbindung gerade	Connection	DKOL12/DKOL12 M18x1,5
21	375 4210	2	Winkelverschraubung	Elbow union	x-W12-L M18x1,5

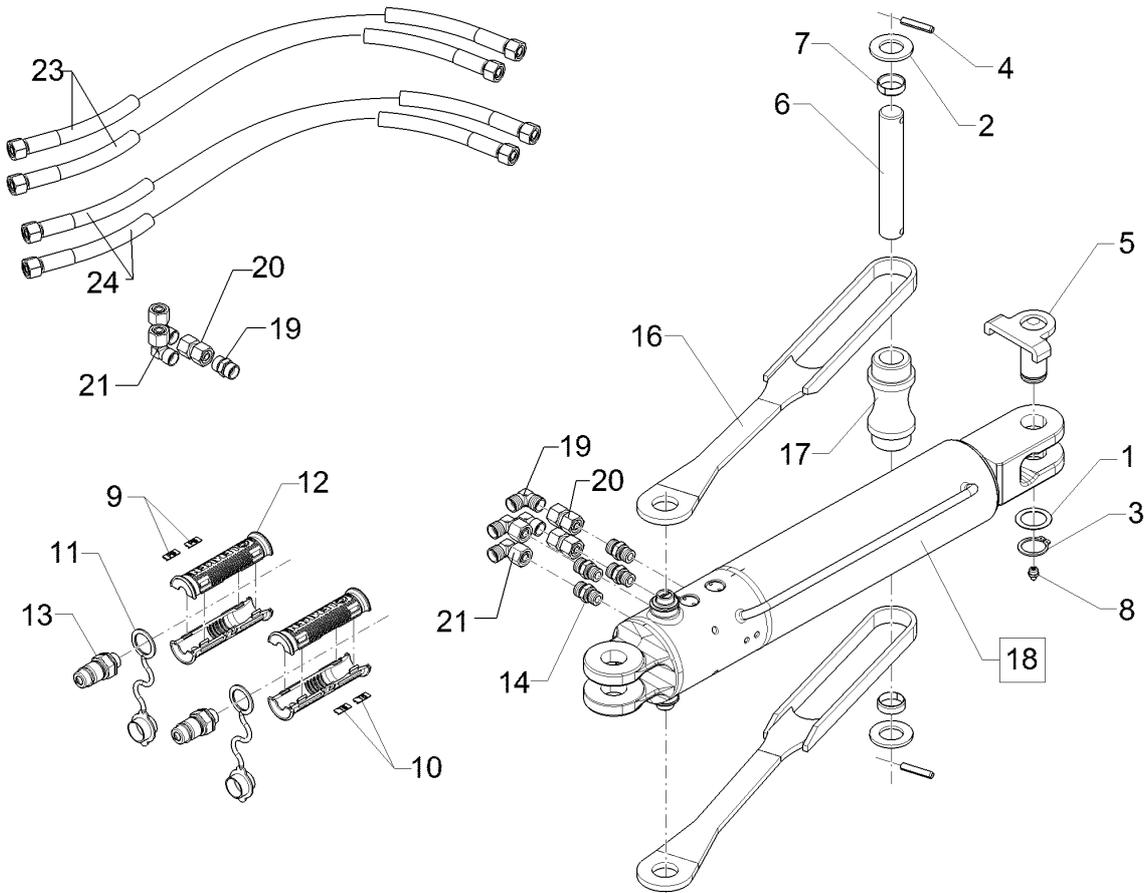

01.18

Pos.	Art.Nr.	Stck.	Artikeltext / Description		Abmessung
22	375 4500	4	Einstellbare W-Verschraubung	Adjustable angle union	EW12-LM DKO24 GRD M18x1,5
23	47511143	1	Schlauchpaket	Hose-assembly	Juwel 7M Vf
24	47511191	1	Schlauchpaket	Hose-assembly	Juwel 7M L, Ra

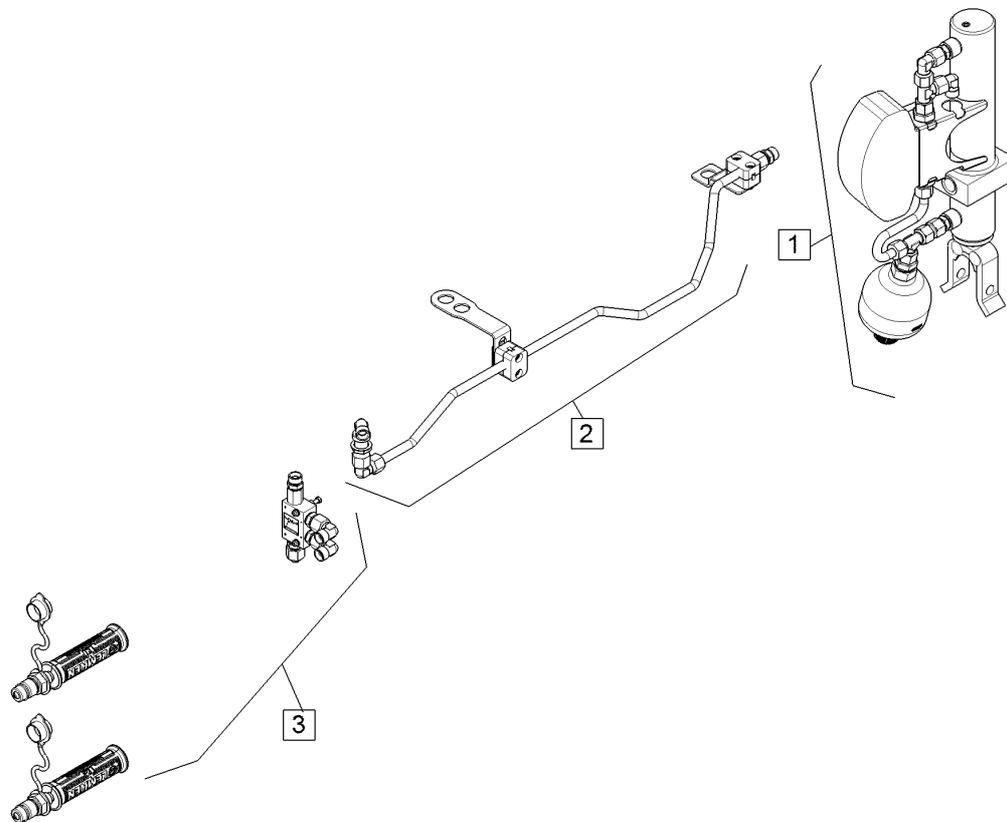

01.18

Pos.	Art.Nr.	Stck.	Artikeltext / Description		Abmessung
1	57510850	1	Hy-anl. Unirad	HY-assembly depth+transp.wheel	Juwel M
2	57511094	1	Hy-anl. Unirad	HY-assembly depth+transp.wheel	Juwel 7(T) 3+1/4-090
3	57511113	1	Hy-anl. Unirad	HY-assembly depth+transp.wheel	Juwel 7 M L

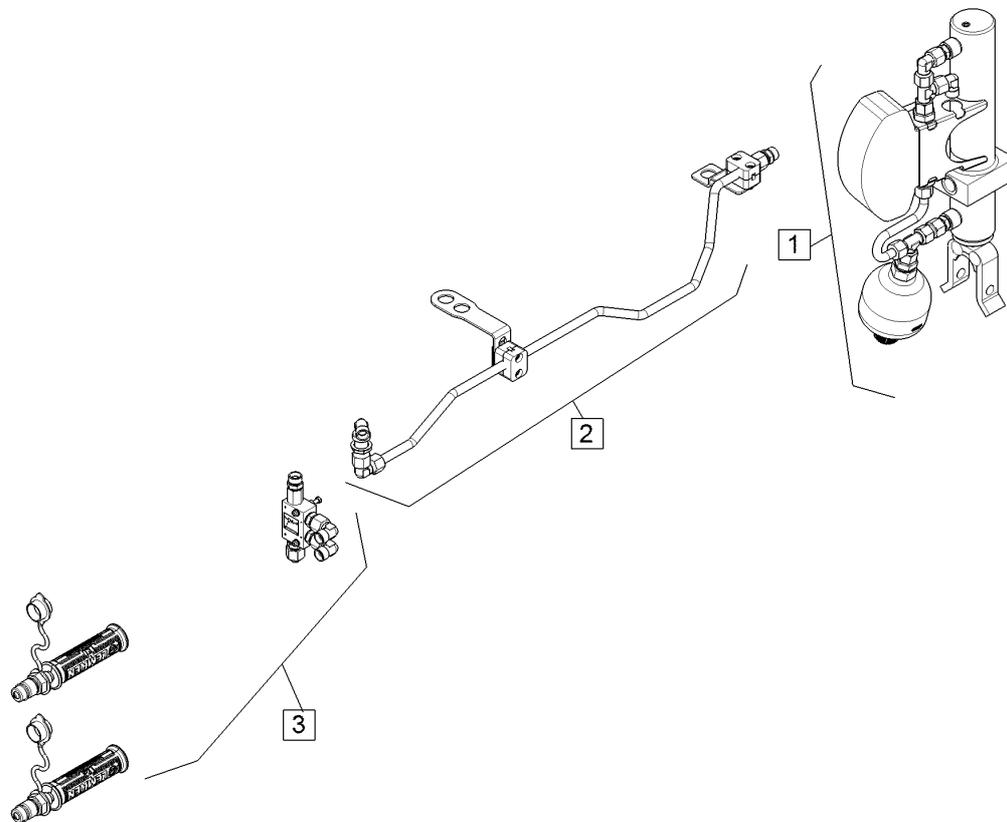

01.18

Pos.	Art.Nr.	Stck.	Artikeltext / Description	Abmessung
1	57510850	1	Hy-anl. Unirad	Juwel M
2	57511095	1	Hydraulikanlage	Unirad Juwel 7(T) 4+1/5-090
3	57511113	1	Hy-anl. Unirad	Juwel 7 M L

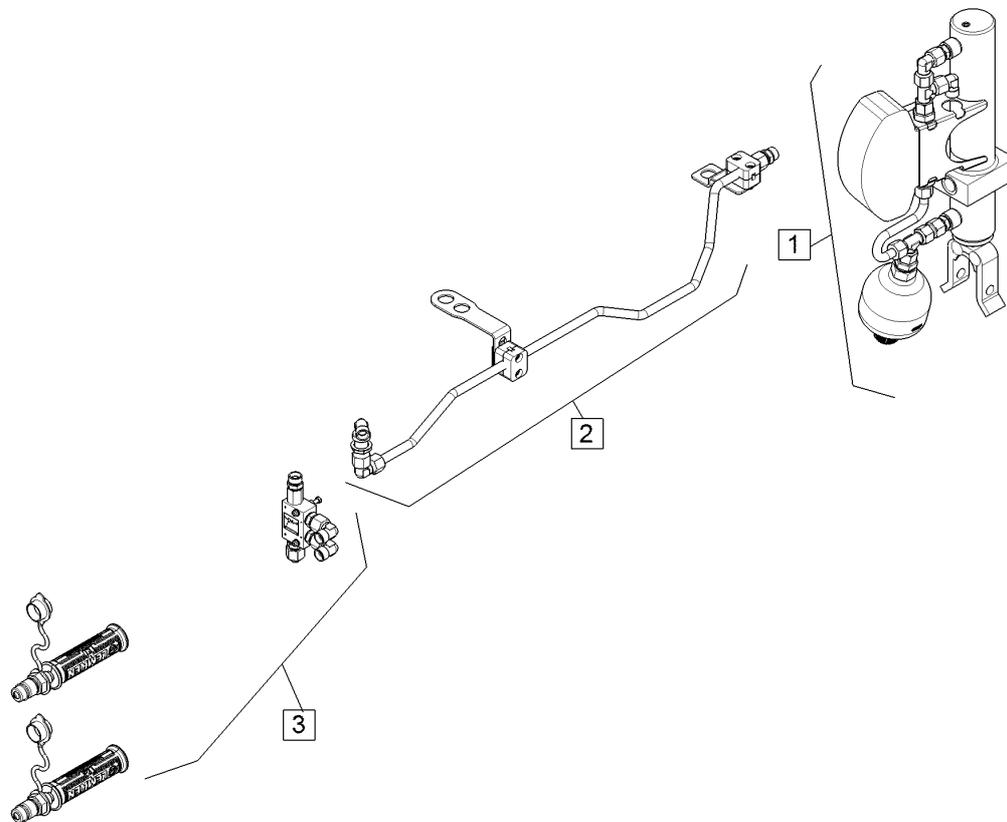

01.18

Pos.	Art.Nr.	Stck.	Artikeltext / Description	Abmessung
1	57510850	1	Hy-anl. Unirad	Juwel M
2	57511096	1	Hydraulikanlage	Unirad Juwel 7 (T) 3+1/4-100
3	57511113	1	Hy-anl. Unirad	Juwel 7 M L

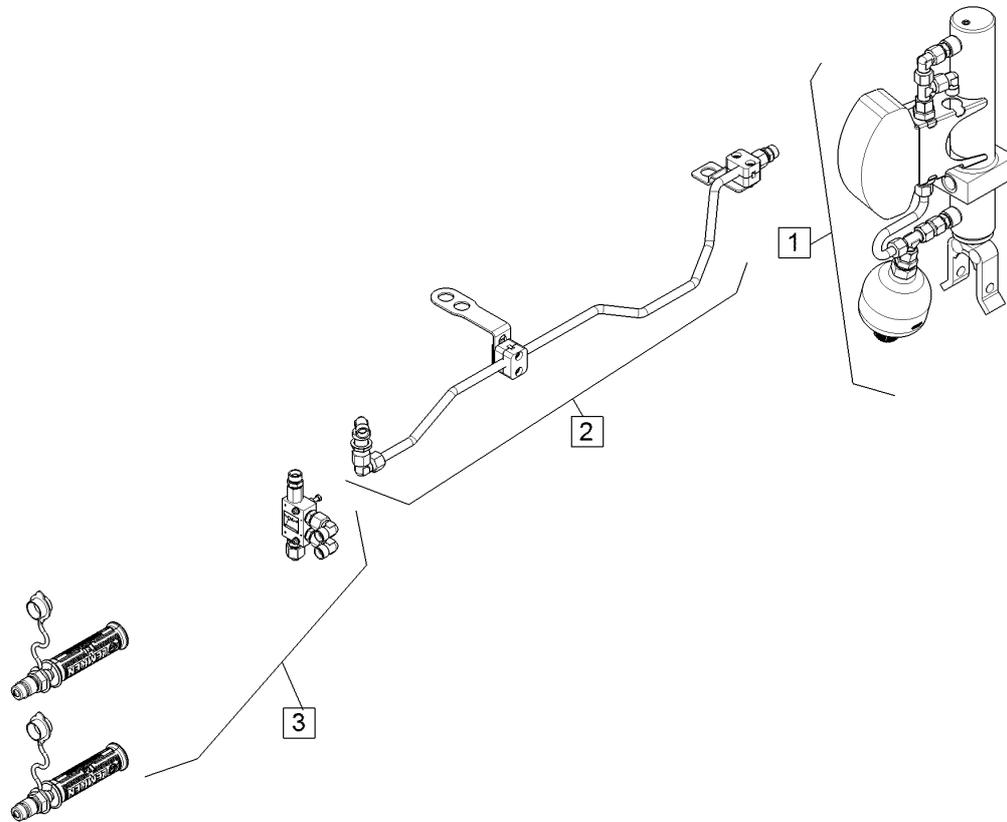

01.18

Pos.	Art.Nr.	Stck.	Artikeltext / Description	Abmessung
1	57510850	1	Hy-anl. Unirad	Juwel M
2	57511097	1	Hydraulikanlage	Unirad Juwel 7 (T) 4+1/5-100
3	57511113	1	Hy-anl. Unirad	Juwel 7 M L

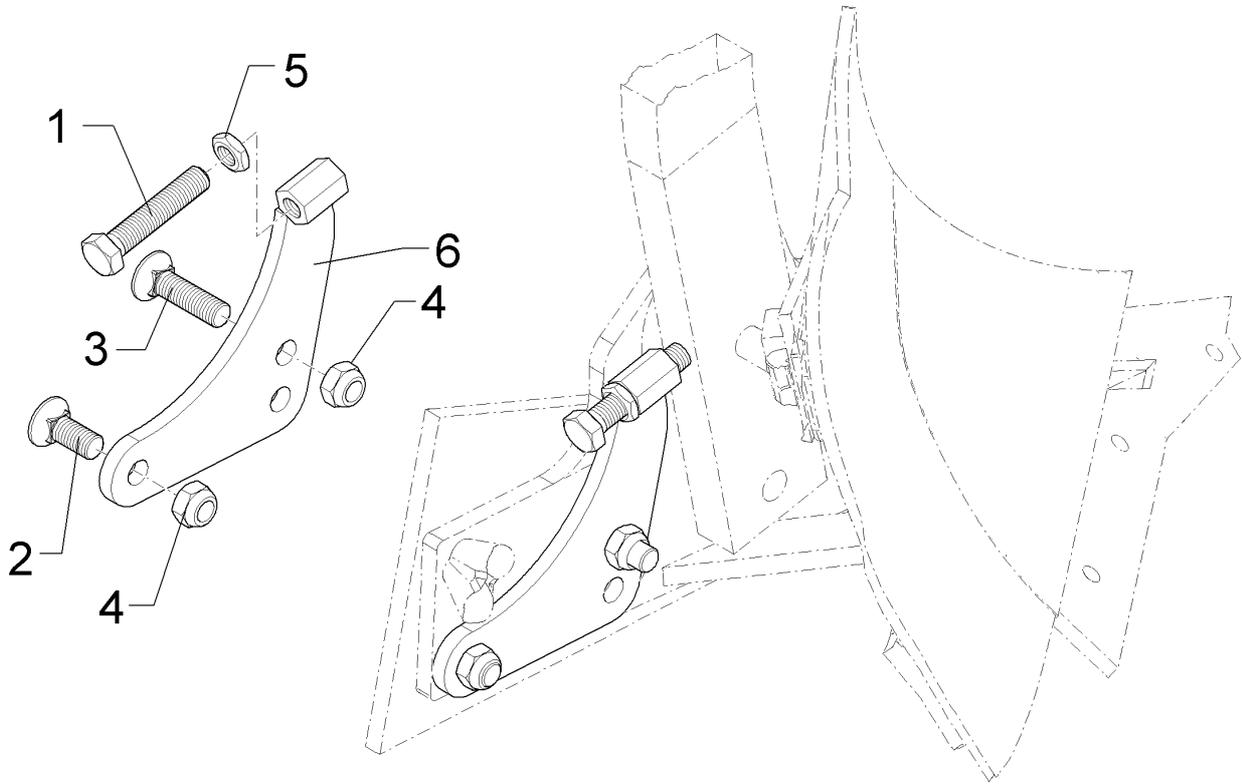

01.18

Pos.	Art.Nr.	Stck.	Artikeltext / Description		Abmessung
1	301 5074	1	Sechskantschraube	Hexagon bolt	M16x80-8.8 Zn DIN933
2	301 6142	1	Senkschraube ohne Mutter	Countersunk bolt	M16x40-10.9 4KT Zn
3	301 6147	1	Senkschraube spz.	Countersunk bolt	M16x60-10.9 4KT Zn
4	303 0935	2	Sicherungsmutter	Selflocking nut	NM16-8 Zn DIN985
5	303 1020	1	Sechskantmutter	Hexagon nut	M16 DIN936-8 Zn
6	46710002	1	Stützplatte	Buck plate	183x162x10 M16 RE

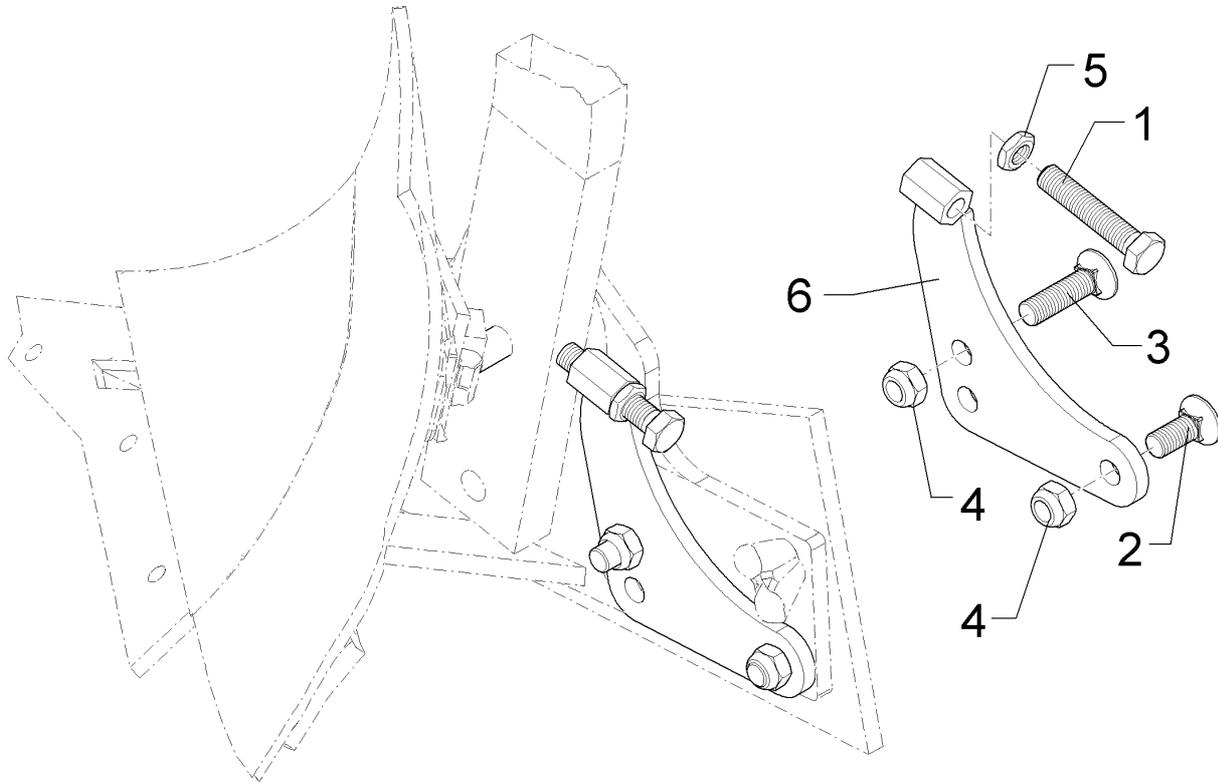

01.18

Pos.	Art.Nr.	Stck.	Artikeltext / Description		Abmessung
1	301 5074	1	Sechskantschraube	Hexagon bolt	M16x80-8.8 Zn DIN933
2	301 6142	1	Senkschraube ohne Mutter	Countersunk bolt	M16x40-10.9 4KT Zn
3	301 6147	1	Senkschraube spz.	Countersunk bolt	M16x60-10.9 4KT Zn
4	303 0935	2	Sicherungsmutter	Selflocking nut	NM16-8 Zn DIN985
5	303 1020	1	Sechskantmutter	Hexagon nut	M16 DIN936-8 Zn
6	46710003	1	Stützplatte	Buck plate	183x162x10 M16 LI

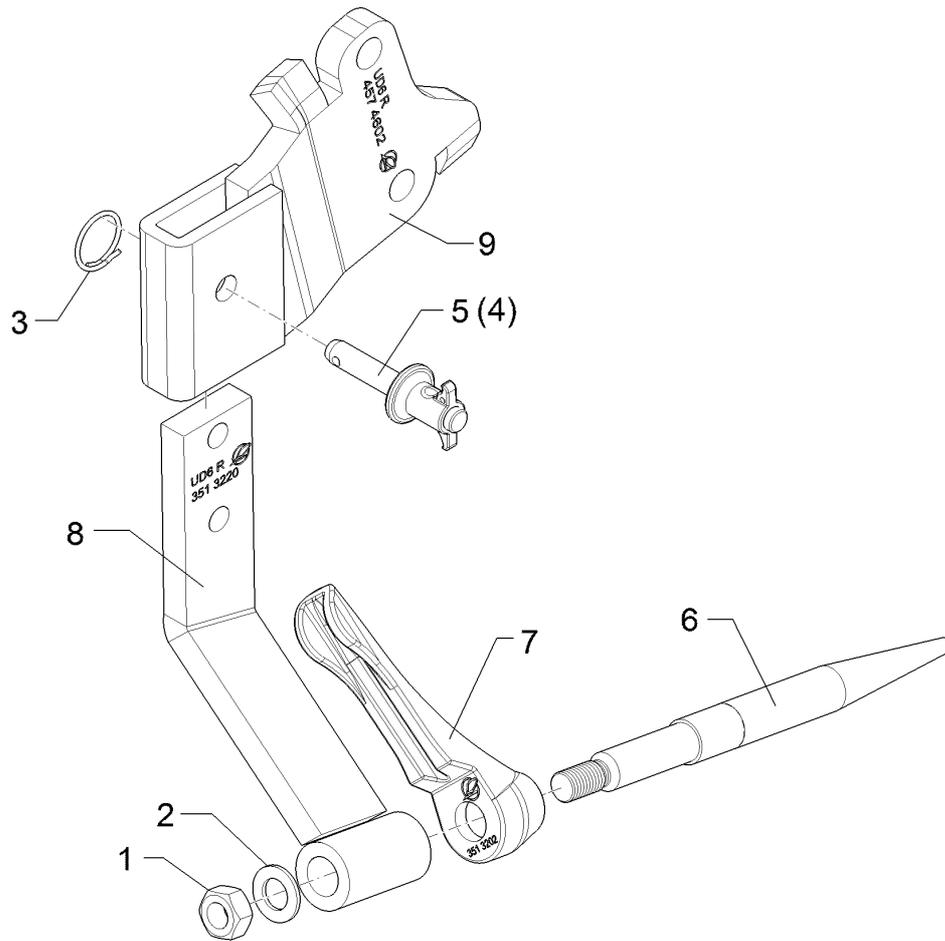

01.18

Pos.	Art.Nr.	Stck.	Artikeltext / Description		Abmessung
1	303 0978	1	Sechskantmutter	Hexagon nut	M20 DIN934-8 Zn
2	305 6012	1	Scheibe	Washer	21 ISO7089 Zn
3	305 8551	1	Sicherungsring	Retaining ring	Di41x3 A2
4	313 8140	1	Bolzen mit Griff	Pin with grip	D16x50,8/70 Zn
5	313 8152	1	Bolzen	Pin	D16x51,7/112 V Zn
6	351 3201	1	Dorn	Tine	D30x360-M20
7	351 3202	1	Halmschutz	Stalk guard	D30/26x48 RE
8	351 3220	1	Halm zum U-Dorn	Stalk for subsoiler	UD6 45 GRD RE
9	457 4602	1	Konsole Untergrunddorn	Bracket	UD6-80 RE

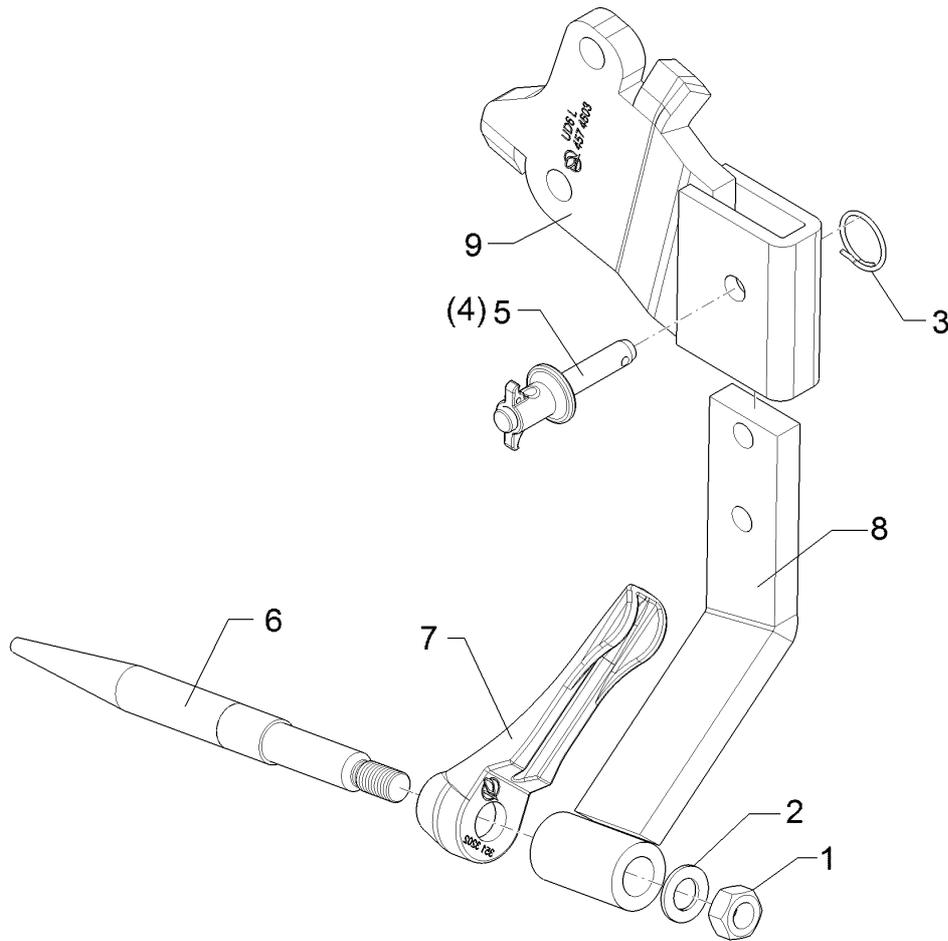

01.18

Pos.	Art.Nr.	Stck.	Artikeltext / Description		Abmessung
1	303 0978	1	Sechskantmutter	Hexagon nut	M20 DIN934-8 Zn
2	305 6012	1	Scheibe	Washer	21 ISO7089 Zn
3	305 8551	1	Sicherungsring	Retaining ring	Di41x3 A2
4	313 8140	1	Bolzen mit Griff	Pin with grip	D16x50,8/70 Zn
5	313 8152	1	Bolzen	Pin	D16x51,7/112 V Zn
6	351 3201	1	Dorn	Tine	D30x360-M20
7	351 3203	1	Halmschutz	Stalk guard	D30/26x48 LI
8	351 3221	1	Halm zum U-Dorn	Stalk for subsoiler	UD6 45 GRD LI
9	457 4603	1	Konsole Untergrunddorn	Bracket	UD6-80 LI

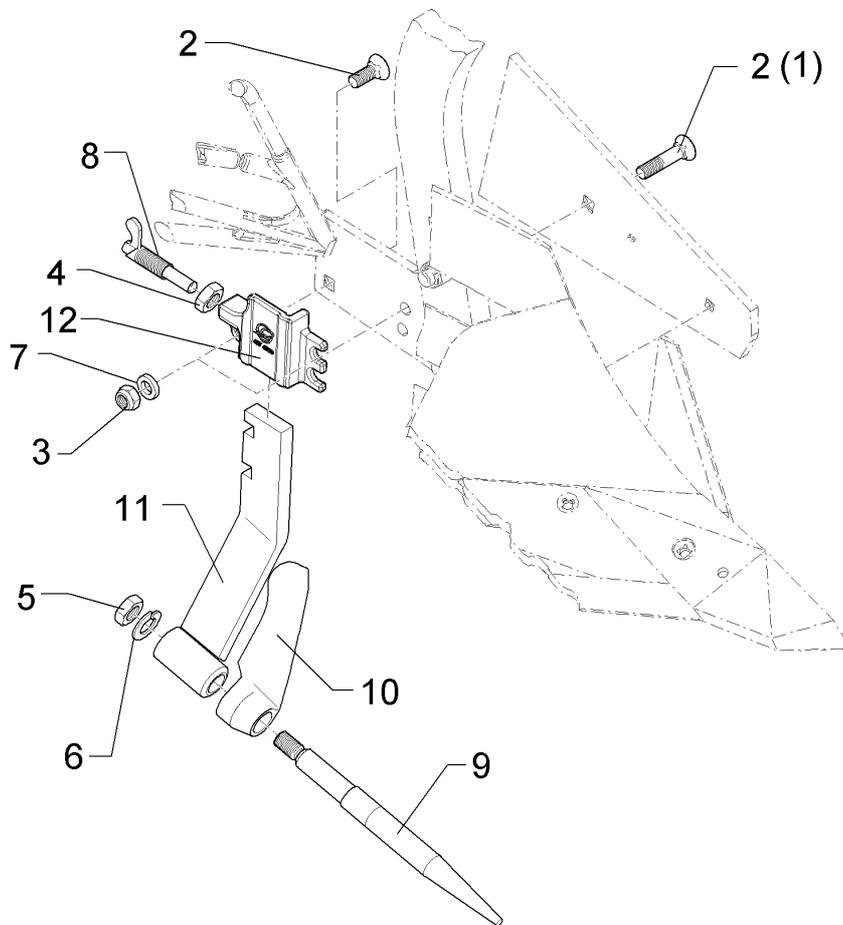

01.18

Pos.	Art.Nr.	Stck.	Artikeltext / Description		Abmessung
1	301 6142	1	Senkschraube ohne Mutter	Countersunk bolt	M16x40-10.9 4KT Zn
2	301 6147	2	Senkschraube spz.	Countersunk bolt	M16x60-10.9 4KT Zn
3	303 0935	2	Sicherungsmutter	Selflocking nut	NM16-8 Zn DIN985
4	303 0965	1	Sechskantmutter	Hexagon nut	M20x1,5 DIN936-17H Zn
5	303 0978	1	Sechskantmutter	Hexagon nut	M20 DIN934-8 Zn
6	305 6012	1	Scheibe	Washer	21 ISO7089 Zn
7	305 6141	2	Scheibe	Washer	17/30x3 DIN/ISO-7089
8	321 2603	1	Federriegel	Locking bar	D15 H=14 L=43/85 Zn vergütet
9	351 3201	1	Dorn	Tine	D30x360-M20
10	351 3202	1	Halmschutz	Stalk guard	D30/26x48 RE
11	351 3222	1	Halm zum U-Dorn	Stalk for subsoiler	DMUDH-1 RE
12	457 4508	1	Halter für U-Dorn	Holder	DMUDH-1 RE

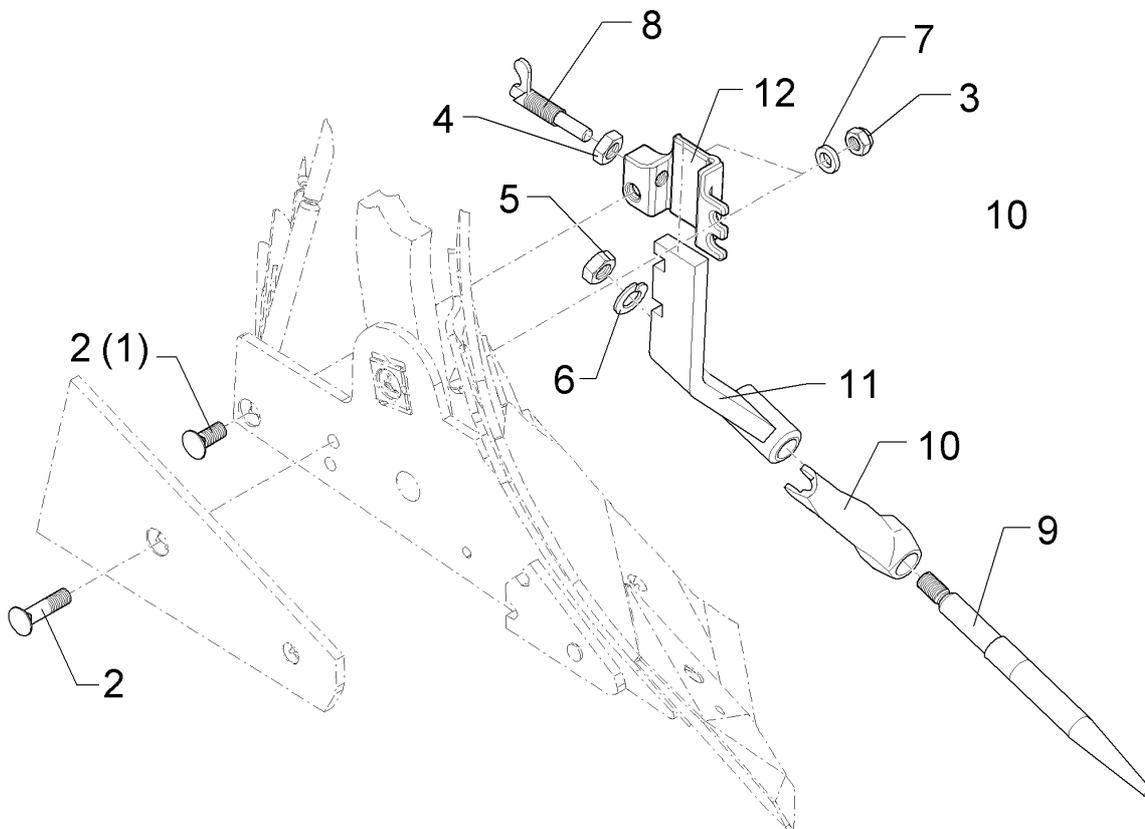

01.18

Pos.	Art.Nr.	Stck.	Artikeltext / Description		Abmessung
1	301 6142	1	Senkschraube ohne Mutter	Countersunk bolt	M16x40-10.9 4KT Zn
2	301 6147	2	Senkschraube spz.	Countersunk bolt	M16x60-10.9 4KT Zn
3	303 0935	2	Sicherungsmutter	Selflocking nut	NM16-8 Zn DIN985
4	303 0965	1	Sechskantmutter	Hexagon nut	M20x1,5 DIN936-17H Zn M20 DIN934-8 Zn
5	303 0978	1	Sechskantmutter	Hexagon nut	M20 DIN934-8 Zn
6	305 6012	1	Scheibe	Washer	21 ISO7089 Zn
7	305 6141	2	Scheibe	Washer	17/30x3 DIN/ISO-7089
8	321 2603	1	Federriegel	Locking bar	D15 H=14 L=43/85 Zn vergütet
9	351 3201	1	Dorn	Tine	D30x360-M20
10	351 3203	1	Halmschutz	Stalk guard	D30/26x48 LI
11	351 3223	1	Halm zum U-Dorn	Stalk for subsoiler	DMUDH-1 LI
12	457 4509	1	Halter für U-Dorn	Holder	DMUDH-1 LI

Anlage mit Schrauben/Landside with bolt	11
--	-----------

Juwel 7M	66710076
-----------------	-----------------

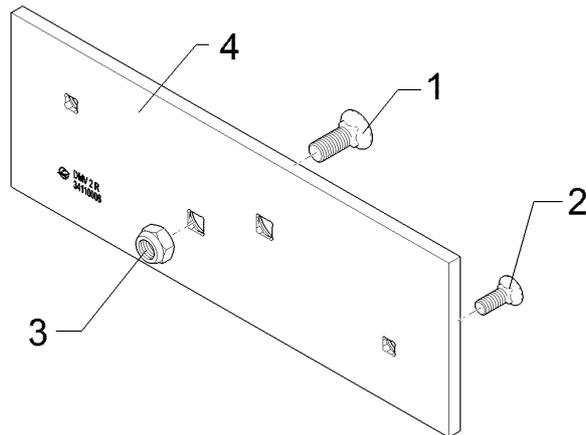

01.18

Pos.	Art.Nr.	Stck.	Artikeltext / Description		Abmessung
1	301 6142	1	Senkschraube ohne Mutter	Countersunk bolt	M16x40-10.9 4KT Zn
2	301 5785	1	Senkschraube	Countersunk bolt	M12x33-12.9-MU-10 Zn
3	303 0935	1	Sicherungsmutter	Selflocking nut	NM16-8 Zn DIN985
4	34110006	1	Anlage	Landside	DMV2 RE 160x12x460

Anlage mit Schrauben/Landside with bolt	11
---	----

Juwel 7M	66710077
----------	----------

01.18

Pos.	Art.Nr.	Stck.	Artikeltext / Description		Abmessung
1	301 6142	1	Senkschraube ohne Mutter	Countersunk bolt	M16x40-10.9 4KT Zn
2	301 5785	1	Senkschraube	Countersunk bolt	M12x33-12.9-MU-10 Zn
3	303 0935	1	Sicherungsmutter	Selflocking nut	NM16-8 Zn DIN985
4	34110007	1	Anlage	Landside	DMV2 LI 160x12x460

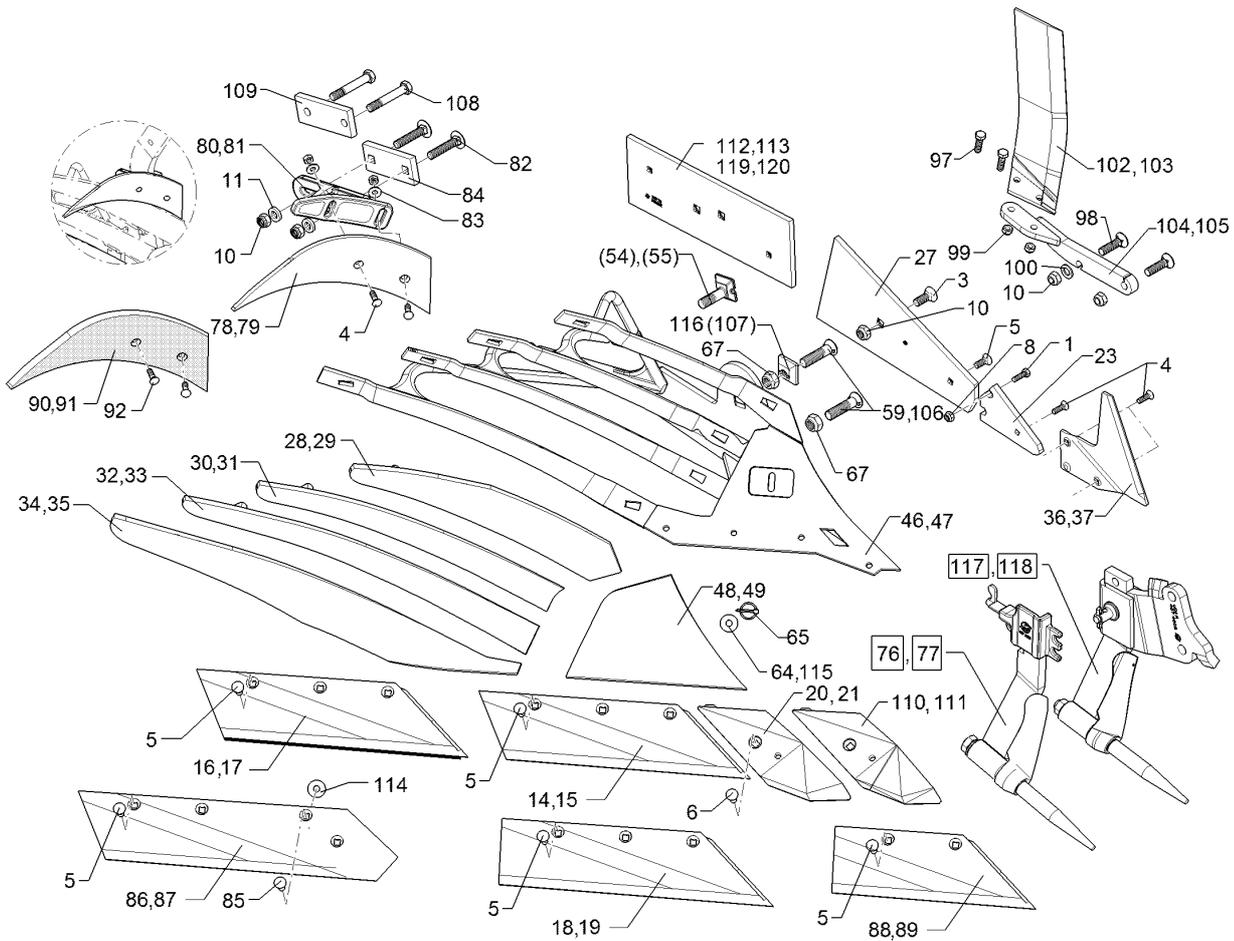

01.18

Pos.	Art.Nr.	Stck.	Artikeltext / Description		Abmessung
1	301 3212	1	Sechskantschraube	Hexagon bolt	M10x25-8.8 Zn DIN933
3	301 6142	1	Senkschraube ohne Mutter	Countersunk bolt	M16x40-10.9 4KT Zn
4	301 5767	2	Senkschraube	Countersunk bolt	M10x33-12.9-MU-10 Zn
5	301 5785	1	Senkschraube	Countersunk bolt	M12x33-12.9-MU-10 Zn
6	301 5789	1	Senkschraube	Countersunk bolt	M12x36x4-12.9-MU-10 Zn
8	303 0933	1	Sicherungsmutter	Selflocking nut	NM10-8 DIN985 Zn
10	303 0935	2	Sicherungsmutter	Selflocking nut	NM16-8 Zn DIN985
11	305 6161	2	Scheibe	Washer	17/40x6 DIN7349 Zn
14	335 2134	1	Scharblatt	Wing	SB56D RE 558x150x11
15	335 2135	1	Scharblatt	Wing	SB56D LI 558x150x11
16	335 2234	1	Scharblatt	Wing	SB56P RE 558x150x11
17	335 2235	1	Scharblatt	Wing	SB56P LI 558x150x11
18	335 2138	1	Scharblatt	Wing	SB58D RE
19	335 2139	1	Scharblatt	Wing	SB58D LI
20	336 4156	1	Scharspitze gepanzert	Point	SC2P RE
21	336 4157	1	Scharspitze gepanzert	Point	SC2P LI
23	340 1903	1	Anlagekeil	Landside wedge	AK12W 12x103x170
27	341 1525	1	Anlage	Landside	DMV1
28	344 4418	1	Streichblechstreifen	Mouldboard slat	1 DMCS40 RE

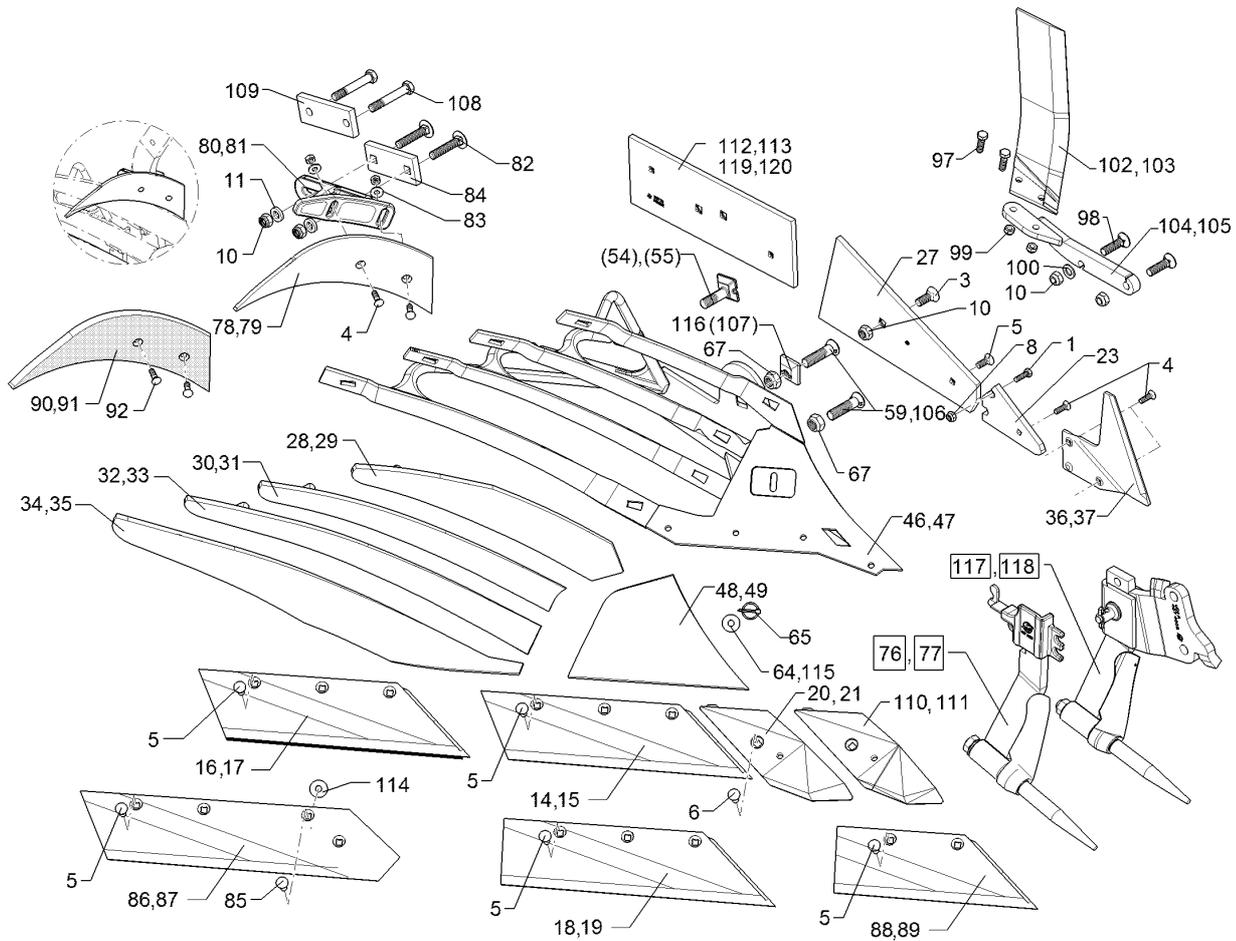

01.18

Pos.	Art.Nr.	Stck.	Artikeltext / Description	Abmessung	
29	344 4419	1	Streichblechstreifen	Mouldboard slat	1 DMCS40 LI
30	344 4428	1	Streichblechstreifen	Mouldboard slat	2 DMCS40 RE
31	344 4429	1	Streichblechstreifen	Mouldboard slat	2 DMCS40 LI
32	344 4438	1	Streichblechstreifen	Mouldboard slat	3 DMCS40 RE
33	344 4439	1	Streichblechstreifen	Mouldboard slat	3 DMCS40 LI
34	344 4448	1	Streichblechstreifen	Mouldboard slat	4 DMCS40 RE
35	344 4449	1	Streichblechstreifen	Mouldboard slat	4 DMCS40 LI
36	349 2890	1	Anlagesech	Sword coultter	AS2 RE 6x238x240
37	349 2891	1	Anlagesech	Sword coultter	AS2 LI 6x238x240
46	467 1040	1	Körperrumpf	Frog	DMCS RE
47	467 1041	1	Körperrumpf	Frog	DMCS LI
48	345 1030	1	Streichblechkante	Shin	DMCK RE
49	345 1031	1	Streichblechkante	Shin	DMCK LI
54	301 5780	1	Exzentrerschraube	Eccentric screw	M20x75-12.9 R Zn
55	301 5781	1	Exzentrerschraube	Eccentric screw	M20x75-12.9 L Zn
59	301 5747	1	Senkschraube	Countersunk bolt	M20x70x8,5-12.9 Zn
64	305 6167	1	Scheibe	Washer	13/35x5 Zn DIN 6340
65	31110015	1	Sicherheitsklapstecker	Securing pin	5x32 d1=4,5 Zn
67	303 0936	2	Sicherungsmutter	Selflocking nut	NM20-8 Zn DIN985
76	657 4612	1	Untergrunddorn	Subsoiler	DMUD-1 RE
77	657 4613	1	Untergrunddorn	Subsoiler	DMUD-1 LI
78	347 0860	1	Einlegehand	Trashboard	E4 RE
79	347 0861	1	Einlegehand	Trashboard	E4 LI

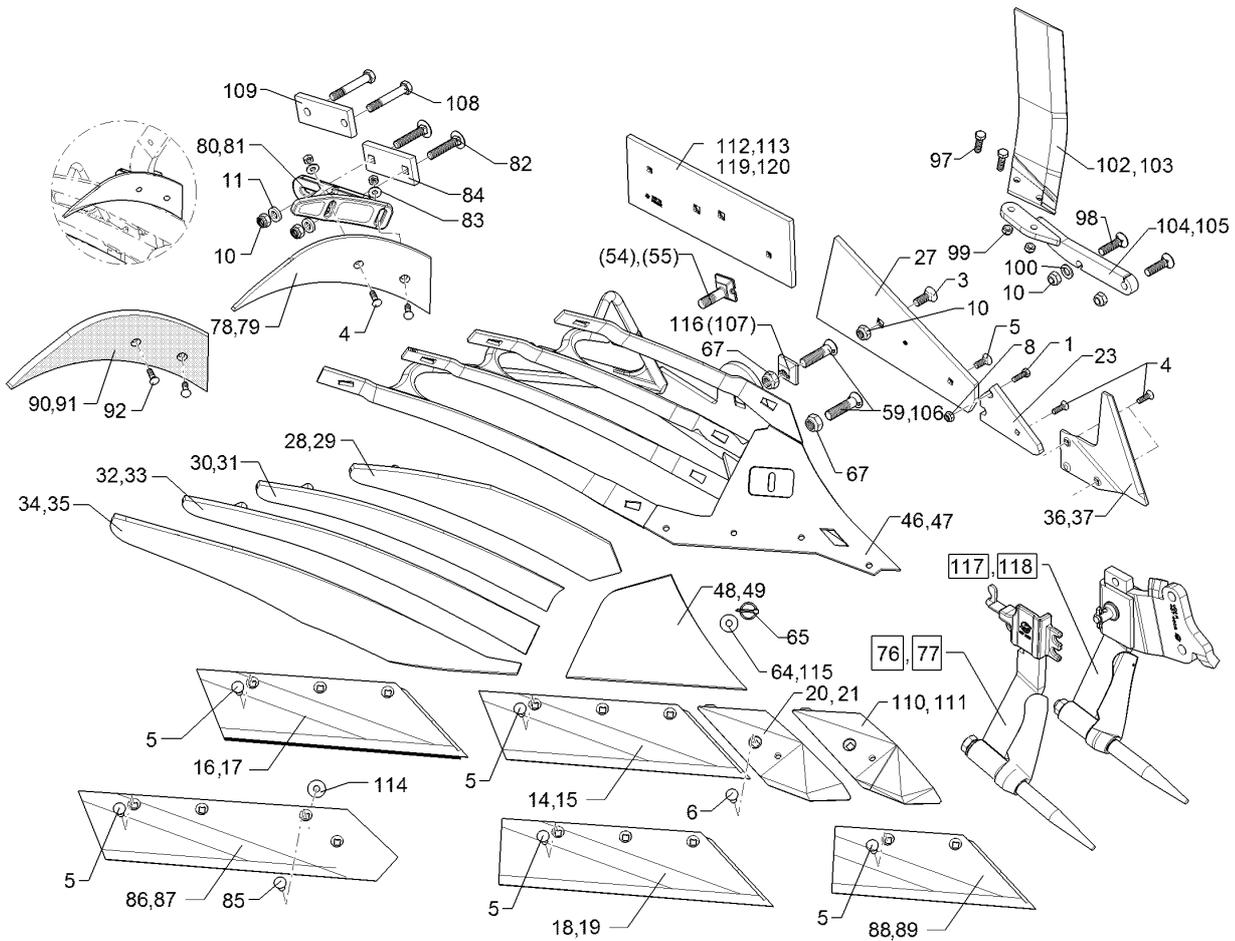

01.18

Pos.	Art.Nr.	Stck.	Artikeltext / Description		Abmessung
80	457 5218	1	Halter	Holder	DM1 E4 RE
81	457 5219	1	Halter	Holder	DM1 E4 LI
82	301 2292	2	Flachrundschaube	Saucer-head screw	M16x80-10.9 Zn
83	305 6132	2	Scheibe	Washer	D11/25x2,5 Zn
84	459 1194	1	Brücke	Clamp plate	60x15x138
85	301 5794	1	Senkschraube	Countersunk bolt	1x97-4Kt17 M12x45-12.9-MU-10 DIN608 Zn
86	333 5032	1	Steinschar	Share	S42A RE 670x150x11
87	333 5033	1	Steinschar	Share	S42A LI 670x150x11
88	335 2120	1	Scharblatt	Wing	SB43D RE 428x150x11
89	335 2121	1	Scharblatt	Wing	SB43D LI 428x150x11
90	347 0862	1	Einlegehand	Trashboard	E4KU RE
91	347 0863	1	Einlegehand	Trashboard	E4KU LI
92	301 5769	1	Senkschraube	Countersunk bolt	M10x45-12.9-MU-10 Zn
97	301 3347	2	Sechskantschraube	Hexagon bolt	M12x40-8.8 Zn DIN933
98	301 6147	2	Senkschraube spz.	Countersunk bolt	M16x60-10.9 4KT Zn
99	303 0934	2	Sicherungsmutter	Selflocking nut	NM12-8 Zn DIN985
100	305 6141	1	Scheibe	Washer	17/30x3 DIN/ISO-7089
102	349 2860	1	Breitfurchenmesser	Knife for wide furrows	BFM-RE
103	349 2861	1	Breitfurchenmesser	Knife for wide furrows	BFM-LI

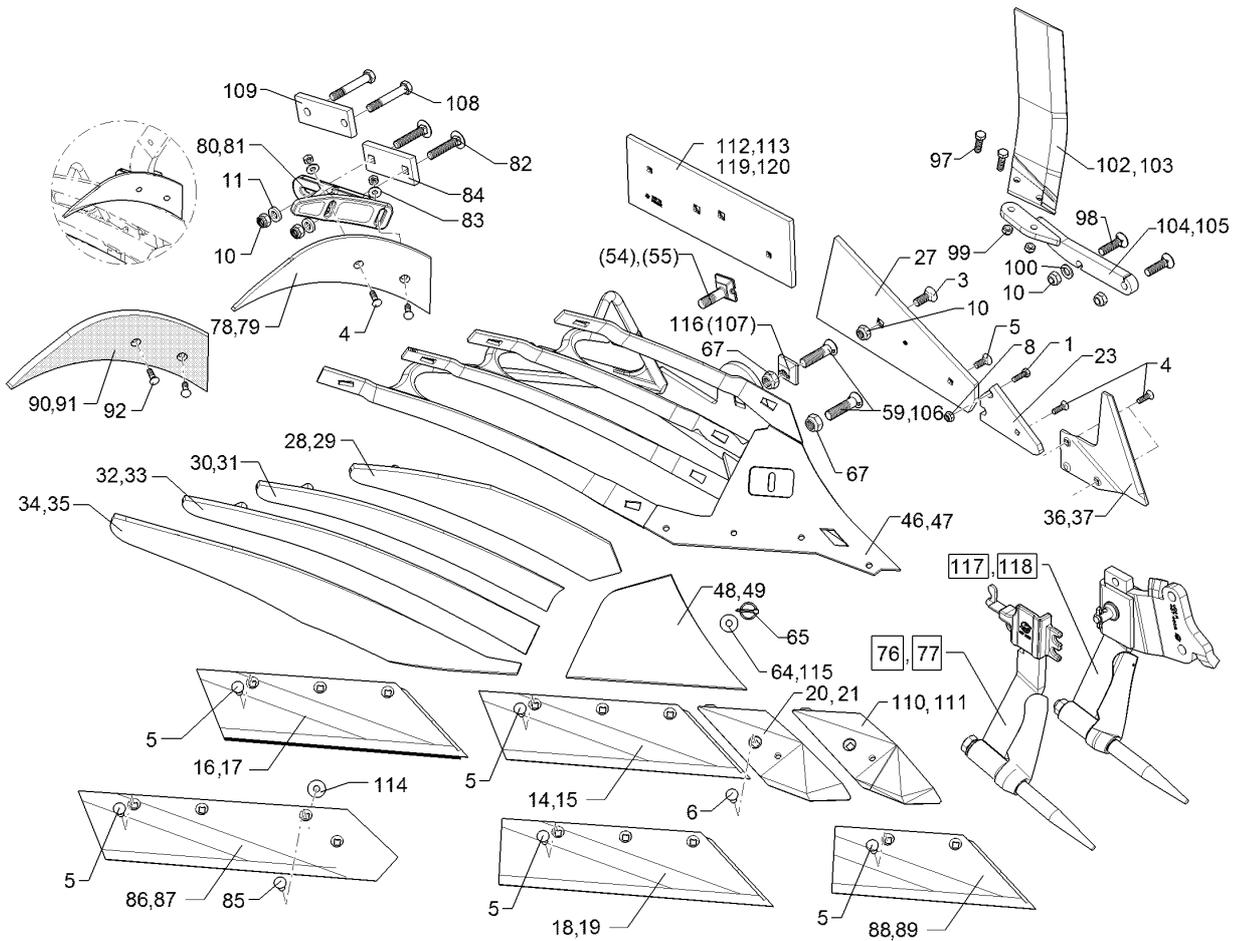

01.18

Pos.	Art.Nr.	Stck.	Artikeltext / Description	Abmessung	
104	45710008	1	Halter	Holder	BFM 3 RE DuraMaxx
105	45710009	1	Halter	Holder	BFM 3 LI DuraMaxx
106	301 5750	1	Senkschraube	Countersunk bolt	M20x80x8,5-12.9 Zn
107	31710028	1	Exzentrerscheibe	Eccentric washer	50x50x16 D20,25 Zn
108	301 3994	2	Sechskantschraube spz.	Hexagon bolt	M16x100-12.9 Zn
109	459 1169	1	Brücke	Clamp plate	60x15x152 2xD17-107
110	33610006	1	Scharspitze	Point	SC2PS RE
111	33610007	1	Scharspitze	Point	SC2PS LI
112	34110002	1	Anlage	Landside	DMV2 RE
113	34110003	1	Anlage	Landside	DMV2 LI
114	305 6180	1	Scheibe	Washer	160x12x460
115	305 8582	1	Scheibe	Washer	15 DIN7349
116	31710191	1	Exzentrerscheibe	Eccentric washer	160x12x460 13/32x1,25 St-Zn
117	657 4608	1	Untergrunddorn	Subsoiler	D20,25 Zn
118	657 4609	1	Untergrunddorn	Subsoiler	UD6-80 RE
119	66710076	1	Anlage mit Schrauben	Landside with bolt	UD6-80 LI
120	66710077	1	Anlage mit Schrauben	Landside with bolt	DMV2 RE
					DMV2 LI

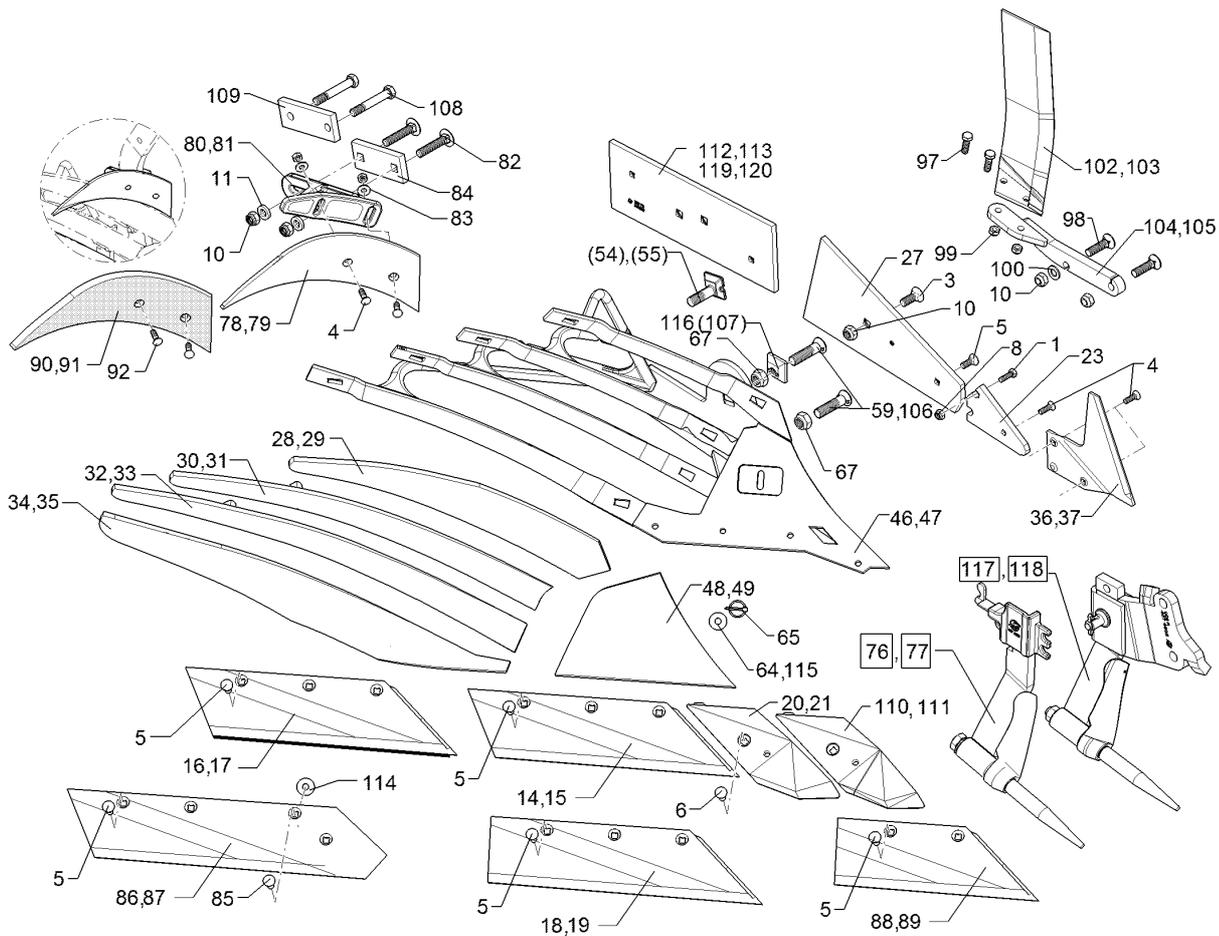

01.18

Pos.	Art.Nr.	Stck.	Artikeltext / Description		Abmessung
1	301 3212	1	Sechskantschraube	Hexagon bolt	M10x25-8.8 Zn DIN933
3	301 6142	1	Senkschraube ohne Mutter	Countersunk bolt	M16x40-10.9 4KT Zn
4	301 5767	2	Senkschraube	Countersunk bolt	M10x33-12.9-MU-10 Zn
5	301 5785	1	Senkschraube	Countersunk bolt	M12x33-12.9-MU-10 Zn
6	301 5789	1	Senkschraube	Countersunk bolt	M12x36x4-12.9-MU-10 Zn
8	303 0933	1	Sicherungsmutter	Selflocking nut	NM10-8 DIN985 Zn
10	303 0935	2	Sicherungsmutter	Selflocking nut	NM16-8 Zn DIN985
11	305 6161	2	Scheibe	Washer	17/40x6 DIN7349 Zn
14	335 2134	1	Scharblatt	Wing	SB56D RE 558x150x11
15	335 2135	1	Scharblatt	Wing	SB56D LI 558x150x11
16	335 2234	1	Scharblatt	Wing	SB56P RE 558x150x11
17	335 2235	1	Scharblatt	Wing	SB56P LI 558x150x11
18	335 2138	1	Scharblatt	Wing	SB58D RE
19	335 2139	1	Scharblatt	Wing	SB58D LI
20	336 4156	1	Scharspitze gepanzert	Point	SC2P RE
21	336 4157	1	Scharspitze gepanzert	Point	SC2P LI
23	340 1903	1	Anlagekeil	Landside wedge	AK12W 12x103x170
27	341 1525	1	Anlage	Landside	DMV1
28	344 4420	1	Streichblechstreifen	Mouldboard slat	1 DMCS50 RE

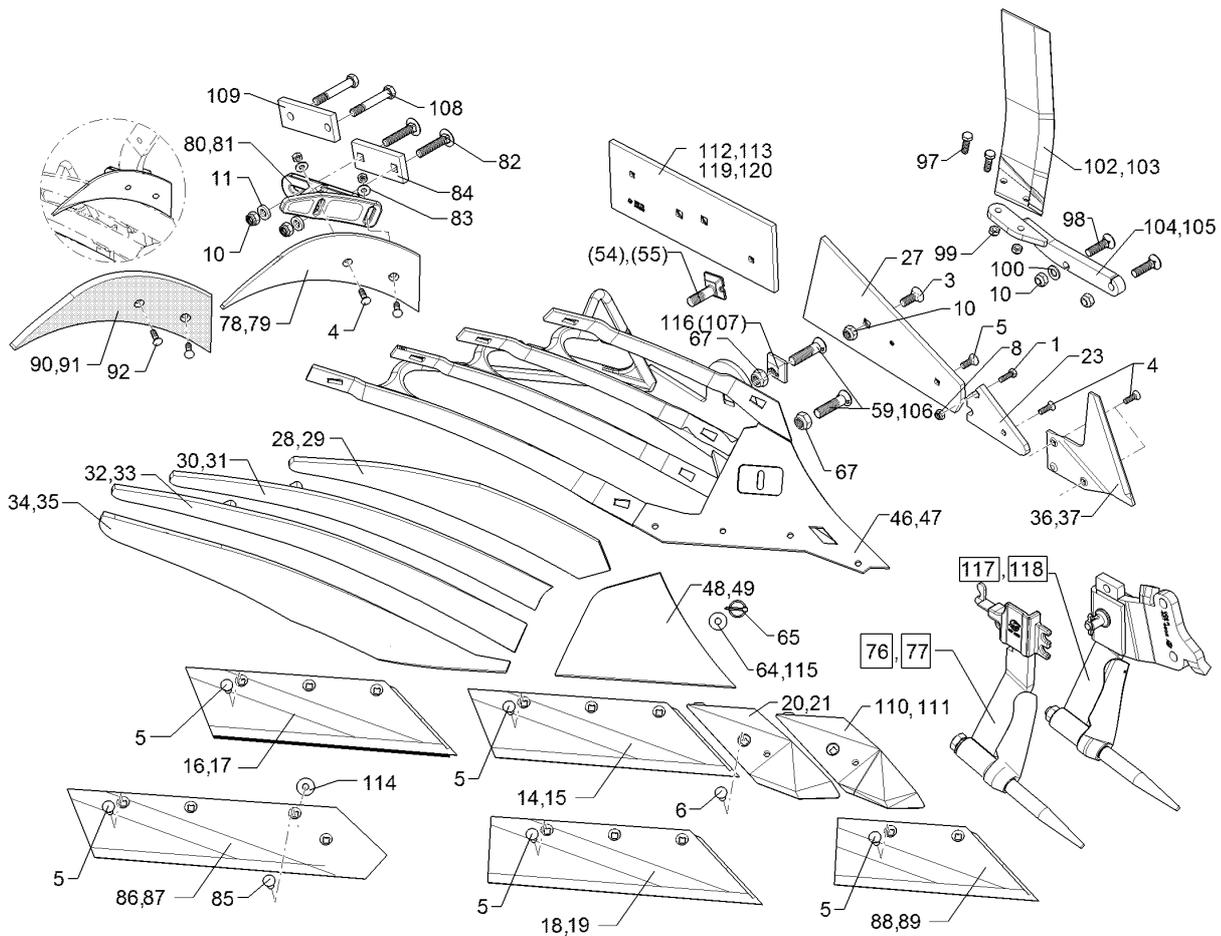

01.18

Pos.	Art.Nr.	Stck.	Artikeltext / Description		Abmessung
29	344 4421	1	Streichblechstreifen	Mouldboard slat	1 DMCS50 LI
30	344 4430	1	Streichblechstreifen	Mouldboard slat	2 DMCS50 RE
31	344 4431	1	Streichblechstreifen	Mouldboard slat	2 DMCS50 LI
32	344 4440	1	Streichblechstreifen	Mouldboard slat	3 DMCS50 RE
33	344 4441	1	Streichblechstreifen	Mouldboard slat	3 DMCS50 LI
34	344 4448	1	Streichblechstreifen	Mouldboard slat	4 DMCS40 RE
35	344 4449	1	Streichblechstreifen	Mouldboard slat	4 DMCS40 LI
36	349 2890	1	Anlagesech	Sword coulter	AS2 RE 6x238x240
37	349 2891	1	Anlagesech	Sword coulter	AS2 LI 6x238x240
46	467 1040	1	Körperrumpf	Frog	DMCS RE
47	467 1041	1	Körperrumpf	Frog	DMCS LI
48	345 1030	1	Streichblechkante	Shin	DMCK RE
49	345 1031	1	Streichblechkante	Shin	DMCK LI
54	301 5780	1	Exzentrerschraube	Eccentric screw	M20x75-12.9 R Zn
55	301 5781	1	Exzentrerschraube	Eccentric screw	M20x75-12.9 L Zn
59	301 5747	1	Senkschraube	Countersunk bolt	M20x70x8,5-12.9 Zn
64	30510060	1	Scheibe	Washer	13/35x5±0,2 Zn
65	311 9568	1	Sicherheitsklappstecker	Securing pin	5x32 d1=4,7 Zn
67	303 0936	2	Sicherungsmutter	Selflocking nut	NM20-8 Zn DIN985
76	657 4612	1	Untergrunddorn	Subsoiler	DMUD-1 RE
77	657 4613	1	Untergrunddorn	Subsoiler	DMUD-1 LI
78	347 0860	1	Einlegehand	Trashboard	E4 RE
79	347 0861	1	Einlegehand	Trashboard	E4 LI

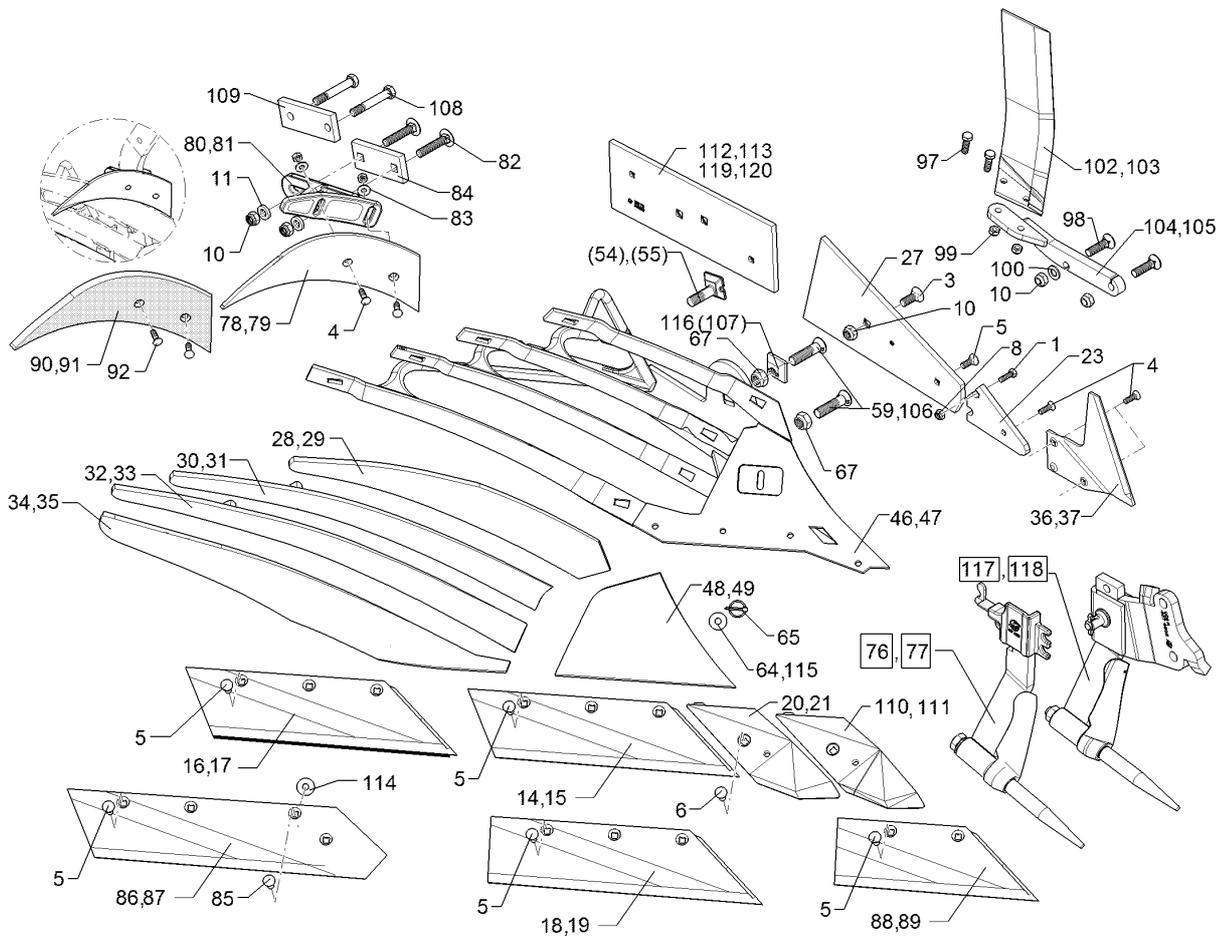

01.18

Pos.	Art.Nr.	Stck.	Artikeltext / Description		Abmessung
80	457 5218	1	Halter	Holder	DM1 E4 RE
81	457 5219	1	Halter	Holder	DM1 E4 LI
82	30110262	2	Flachrundschaube	Saucer-head screw	M16x90-10.9 DIN603 Zn
83	305 6132	2	Scheibe	Washer	D11/25x2,5 Zn
84	459 1194	1	Brücke	Clamp plate	60x15x138 1x97-4Kt17
85	301 5794	1	Senkschraube	Countersunk bolt	M12x45-12.9-MU-10 DIN608 Zn
86	333 5032	1	Steinschar	Share	S42A RE 670x150x11
87	333 5033	1	Steinschar	Share	S42A LI 670x150x11
88	335 2120	1	Scharblatt	Wing	SB43D RE 428x150x11
89	335 2121	1	Scharblatt	Wing	SB43D LI 428x150x11
90	347 0862	1	Einlegehand	Trashboard	E4KU RE
91	347 0863	1	Einlegehand	Trashboard	E4KU LI
92	301 5769	1	Senkschraube	Countersunk bolt	M10x45-12.9-MU-10 Zn
97	301 3347	2	Sechskantschraube	Hexagon bolt	M12x40-8.8 Zn DIN933
98	301 6147	2	Senkschraube spz.	Countersunk bolt	M16x60-10.9 4KT Zn
99	303 0934	2	Sicherungsmutter	Selflocking nut	NM12-8 Zn DIN985
100	305 6141	1	Scheibe	Washer	17/30x3
102	349 2860	1	Breitfurchenmesser	Knife for wide furrows	DIN/ISO-7089 BFM-RE

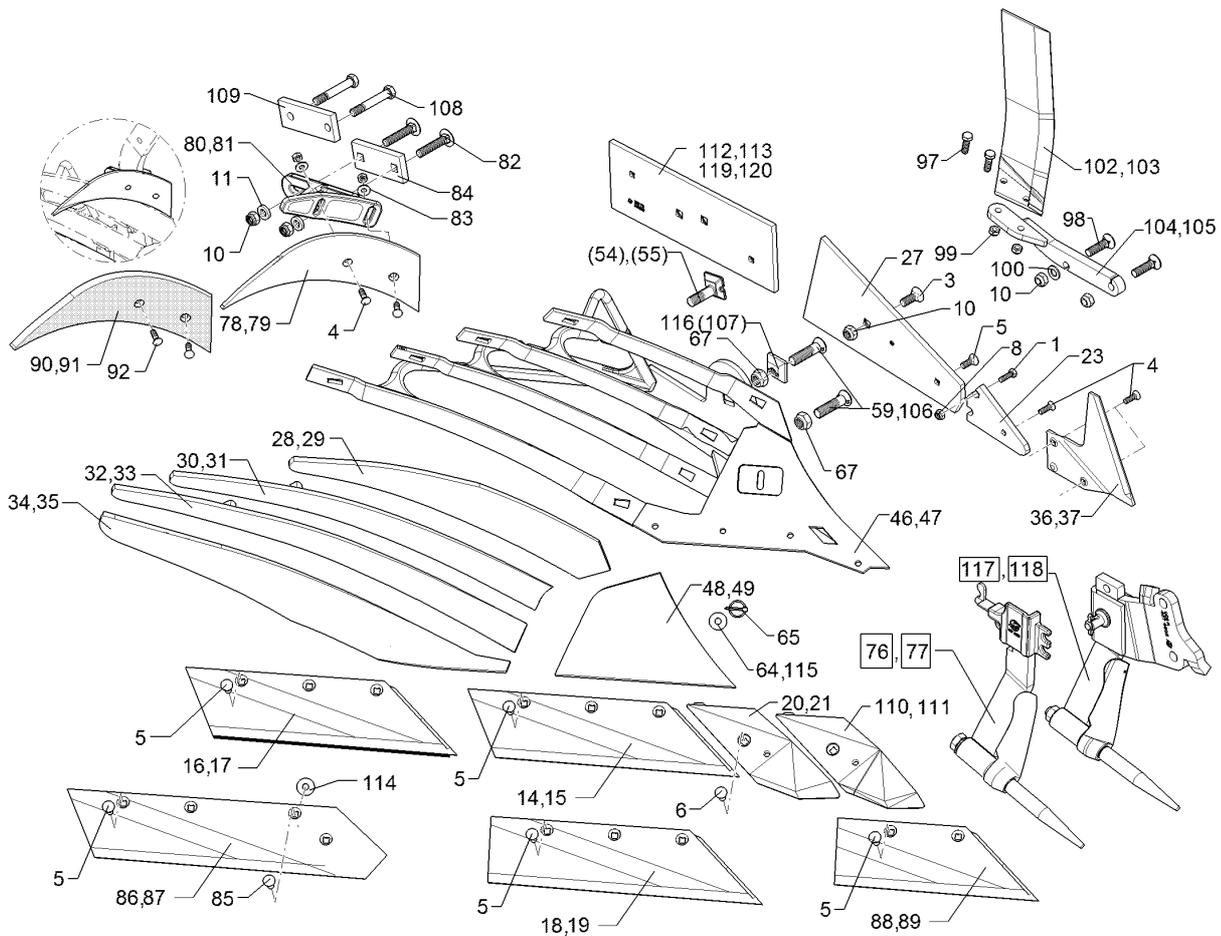

01.18

Pos.	Art.Nr.	Stck.	Artikeltext / Description		Abmessung
103	349 2861	1	Breitfurchenmesser	Knife for wide furrows	BFM-LI
104	45710008	1	Halter	Holder	BFM 3 RE DuraMaxx
105	45710009	1	Halter	Holder	BFM 3 LI DuraMaxx
106	301 5750	1	Senkschraube	Countersunk bolt	M20x80x8,5-12,9 Zn
107	31710028	1	Exzentrerscheibe	Eccentric washer	50x50x16 D20,25 Zn
109	459 1169	1	Brücke	Clamp plate	60x15x152 2xD17-107
110	33610006	1	Scharspitze	Point	SC2PS RE
111	33610007	1	Scharspitze	Point	SC2PS LI
112	34110002	1	Anlage	Landside	DMV2 RE 160x12x460
113	34110003	1	Anlage	Landside	DMV2 LI 160x12x460
114	305 6180	1	Scheibe	Washer	15 DIN7349
115	305 8582	1	Scheibe	Washer	13/32x1,25 St-Zn
116	31710191	1	Exzentrerscheibe	Eccentric washer	50x50x16x2,5 D20,25 Zn
117	657 4608	1	Untergrunddorn	Subsoiler	UD6-80 RE
118	657 4609	1	Untergrunddorn	Subsoiler	UD6-80 LI
119	66710076	1	Anlage mit Schrauben	Landside with bolt	DMV2 RE
120	66710077	1	Anlage mit Schrauben	Landside with bolt	DMV2 LI

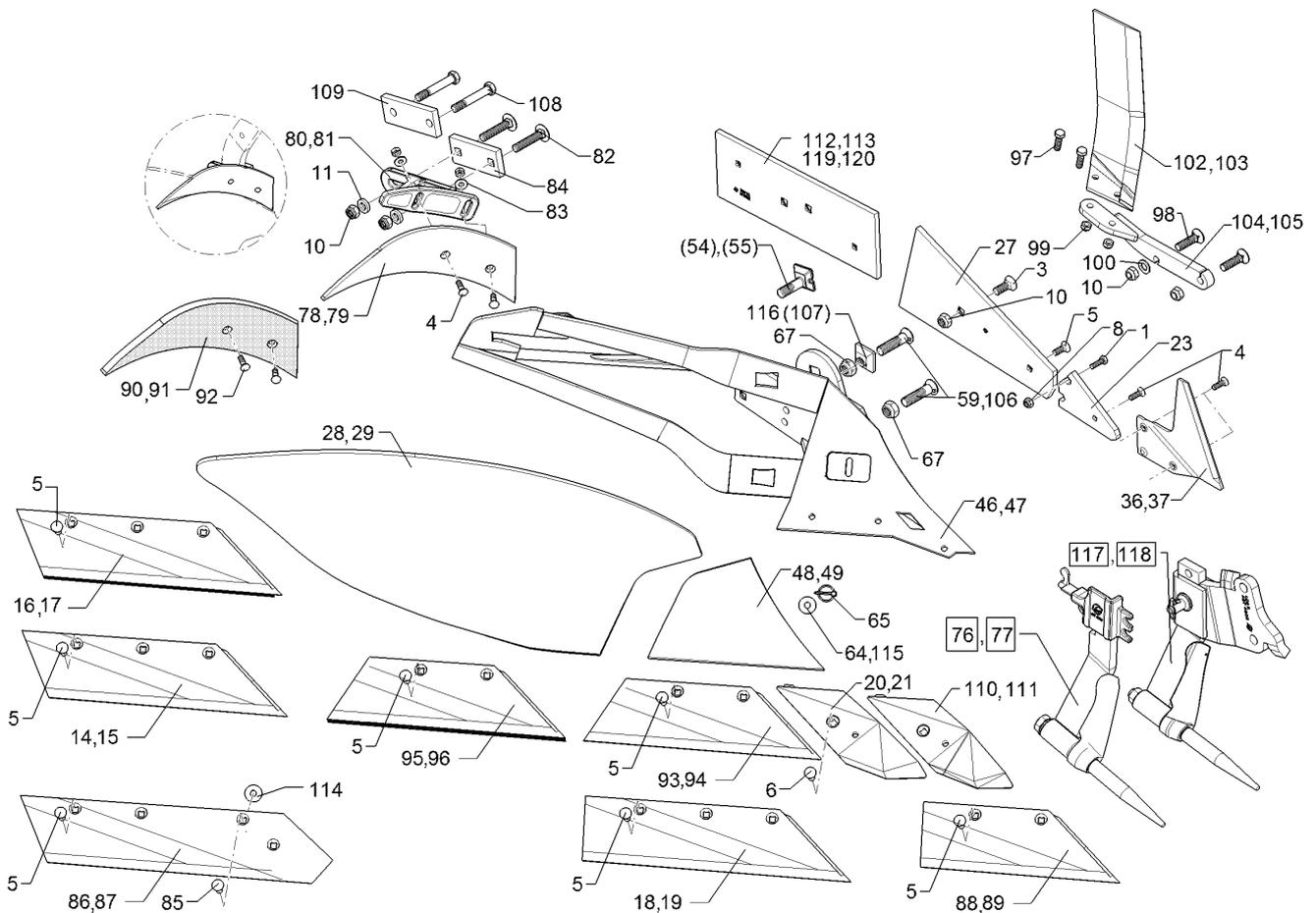

01.18

Pos.	Art.Nr.	Stck.	Artikeltext / Description		Abmessung
1	301 3212	1	Sechskantschraube	Hexagon bolt	M10x25-8.8 Zn DIN933
3	301 6142	1	Senkschraube ohne Mutter	Countersunk bolt	M16x40-10.9 4KT Zn
4	301 5767	2	Senkschraube	Countersunk bolt	M10x33-12.9-MU-10 Zn
5	301 5785	1	Senkschraube	Countersunk bolt	M12x33-12.9-MU-10 Zn
6	301 5789	1	Senkschraube	Countersunk bolt	M12x36x4-12.9-MU-10 Zn
8	303 0933	1	Sicherungsmutter	Selflocking nut	NM10-8 DIN985 Zn
10	303 0935	2	Sicherungsmutter	Selflocking nut	NM16-8 Zn DIN985
11	305 6161	2	Scheibe	Washer	17/40x6 DIN7349 Zn
14	335 2134	1	Scharblatt	Wing	SB56D RE 558x150x11
15	335 2135	1	Scharblatt	Wing	SB56D LI 558x150x11
16	335 2234	1	Scharblatt	Wing	SB56P RE 558x150x11
17	335 2235	1	Scharblatt	Wing	SB56P LI 558x150x11
18	335 2138	1	Scharblatt	Wing	SB58D RE
19	335 2139	1	Scharblatt	Wing	SB58D LI
20	336 4156	1	Scharspitze gepanzert	Point	SC2P RE
21	336 4157	1	Scharspitze gepanzert	Point	SC2P LI
23	340 1903	1	Anlagekeil	Landside wedge	AK12W 12x103x170
27	341 1525	1	Anlage	Landside	DMV1
28	344 2100	1	Streichblechblatt	Mouldboard	DMW40 RE

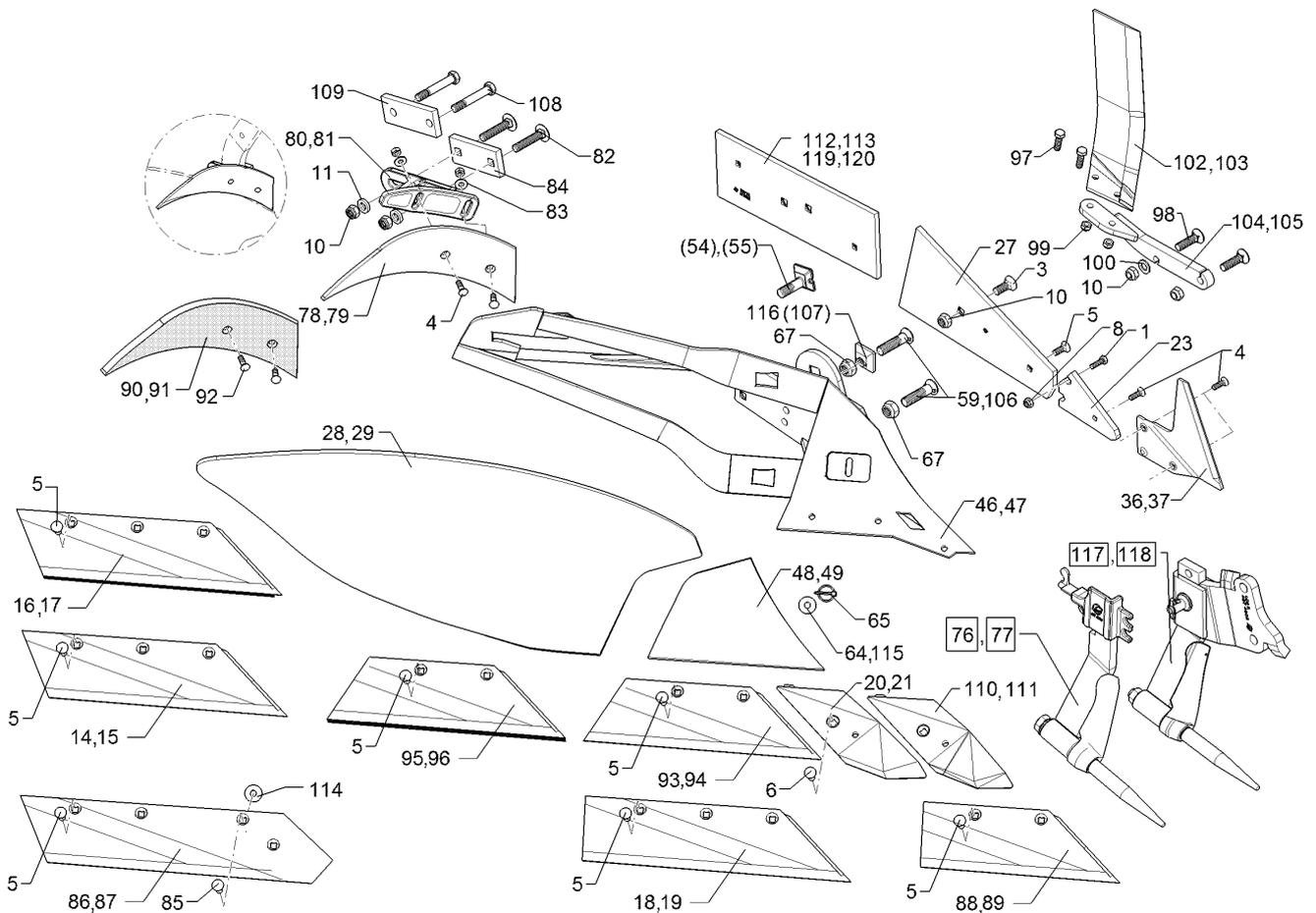

01.18

Pos.	Art.Nr.	Stck.	Artikeltext / Description		Abmessung
29	344 2101	1	Streichblechblatt	Mouldboard	DMW40 LI
36	349 2890	1	Anlagesech	Sword coulter	AS2 RE 6x238x240
37	349 2891	1	Anlagesech	Sword coulter	AS2 LI 6x238x240
46	467 1046	1	Körperrumpf	Frog	DMW RE
47	467 1047	1	Körperrumpf	Frog	DMW LI
48	345 1030	1	Streichblechkante	Shin	DMCK RE
49	345 1031	1	Streichblechkante	Shin	DMCK LI
54	301 5780	1	Exzentrerschraube	Eccentric screw	M20x75-12.9 R Zn
55	301 5781	1	Exzentrerschraube	Eccentric screw	M20x75-12.9 L Zn
59	301 5747	1	Senkschraube	Countersunk bolt	M20x70x8,5-12.9 Zn
64	30510060	1	Scheibe	Washer	13/35x5±0,2 Zn
65	31110015	1	Sicherheitsklappstecker	Securing pin	5x32 d1=4,5 Zn
67	303 0936	2	Sicherungsmutter	Selflocking nut	NM20-8 Zn DIN985
76	657 4612	1	Untergrunddorn	Subsoiler	DMUD-1 RE
77	657 4613	1	Untergrunddorn	Subsoiler	DMUD-1 LI
78	347 0860	1	Einlegehand	Trashboard	E4 RE
79	347 0861	1	Einlegehand	Trashboard	E4 LI
80	457 5218	1	Halter	Holder	DM1 E4 RE
81	457 5219	1	Halter	Holder	DM1 E4 LI
82	30110262	2	Flachrundschrabe	Saucer-head screw	M16x90-10.9 DIN603 Zn
83	305 6132	2	Scheibe	Washer	D11/25x2,5 Zn
84	459 1194	1	Brücke	Clamp plate	60x15x138 1x97-4Kt17

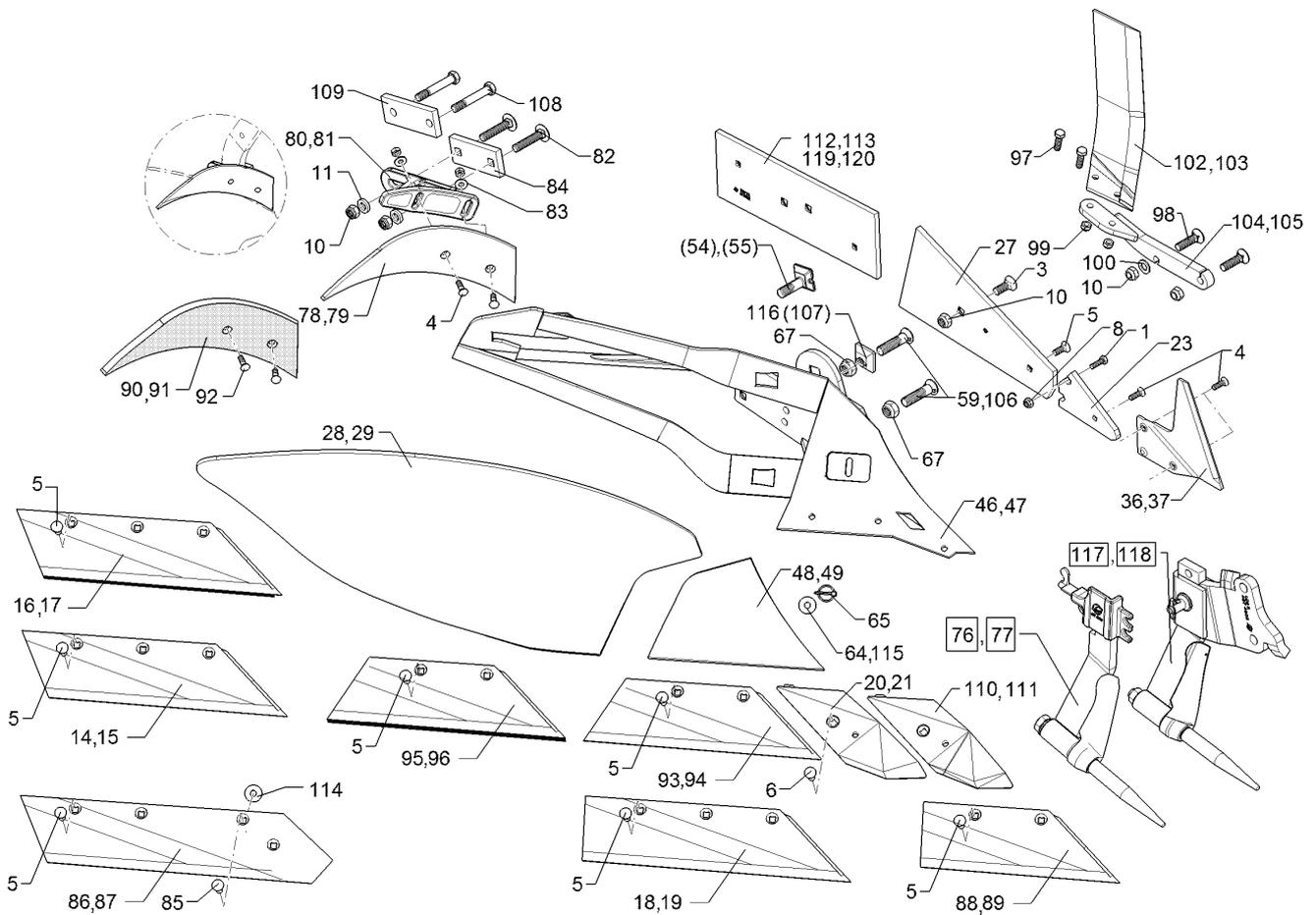

01.18

Pos.	Art.Nr.	Stck.	Artikeltext / Description		Abmessung
85	301 5794	1	Senkschraube	Countersunk bolt	M12x45-12.9-MU-10 DIN608 Zn
86	333 5032	1	Steinschar	Share	S42A RE 670x150x11
87	333 5033	1	Steinschar	Share	S42A LI 670x150x11
88	335 2120	1	Scharblatt	Wing	SB43D RE 428x150x11
89	335 2121	1	Scharblatt	Wing	SB43D LI 428x150x11
90	347 0862	1	Einlegehand	Trashboard	E4KU RE
91	347 0863	1	Einlegehand	Trashboard	E4KU LI
92	301 5769	1	Senkschraube	Countersunk bolt	M10x45-12.9-MU-10 Zn
93	335 2130	1	Scharblatt	Wing	SB45D RE 449x150x11
94	335 2131	1	Scharblatt	Wing	SB45D LI 449x150x11
95	335 2230	1	Scharblatt	Wing	SB45P RE 449x150x11
96	335 2231	1	Scharblatt	Wing	SB45P LI 449x150x11
97	301 3347	2	Sechskantschraube	Hexagon bolt	M12x40-8.8 Zn DIN933
98	301 6147	2	Senkschraube spz.	Countersunk bolt	M16x60-10.9 4KT Zn
99	303 0934	2	Sicherungsmutter	Selflocking nut	NM12-8 Zn DIN985
100	305 6141	1	Scheibe	Washer	17/30x3 DIN/ISO-7089
102	349 2860	1	Breitfurchenmesser	Knife for wide furrows	BFM-RE

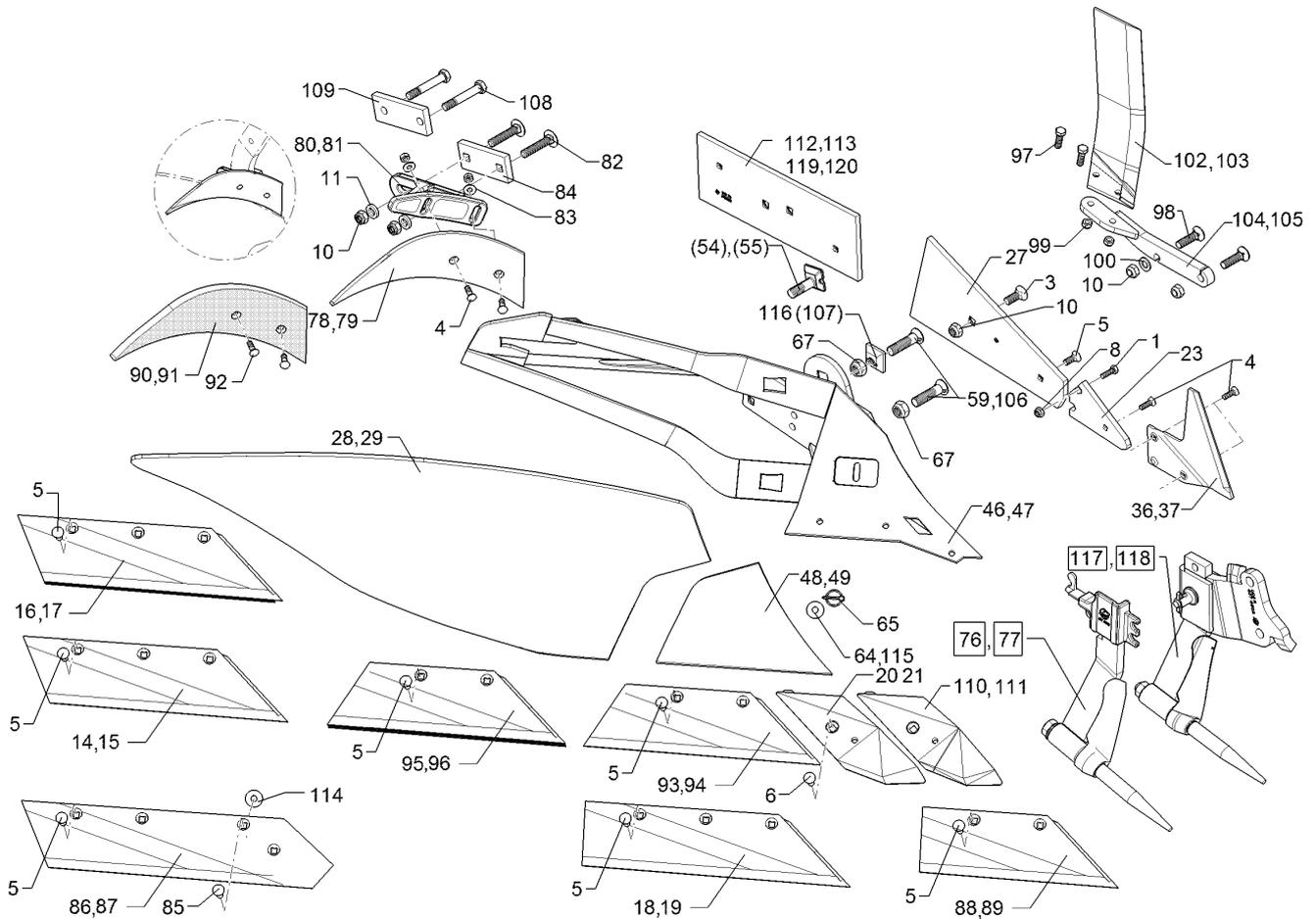

01.18

Pos.	Art.Nr.	Stck.	Artikeltext / Description		Abmessung
1	301 3212	1	Sechskantschraube	Hexagon bolt	M10x25-8.8 Zn DIN933
3	301 6142	1	Senkschraube ohne Mutter	Countersunk bolt	M16x40-10.9 4KT Zn
4	301 5767	2	Senkschraube	Countersunk bolt	M10x33-12.9-MU-10 Zn
5	301 5785	1	Senkschraube	Countersunk bolt	M12x33-12.9-MU-10 Zn
6	301 5789	1	Senkschraube	Countersunk bolt	M12x36x4-12.9-MU-10 Zn
8	303 0933	1	Sicherungsmutter	Selflocking nut	NM10-8 DIN985 Zn
10	303 0935	2	Sicherungsmutter	Selflocking nut	NM16-8 Zn DIN985
11	305 6161	2	Scheibe	Washer	17/40x6 DIN7349 Zn
14	335 2134	1	Scharblatt	Wing	SB56D RE 558x150x11
15	335 2135	1	Scharblatt	Wing	SB56D LI 558x150x11
16	335 2234	1	Scharblatt	Wing	SB56P RE 558x150x11
17	335 2235	1	Scharblatt	Wing	SB56P LI 558x150x11
18	335 2138	1	Scharblatt	Wing	SB58D RE
19	335 2139	1	Scharblatt	Wing	SB58D LI
20	336 4156	1	Scharspitze gepanzert	Point	SC2P RE
21	336 4157	1	Scharspitze gepanzert	Point	SC2P LI
23	340 1903	1	Anlagekeil	Landside wedge	AK12W 12x103x170
27	341 1525	1	Anlage	Landside	DMV1
28	344 2104	1	Streichblechblatt	Mouldboard	DMW52 RE

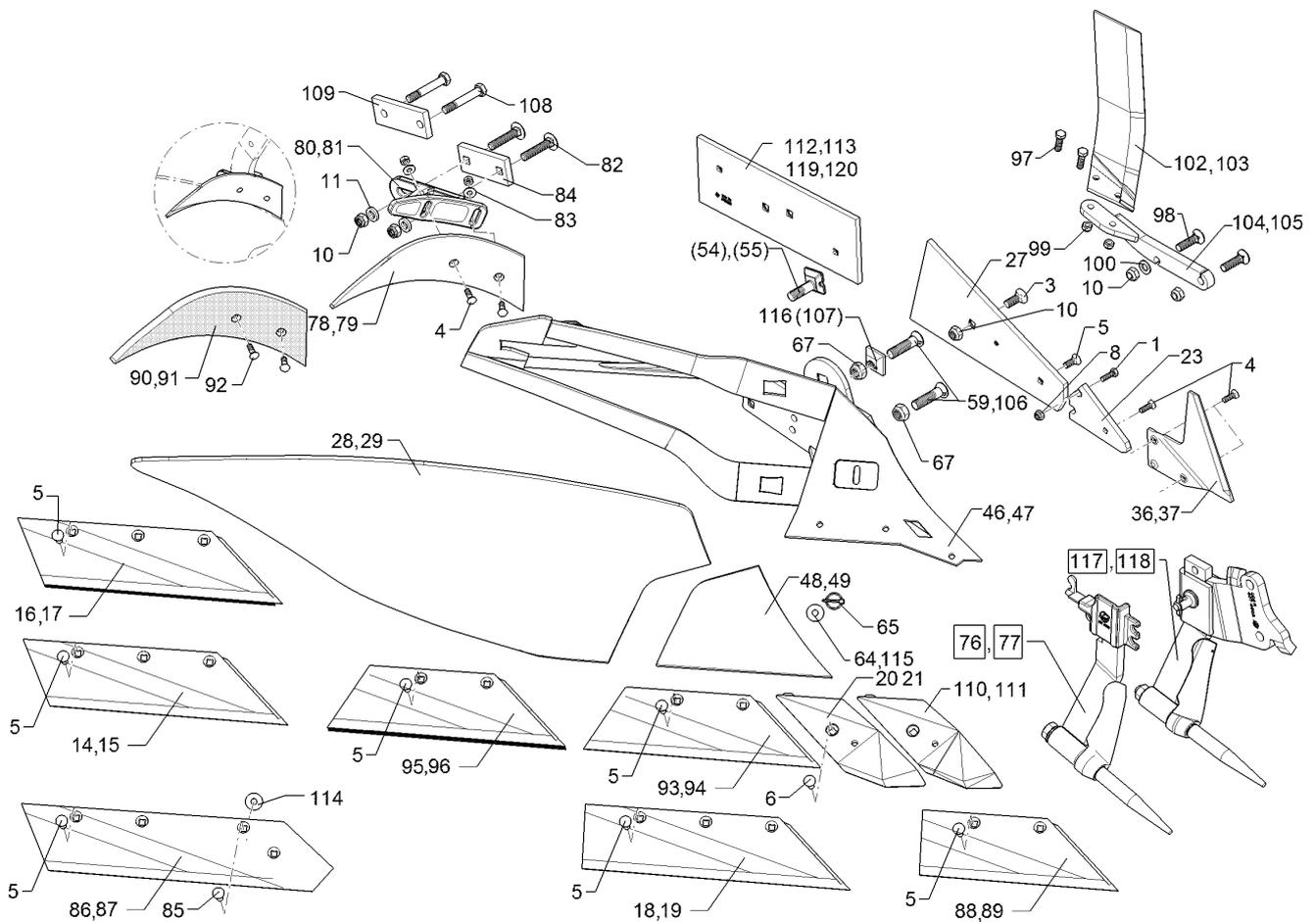

01.18

Pos.	Art.Nr.	Stck.	Artikeltext / Description	Abmessung
29	344 2105	1	Streichblechblatt	DMW52 LI
36	349 2890	1	Anlagesech	AS2 RE 6x238x240
37	349 2891	1	Anlagesech	AS2 LI 6x238x240
46	467 1046	1	Körperrumpf	DMW RE
47	467 1047	1	Körperrumpf	DMW LI
48	345 1030	1	Streichblechkante	DMCK RE
49	345 1031	1	Streichblechkante	DMCK LI
54	301 5780	1	Exzentrerschraube	M20x75-12.9 R Zn
55	301 5781	1	Exzentrerschraube	M20x75-12.9 L Zn
59	301 5747	1	Senkschraube	M20x70x8,5-12.9 Zn
64	30510060	1	Scheibe	13/35x5±0,2 Zn
65	31110015	1	Sicherheitsklappstecker	5x32 d1=4,5 Zn
67	303 0936	2	Sicherungsmutter	NM20-8 Zn DIN985
76	657 4612	1	Untergrunddorn	DMUD-1 RE
77	657 4613	1	Untergrunddorn	DMUD-1 LI
78	347 0860	1	Einlegehand	E4 RE
79	347 0861	1	Einlegehand	E4 LI
80	457 5218	1	Halter	DM1 E4 RE
81	457 5219	1	Halter	DM1 E4 LI
82	30110262	2	Flachrundschrabe	M16x90-10.9 DIN603 Zn
83	305 6132	2	Scheibe	D11/25x2,5 Zn
84	459 1194	1	Brücke	60x15x138 1x97-4Kt17

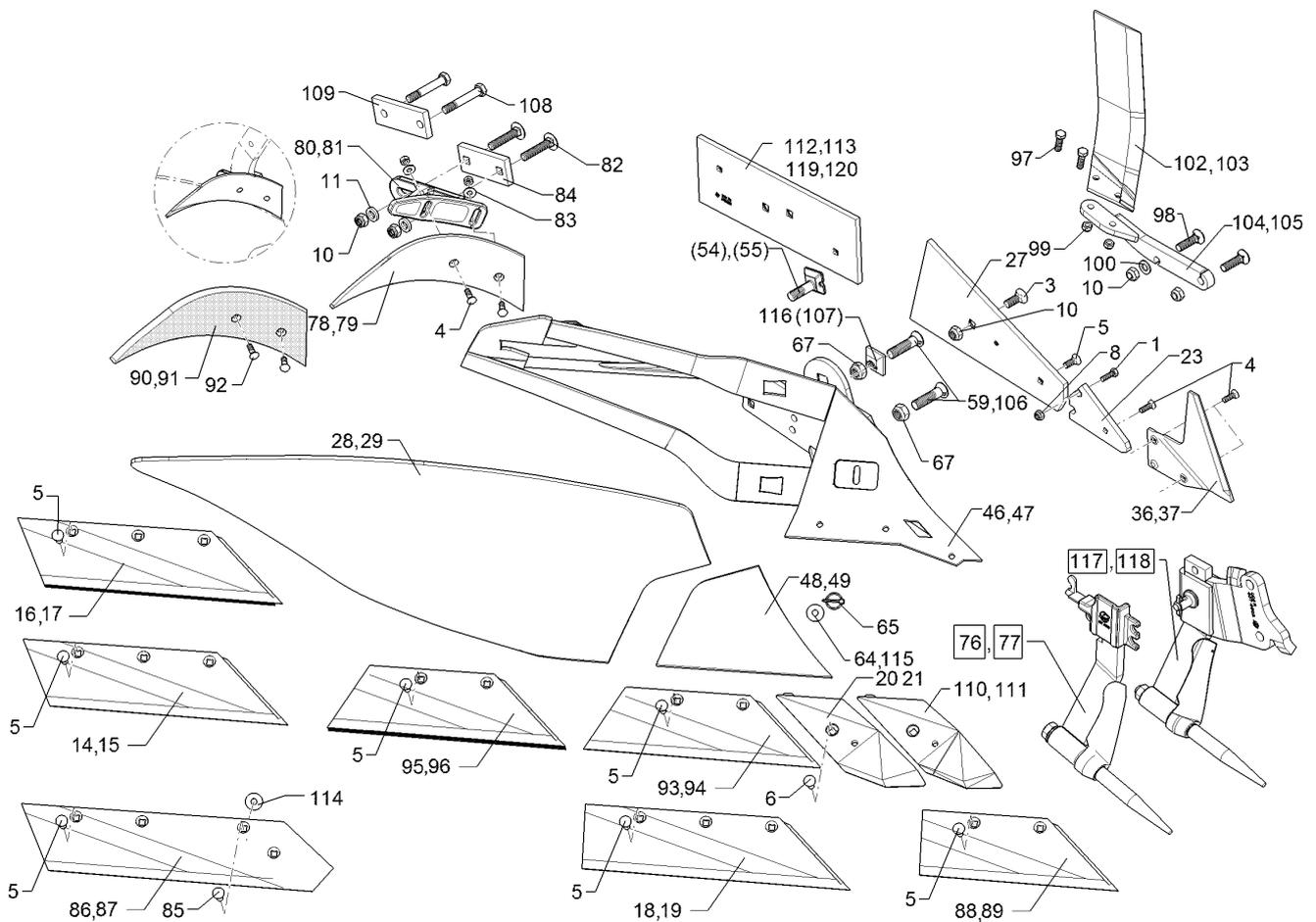

01.18

Pos.	Art.Nr.	Stck.	Artikeltext / Description		Abmessung
85	301 5794	1	Senkschraube	Countersunk bolt	M12x45-12.9-MU-10 DIN608 Zn
86	333 5032	1	Steinschar	Share	S42A RE 670x150x11
87	333 5033	1	Steinschar	Share	S42A LI 670x150x11
88	335 2120	1	Scharblatt	Wing	SB43D RE 428x150x11
89	335 2121	1	Scharblatt	Wing	SB43D LI 428x150x11
90	347 0862	1	Einlegehand	Trashboard	E4KU RE
91	347 0863	1	Einlegehand	Trashboard	E4KU LI
92	301 5769	1	Senkschraube	Countersunk bolt	M10x45-12.9-MU-10 Zn
93	335 2130	1	Scharblatt	Wing	SB45D RE 449x150x11
94	335 2131	1	Scharblatt	Wing	SB45D LI 449x150x11
95	335 2230	1	Scharblatt	Wing	SB45P RE 449x150x11
96	335 2231	1	Scharblatt	Wing	SB45P LI 449x150x11
97	301 3347	2	Sechskantschraube	Hexagon bolt	M12x40-8.8 Zn DIN933
98	301 6147	2	Senkschraube spz.	Countersunk bolt	M16x60-10.9 4KT Zn
99	303 0934	2	Sicherungsmutter	Selflocking nut	NM12-8 Zn DIN985
100	305 6141	1	Scheibe	Washer	17/30x3 DIN/ISO-7089
102	349 2860	1	Breitfurchenmesser	Knife for wide furrows	BFM-RE

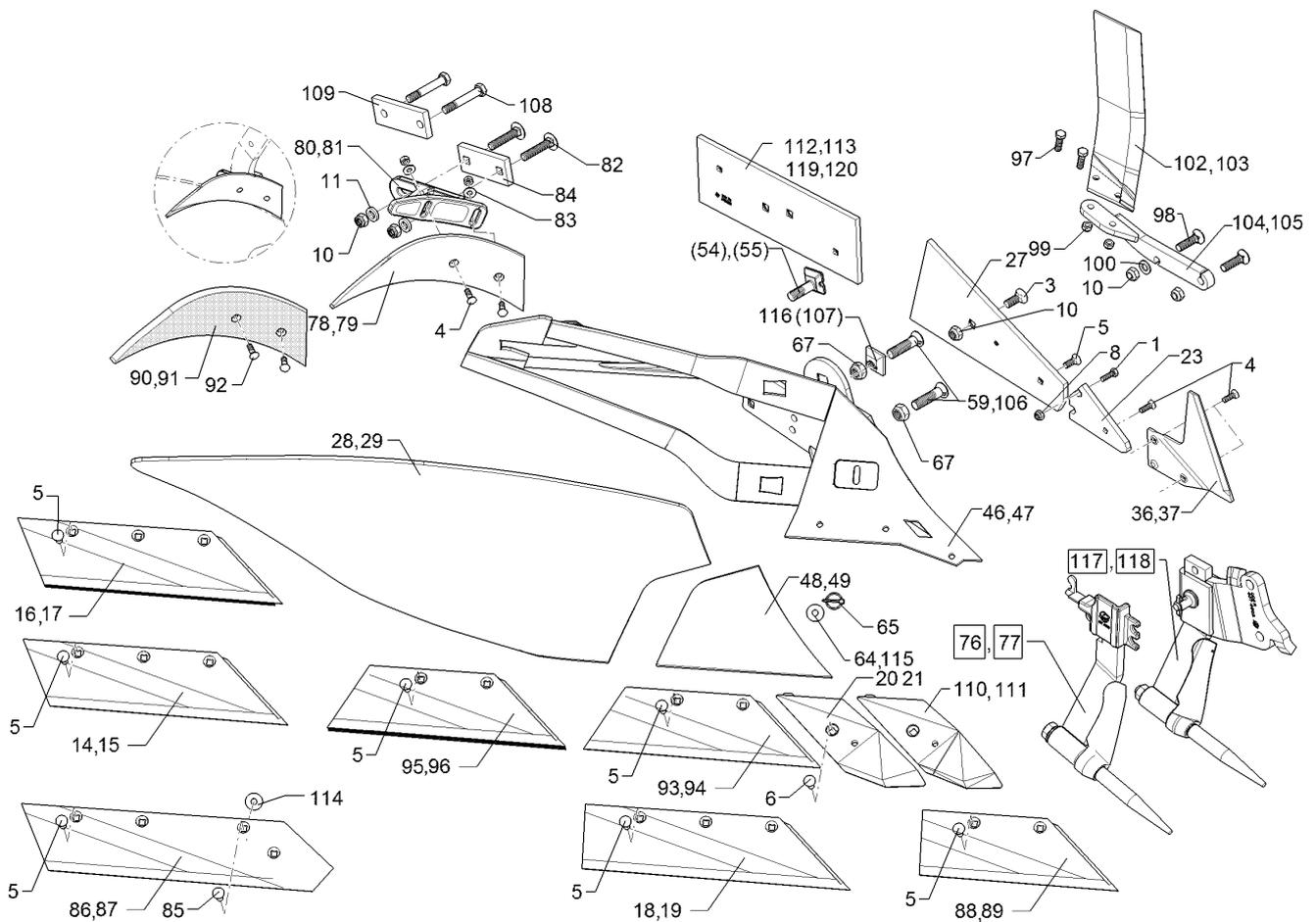

01.18

Pos.	Art.Nr.	Stck.	Artikeltext / Description		Abmessung
103	349 2861	1	Breitfurchenmesser	Knife for wide furrows	BFM-LI
104	45710008	1	Halter	Holder	BFM 3 RE DuraMaxx
105	45710009	1	Halter	Holder	BFM 3 LI DuraMaxx
106	301 5750	1	Senkschraube	Countersunk bolt	M20x80x8,5-12.9 Zn
107	31710028	1	Exzentrerscheibe	Eccentric washer	50x50x16 D20,25 Zn
108	301 3994	2	Sechskantschraube spz.	Hexagon bolt	M16x100-12.9 Zn
109	459 1169	1	Brücke	Clamp plate	60x15x152 2xD17-107
110	33610006	1	Scharspitze	Point	SC2PS RE
111	33610007	1	Scharspitze	Point	SC2PS LI
112	34110002	1	Anlage	Landside	DMV2 RE 160x12x460
113	34110003	1	Anlage	Landside	DMV2 LI 160x12x460
114	305 6180	1	Scheibe	Washer	15 DIN7349
115	305 8582	1	Scheibe	Washer	13/32x1,25 St-Zn
116	31710191	1	Exzentrerscheibe	Eccentric washer	50x50x16x2,5 D20,25 Zn
117	657 4608	1	Untergrunddorn	Subsoiler	UD6-80 RE
118	657 4609	1	Untergrunddorn	Subsoiler	UD6-80 LI
119	66710076	1	Anlage mit Schrauben	Landside with bolt	DMV2 RE
120	66710077	1	Anlage mit Schrauben	Landside with bolt	DMV2 LI

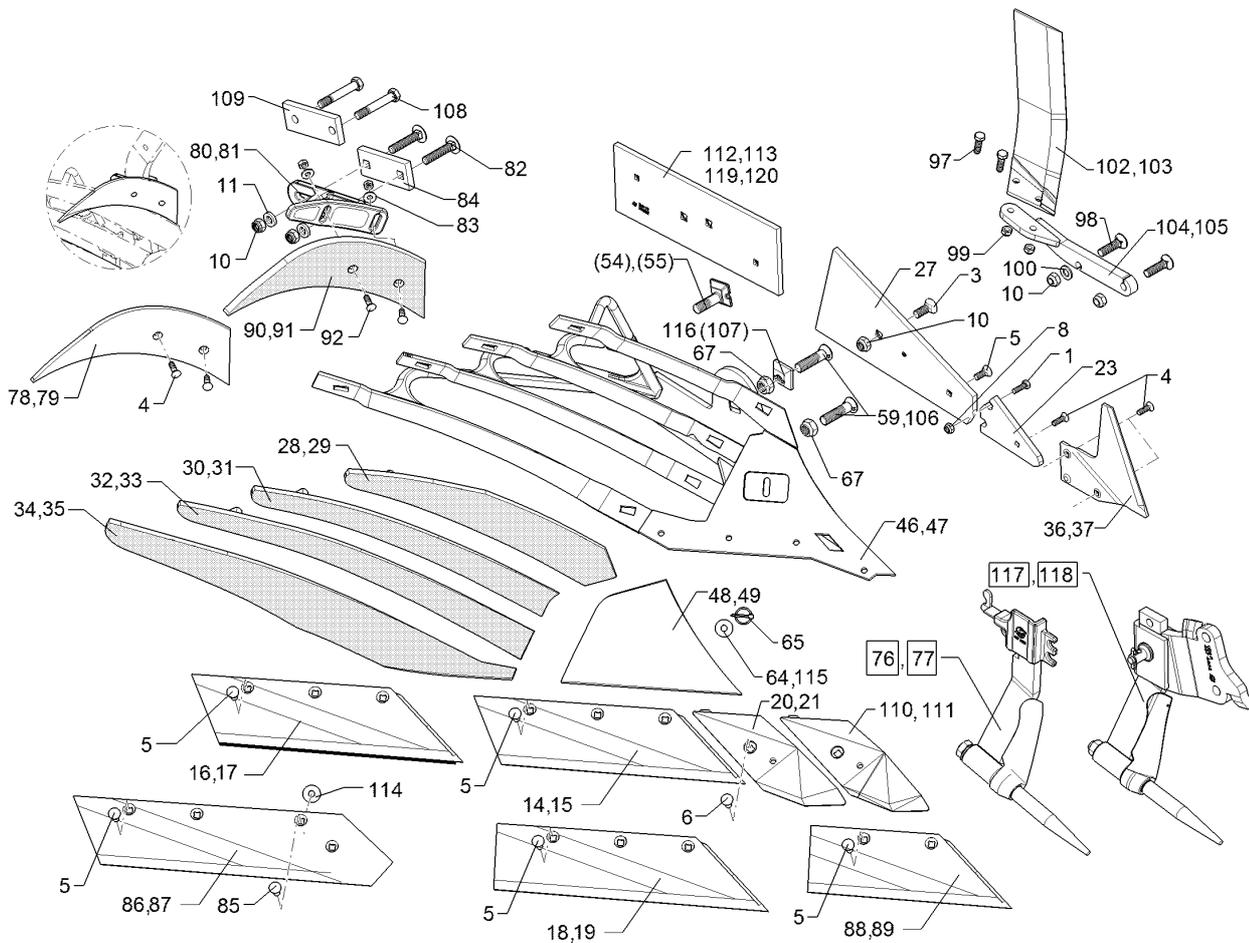

01.18

Pos.	Art.Nr.	Stck.	Artikeltext / Description		Abmessung
1	301 3212	1	Sechskantschraube	Hexagon bolt	M10x25-8.8 Zn DIN933
3	301 6142	1	Senkschraube ohne Mutter	Countersunk bolt	M16x40-10.9 4KT Zn
4	301 5767	2	Senkschraube	Countersunk bolt	M10x33-12.9-MU-10 Zn
5	301 5785	1	Senkschraube	Countersunk bolt	M12x33-12.9-MU-10 Zn
6	301 5789	1	Senkschraube	Countersunk bolt	M12x36x4-12.9-MU-10 Zn
8	303 0933	1	Sicherungsmutter	Selflocking nut	NM10-8 DIN985 Zn
10	303 0935	2	Sicherungsmutter	Selflocking nut	NM16-8 Zn DIN985
11	305 6161	2	Scheibe	Washer	17/40x6 DIN7349 Zn
14	335 2134	1	Scharblatt	Wing	SB56D RE 558x150x11
15	335 2135	1	Scharblatt	Wing	SB56D LI 558x150x11
16	335 2234	1	Scharblatt	Wing	SB56P RE 558x150x11
17	335 2235	1	Scharblatt	Wing	SB56P LI 558x150x11
18	335 2138	1	Scharblatt	Wing	SB58D RE
19	335 2139	1	Scharblatt	Wing	SB58D LI
20	336 4156	1	Scharspitze gepanzert	Point	SC2P RE
21	336 4157	1	Scharspitze gepanzert	Point	SC2P LI
23	340 1903	1	Anlagekeil	Landside wedge	AK12W 12x103x170
27	341 1525	1	Anlage	Landside	DMV1
28	344 0422	1	Streichblech-Streifen	Mouldboard slat	1 DMCS40 KU RE

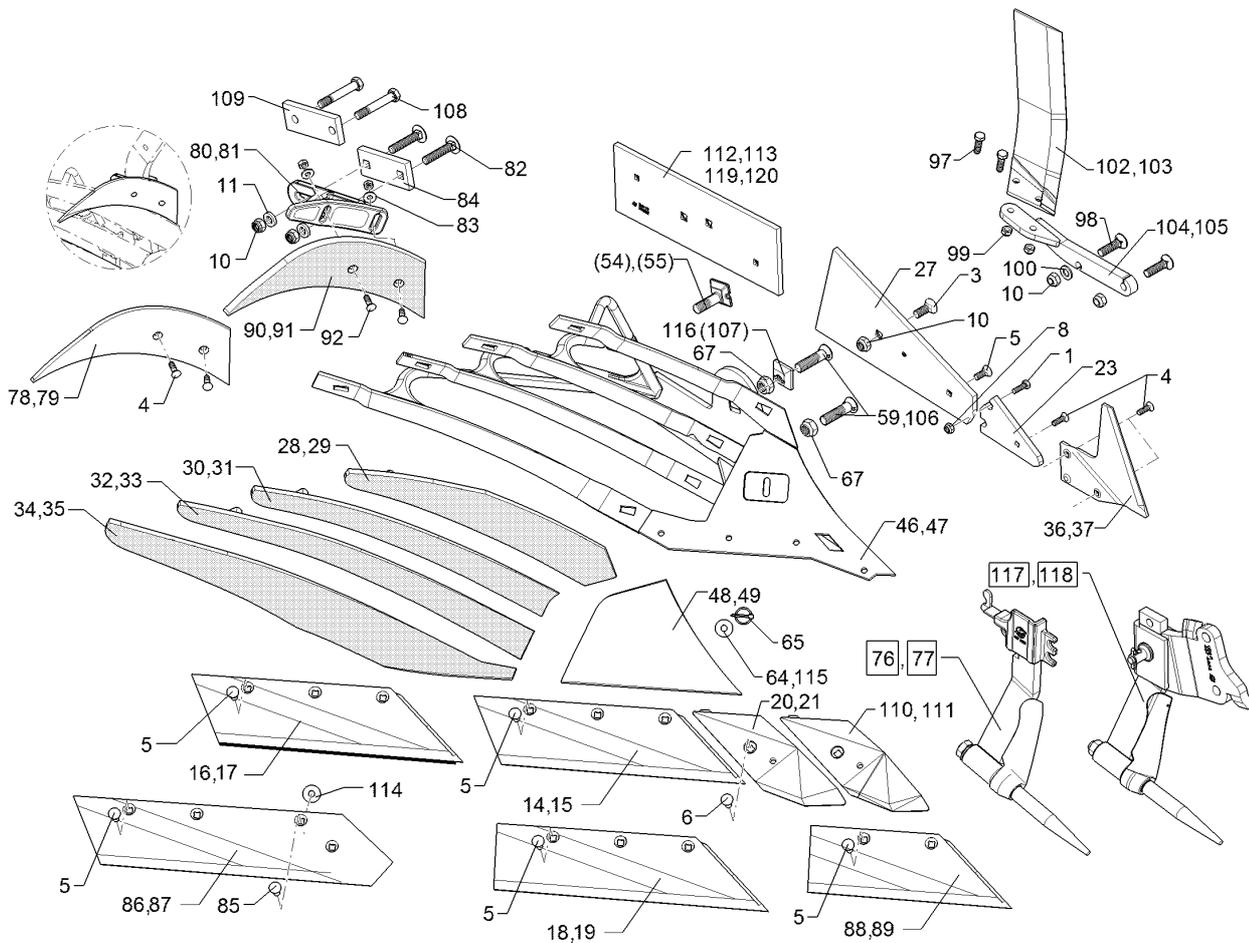

01.18

Pos.	Art.Nr.	Stck.	Artikeltext / Description	Abmessung	
29	344 0423	1	Streichblech-Streifen	Mouldboard slat	1 DMCS40 KU LI
30	344 0432	1	Streichblech-Streifen	Mouldboard slat	2 DMCS40 KU RE
31	344 0433	1	Streichblech-Streifen	Mouldboard slat	2 DMCS40 KU LI
32	344 0442	1	Streichblech-Streifen	Mouldboard slat	3 DMCS40 KU RE
33	344 0443	1	Streichblech-Streifen	Mouldboard slat	3 DMCS40 KU LI
34	344 0452	1	Streichblech-Streifen	Mouldboard slat	4 DMCS40 KU RE
35	344 0453	1	Streichblech-Streifen	Mouldboard slat	4 DMCS40 KU LI
36	349 2890	1	Anlagesech	Sword coulter	AS2 RE 6x238x240
37	349 2891	1	Anlagesech	Sword coulter	AS2 LI 6x238x240
46	467 1040	1	Körperrumpf	Frog	DMCS RE
47	467 1041	1	Körperrumpf	Frog	DMCS LI
48	345 1030	1	Streichblechkante	Shin	DMCK RE
49	345 1031	1	Streichblechkante	Shin	DMCK LI
54	301 5780	1	Exzentrerschraube	Eccentric screw	M20x75-12.9 R Zn
55	301 5781	1	Exzentrerschraube	Eccentric screw	M20x75-12.9 L Zn
59	301 5747	1	Senkschraube	Countersunk bolt	M20x70x8,5-12.9 Zn
64	30510060	1	Scheibe	Washer	13/35x5±0,2 Zn
65	31110015	1	Sicherheitsklappstecker	Securing pin	5x32 d1=4,5 Zn
67	303 0936	2	Sicherungsmutter	Selflocking nut	NM20-8 Zn DIN985
76	657 4612	1	Untergrundorn	Subsoiler	DMUD-1 RE
77	657 4613	1	Untergrundorn	Subsoiler	DMUD-1 LI
78	347 0860	1	Einlegehand	Trashboard	E4 RE
79	347 0861	1	Einlegehand	Trashboard	E4 LI

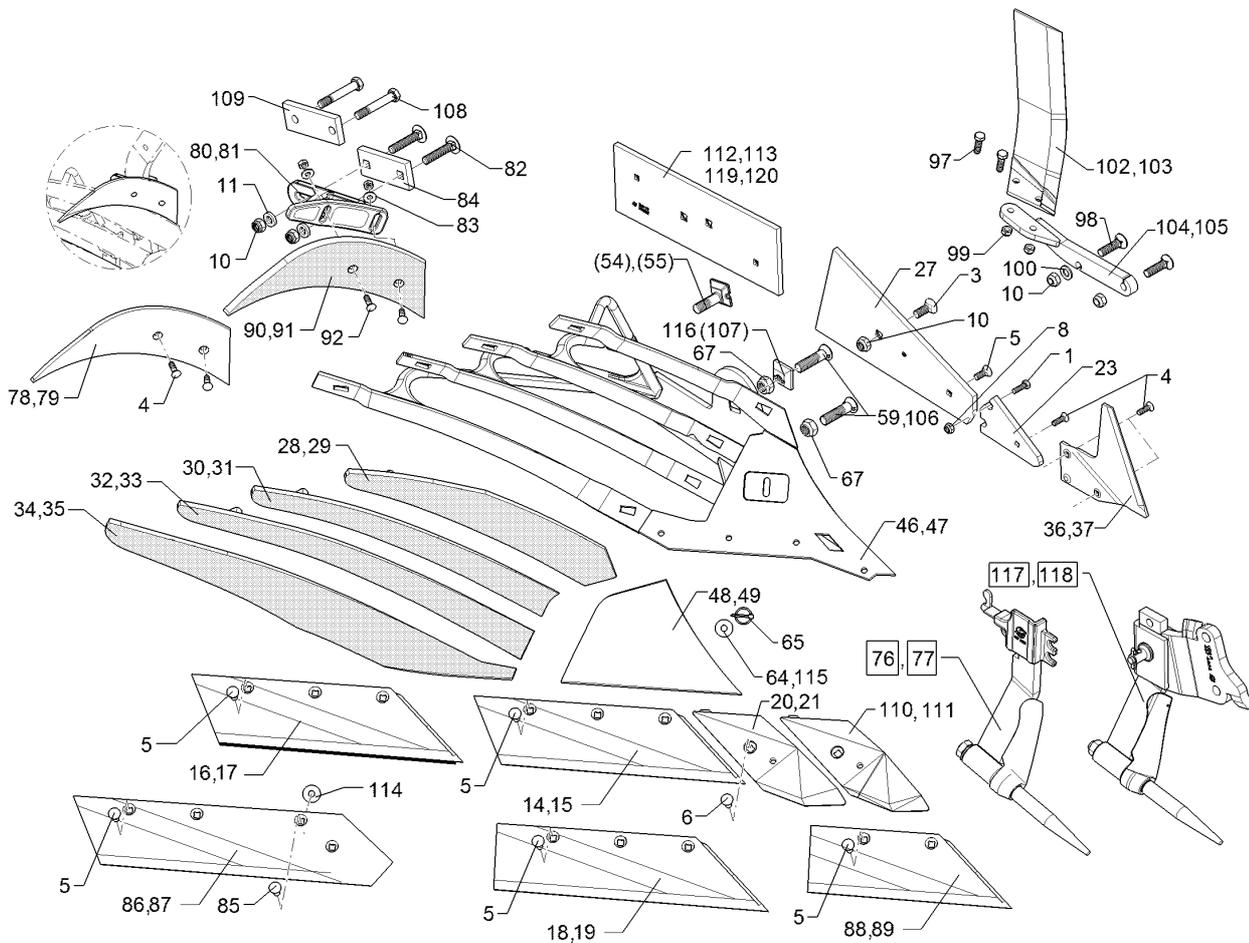

01.18

Pos.	Art.Nr.	Stck.	Artikeltext / Description		Abmessung
80	457 5218	1	Halter	Holder	DM1 E4 RE
81	457 5219	1	Halter	Holder	DM1 E4 LI
82	301 2292	2	Flachrundschraube	Saucer-head screw	M16x80-10.9 Zn
83	305 6132	2	Scheibe	Washer	D11/25x2,5 Zn
84	459 1194	1	Brücke	Clamp plate	60x15x138
85	301 5794	1	Senkschraube	Countersunk bolt	1x97-4Kt17 M12x45-12.9-MU-10 DIN608 Zn
86	333 5032	1	Steinschar	Share	S42A RE
87	333 5033	1	Steinschar	Share	670x150x11 S42A LI 670x150x11
88	335 2120	1	Scharblatt	Wing	SB43D RE
89	335 2121	1	Scharblatt	Wing	428x150x11 SB43D LI 428x150x11
90	347 0862	1	Einlegehand	Trashboard	E4KU RE
91	347 0863	1	Einlegehand	Trashboard	E4KU LI
92	301 5769	1	Senkschraube	Countersunk bolt	M10x45-12.9-MU-10 Zn
97	301 3347	2	Sechskantschraube	Hexagon bolt	M12x40-8.8 Zn DIN933
98	301 6147	2	Senkschraube spz.	Countersunk bolt	M16x60-10.9 4KT Zn
99	303 0934	2	Sicherungsmutter	Selflocking nut	NM12-8 Zn DIN985
100	305 6141	1	Scheibe	Washer	17/30x3 DIN/ISO-7089
102	349 2860	1	Breitfurchenmesser	Knife for wide furrows	BFM-RE
103	349 2861	1	Breitfurchenmesser	Knife for wide furrows	BFM-LI

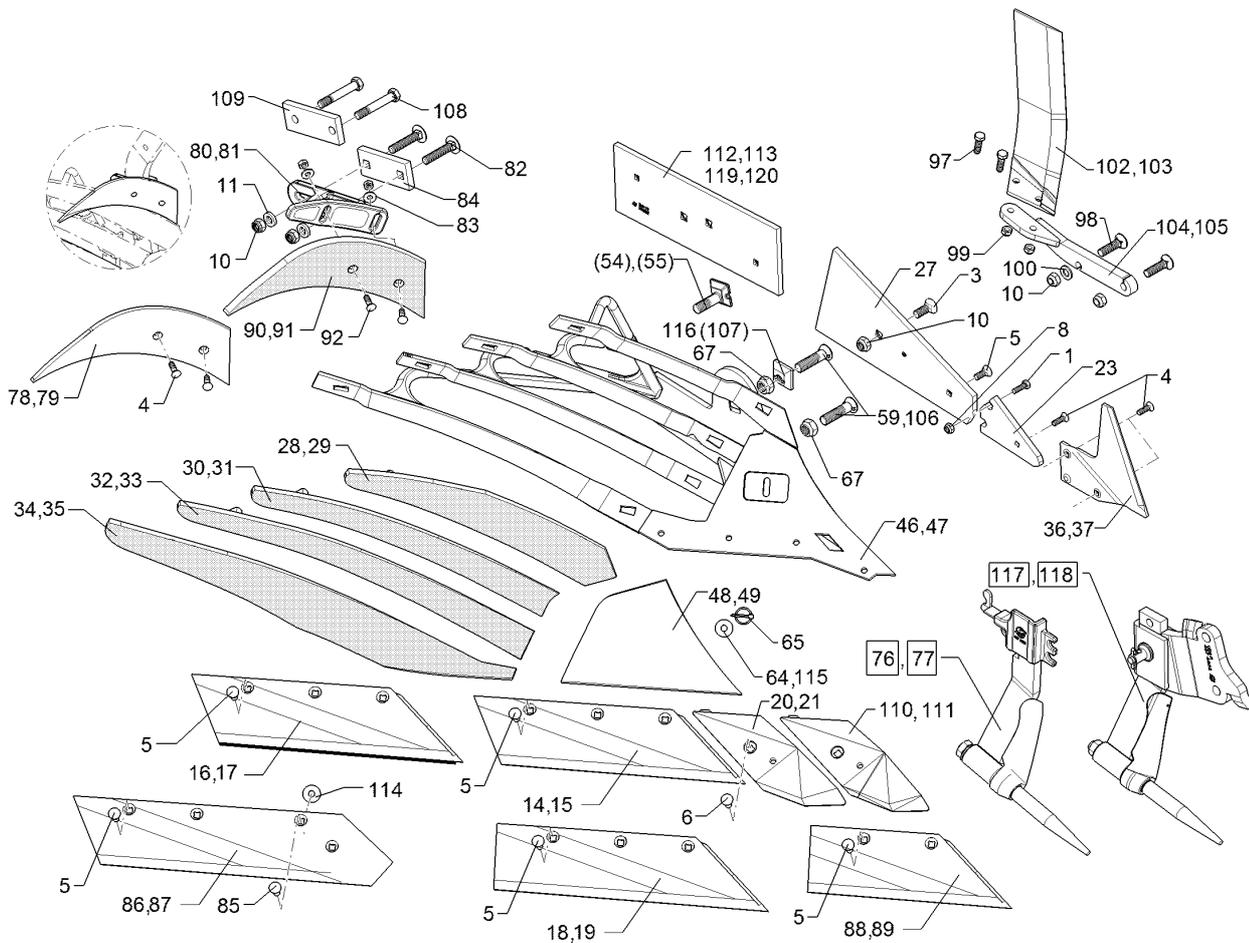

01.18

Pos.	Art.Nr.	Stck.	Artikeltext / Description	Abmessung	
104	45710008	1	Halter	Holder	BFM 3 RE DuraMaxx
105	45710009	1	Halter	Holder	BFM 3 LI DuraMaxx
106	301 5750	1	Senkschraube	Countersunk bolt	M20x80x8,5-12.9 Zn
107	31710028	1	Exzenterscheibe	Eccentric washer	50x50x16 D20,25 Zn
108	301 3994	2	Sechskantschraube spz.	Hexagon bolt	M16x100-12.9 Zn
110	33610006	1	Scharspitze	Point	SC2PS RE
111	33610007	1	Scharspitze	Point	SC2PS LI
112	34110002	1	Anlage	Landside	DMV2 RE 160x12x460
113	34110003	1	Anlage	Landside	DMV2 LI 160x12x460
114	305 6180	1	Scheibe	Washer	15 DIN7349
115	305 8582	1	Scheibe	Washer	13/32x1,25 St-Zn
116	31710191	1	Exzenterscheibe	Eccentric washer	50x50x16x2,5 D20,25 Zn
117	657 4608	1	Untergrunddorn	Subsoiler	UD6-80 RE
118	657 4609	1	Untergrunddorn	Subsoiler	UD6-80 LI
119	66710076	1	Anlage mit Schrauben	Landside with bolt	DMV2 RE
120	66710077	1	Anlage mit Schrauben	Landside with bolt	DMV2 LI

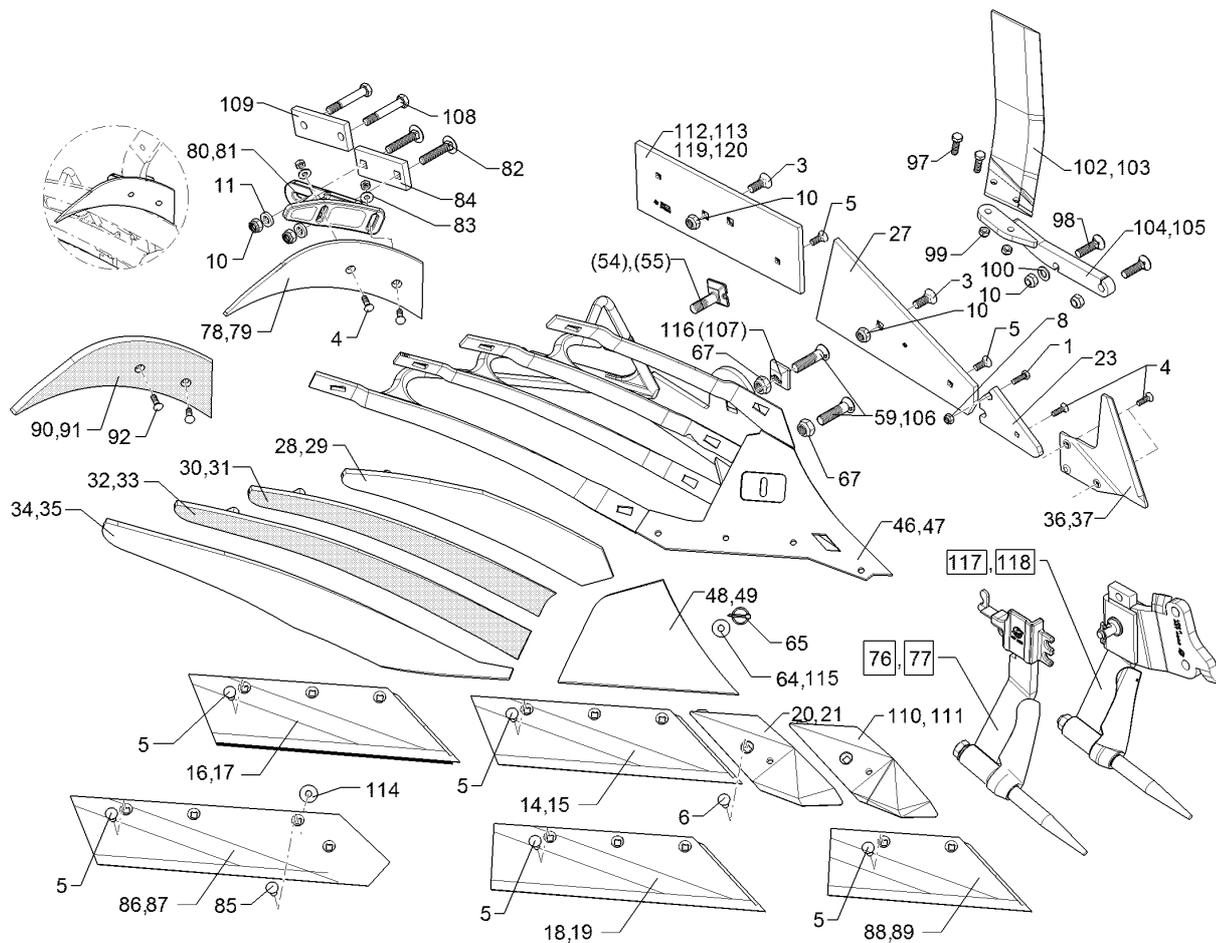

01.18

Pos.	Art.Nr.	Stck.	Artikeltext / Description		Abmessung
1	301 3994	2	Sechskantschraube spz.	Hexagon bolt	M16x100-12.9 Zn
3	301 6142	1	Senkschraube ohne Mutter	Countersunk bolt	M16x40-10.9 4KT Zn
4	301 5767	2	Senkschraube	Countersunk bolt	M10x33-12.9-MU-10 Zn
5	301 5785	1	Senkschraube	Countersunk bolt	M12x33-12.9-MU-10 Zn
6	301 5789	1	Senkschraube	Countersunk bolt	M12x36x4-12.9-MU-10 Zn
8	303 0933	1	Sicherungsmutter	Selflocking nut	NM10-8 DIN985 Zn
10	303 0935	2	Sicherungsmutter	Selflocking nut	NM16-8 Zn DIN985
11	305 6161	2	Scheibe	Washer	17/40x6 DIN7349 Zn
14	335 2134	1	Scharblatt	Wing	SB56D RE 558x150x11
15	335 2135	1	Scharblatt	Wing	SB56D LI 558x150x11
16	335 2234	1	Scharblatt	Wing	SB56P RE 558x150x11
17	335 2235	1	Scharblatt	Wing	SB56P LI 558x150x11
18	335 2138	1	Scharblatt	Wing	SB58D RE
19	335 2139	1	Scharblatt	Wing	SB58D LI
20	336 4156	1	Scharspitze gepanzert	Point	SC2P RE
21	336 4157	1	Scharspitze gepanzert	Point	SC2P LI
23	340 1903	1	Anlagekeil	Landside wedge	AK12W 12x103x170
27	341 1525	1	Anlage	Landside	DMV1
28	344 0422	1	Streichblech-Streifen	Mouldboard slat	1 DMCS40 KU RE

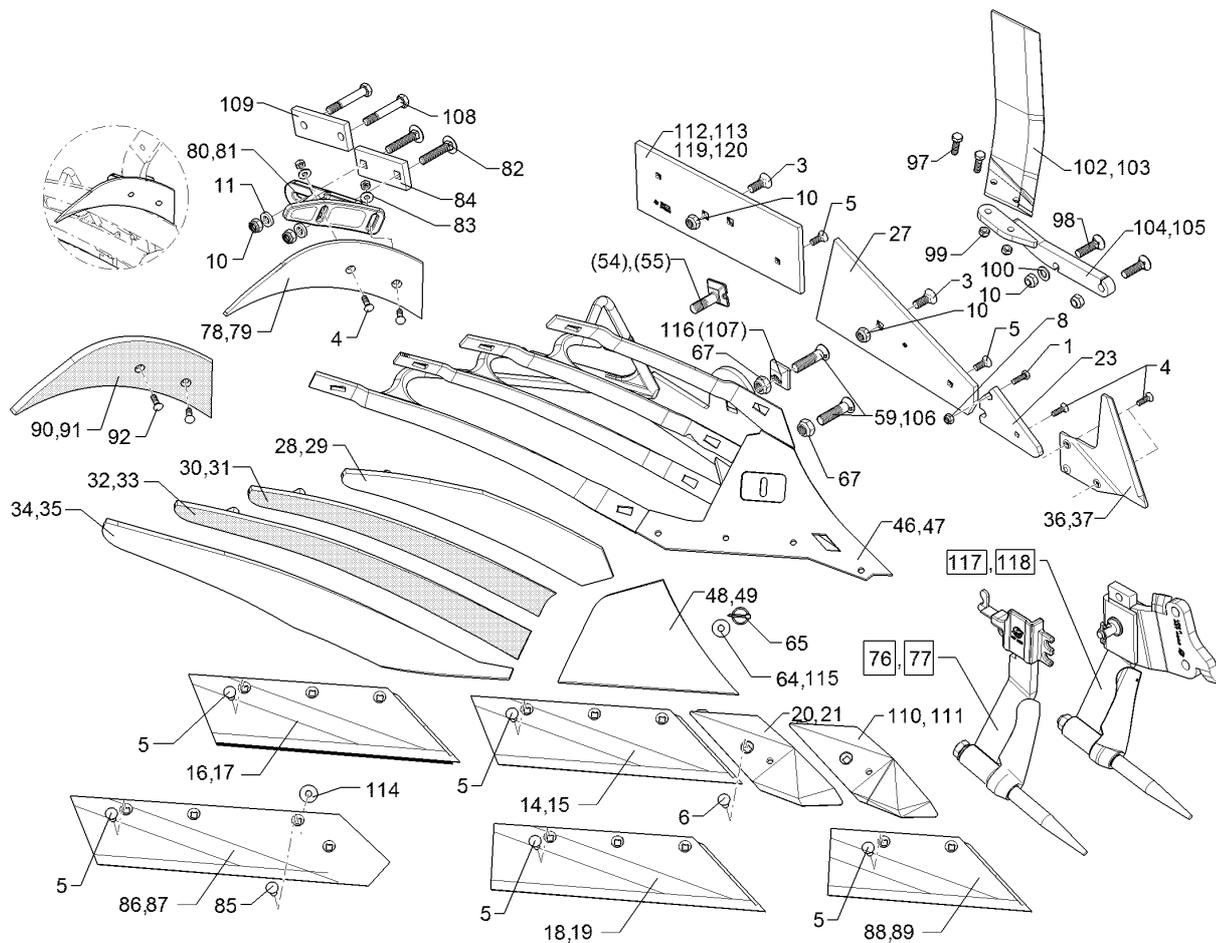

01.18

Pos.	Art.Nr.	Stck.	Artikeltext / Description		Abmessung
29	344 0423	1	Streichblech-Streifen	Mouldboard slat	1 DMCS40 KU LI
30	344 4428	1	Streichblechstreifen	Mouldboard slat	2 DMCS40 RE
31	344 4429	1	Streichblechstreifen	Mouldboard slat	2 DMCS40 LI
32	344 4438	1	Streichblechstreifen	Mouldboard slat	3 DMCS40 RE
33	344 4439	1	Streichblechstreifen	Mouldboard slat	3 DMCS40 LI
34	344 0452	1	Streichblech-Streifen	Mouldboard slat	4 DMCS40 KU RE
35	344 0453	1	Streichblech-Streifen	Mouldboard slat	4 DMCS40 KU LI
36	349 2890	1	Anlagesech	Sword coulter	AS2 RE 6x238x240
37	349 2891	1	Anlagesech	Sword coulter	AS2 LI 6x238x240
46	467 1040	1	Körperrumpf	Frog	DMCS RE
47	467 1041	1	Körperrumpf	Frog	DMCS LI
48	345 1030	1	Streichblechkante	Shin	DMCK RE
49	345 1031	1	Streichblechkante	Shin	DMCK LI
54	301 5780	1	Exzentrerschraube	Eccentric screw	M20x75-12.9 R Zn
55	301 5781	1	Exzentrerschraube	Eccentric screw	M20x75-12.9 L Zn
59	301 5747	1	Senkschraube	Countersunk bolt	M20x70x8,5-12.9 Zn
64	30510060	1	Scheibe	Washer	13/35x5±0,2 Zn
65	31110015	1	Sicherheitsklappstecker	Securing pin	5x32 d1=4,5 Zn
67	303 0936	2	Sicherungsmutter	Selflocking nut	NM20-8 Zn DIN985
76	657 4612	1	Untergrundorn	Subsoiler	DMUD-1 RE
77	657 4613	1	Untergrundorn	Subsoiler	DMUD-1 LI
78	347 0860	1	Einlegehand	Trashboard	E4 RE
79	347 0861	1	Einlegehand	Trashboard	E4 LI

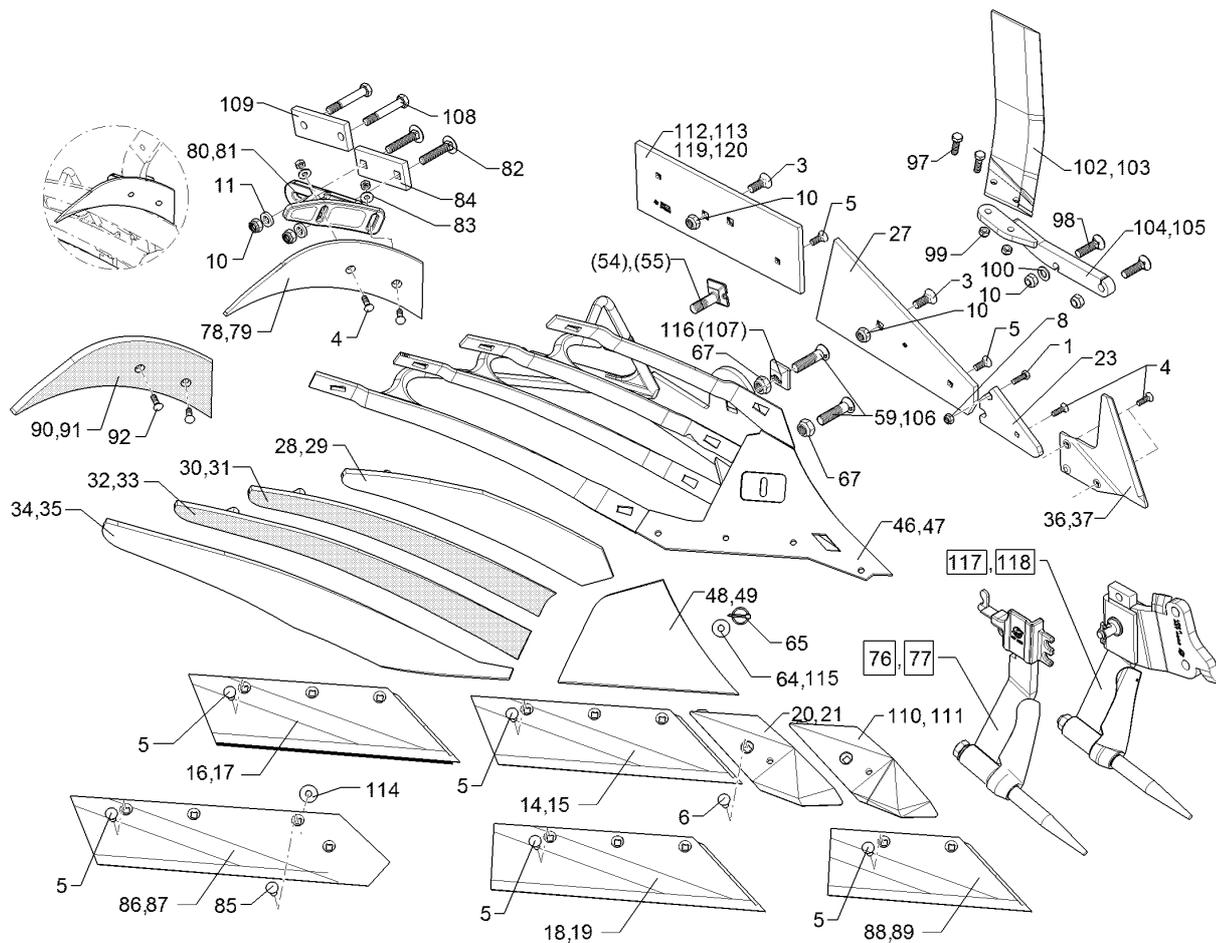

01.18

Pos.	Art.Nr.	Stck.	Artikeltext / Description		Abmessung
80	457 5218	1	Halter	Holder	DM1 E4 RE
81	457 5219	1	Halter	Holder	DM1 E4 LI
82	30110262	2	Flachrundschaube	Saucer-head screw	M16x90-10.9 DIN603 Zn
83	305 6132	2	Scheibe	Washer	D11/25x2,5 Zn
84	459 1194	1	Brücke	Clamp plate	60x15x138 1x97-4Kt17
85	301 5794	1	Senkschraube	Countersunk bolt	M12x45-12.9-MU-10 DIN608 Zn
86	333 5032	1	Steinschar	Share	S42A RE 670x150x11
87	333 5033	1	Steinschar	Share	S42A LI 670x150x11
88	335 2120	1	Scharblatt	Wing	SB43D RE 428x150x11
89	335 2121	1	Scharblatt	Wing	SB43D LI 428x150x11
90	347 0862	1	Einlegehand	Trashboard	E4KU RE
91	347 0863	1	Einlegehand	Trashboard	E4KU LI
92	301 5769	1	Senkschraube	Countersunk bolt	M10x45-12.9-MU-10 Zn
97	301 3347	2	Sechskantschraube	Hexagon bolt	M12x40-8.8 Zn DIN933
98	301 6147	2	Senkschraube spz.	Countersunk bolt	M16x60-10.9 4KT Zn
99	303 0934	2	Sicherungsmutter	Selflocking nut	NM12-8 Zn DIN985
100	305 6141	1	Scheibe	Washer	17/30x3
102	349 2860	1	Breitfurchenmesser	Knife for wide furrows	DIN/ISO-7089 BFM-RE

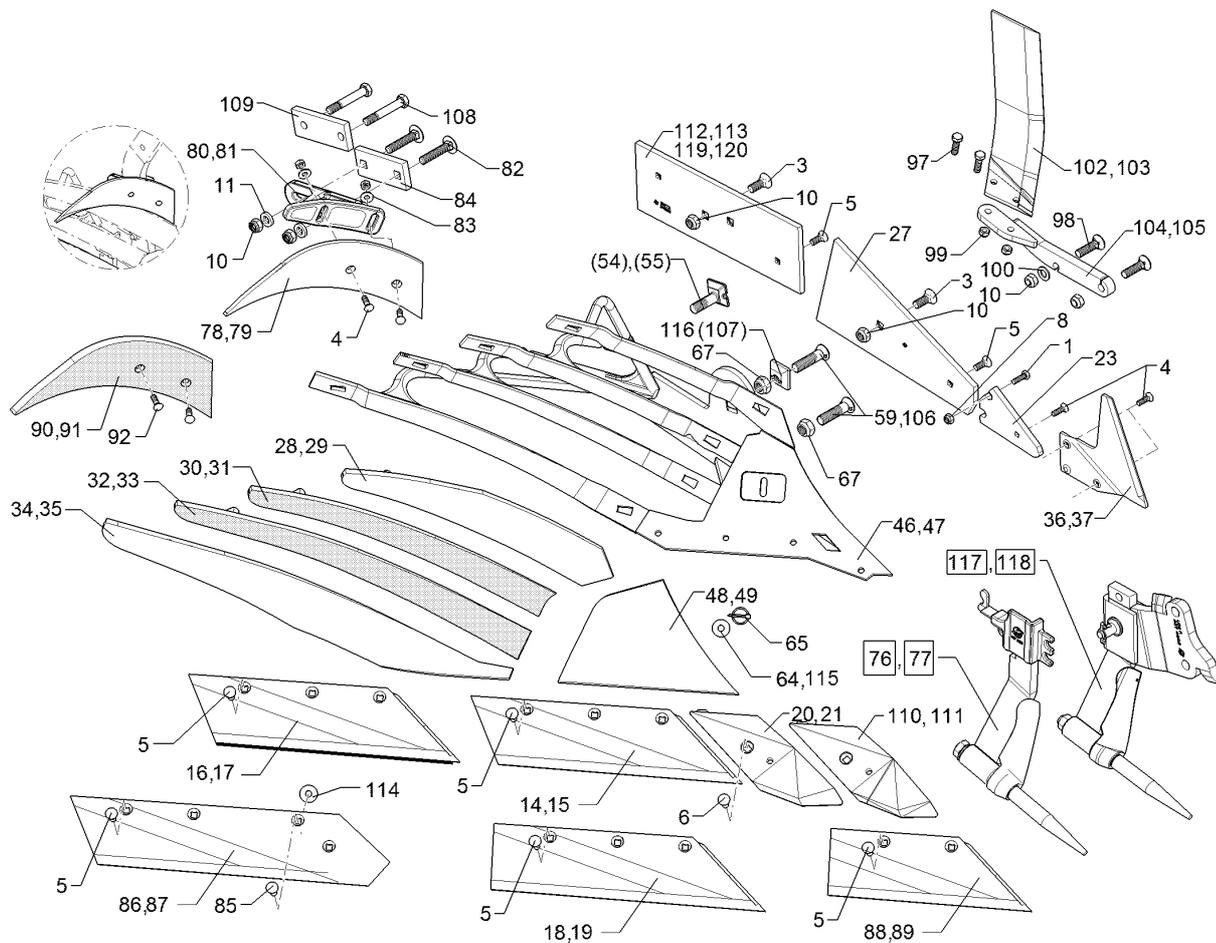

01.18

Pos.	Art.Nr.	Stck.	Artikeltext / Description		Abmessung
103	349 2861	1	Breitfurchenmesser	Knife for wide furrows	BFM-LI
104	45710008	1	Halter	Holder	BFM 3 RE DuraMaxx
105	45710009	1	Halter	Holder	BFM 3 LI DuraMaxx
106	301 5750	1	Senkschraube	Countersunk bolt	M20x80x8,5-12.9 Zn
107	31710028	1	Exzentrerscheibe	Eccentric washer	50x50x16 D20,25 Zn
108	301 3212	1	Sechskantschraube	Hexagon bolt	M10x25-8.8 Zn DIN933
109	459 1169	1	Brücke	Clamp plate	60x15x152 2xD17-107
110	33610006	1	Scharspitze	Point	SC2PS RE
111	33610007	1	Scharspitze	Point	SC2PS LI
112	34110002	1	Anlage	Landside	DMV2 RE 160x12x460
113	34110003	1	Anlage	Landside	DMV2 LI 160x12x460
114	305 6180	1	Scheibe	Washer	15 DIN7349
115	305 8582	1	Scheibe	Washer	13/32x1,25 St-Zn
116	31710191	1	Exzentrerscheibe	Eccentric washer	50x50x16x2,5 D20,25 Zn
117	657 4608	1	Untergrunddorn	Subsoiler	UD6-80 RE
118	657 4609	1	Untergrunddorn	Subsoiler	UD6-80 LI
119	66710076	1	Anlage mit Schrauben	Landside with bolt	DMV2 RE
120	66710077	1	Anlage mit Schrauben	Landside with bolt	DMV2 LI

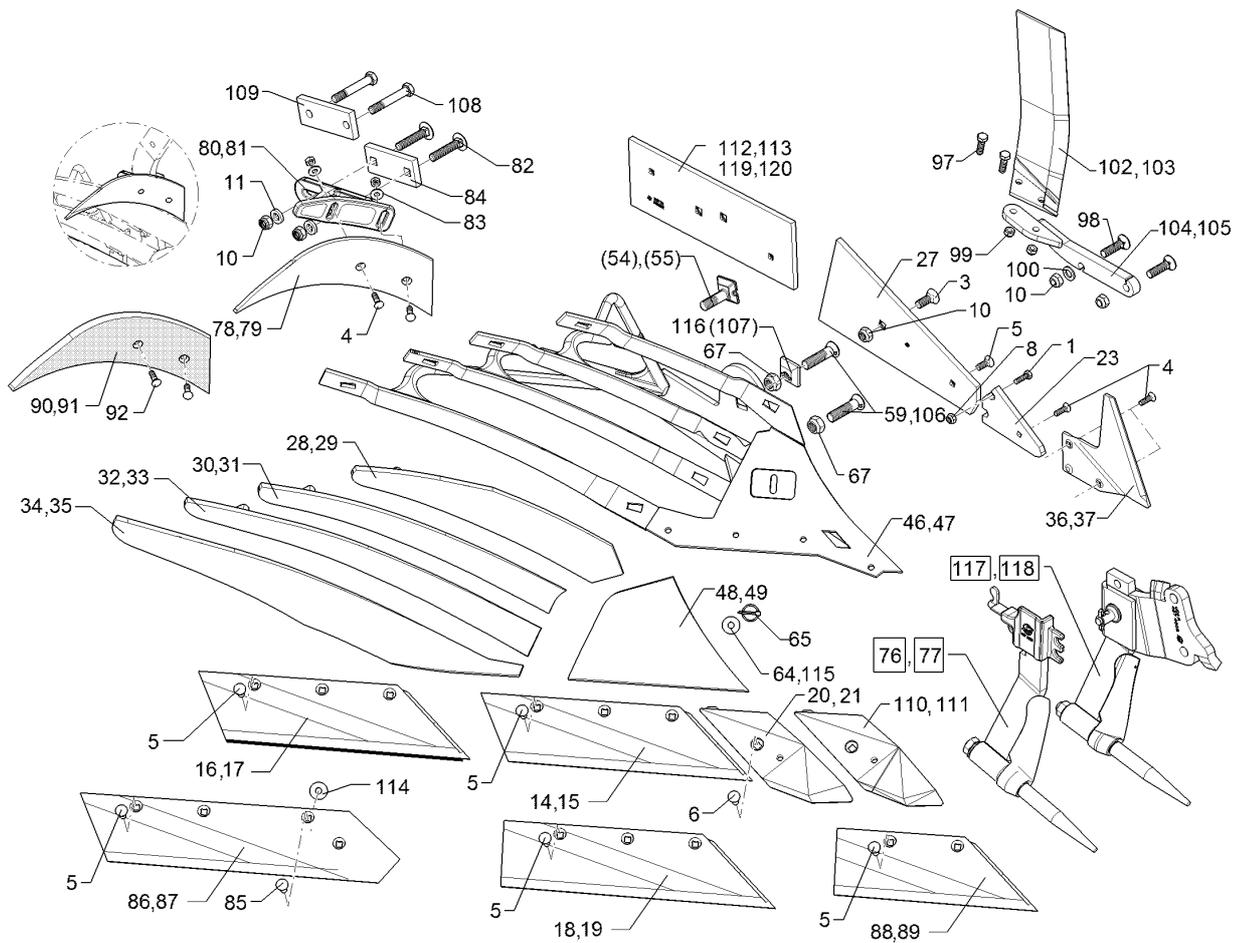

01.18

Pos.	Art.Nr.	Stck.	Artikeltext / Description		Abmessung
1	301 3212	1	Sechskantschraube	Hexagon bolt	M10x25-8.8 Zn DIN933
3	301 6142	1	Senkschraube ohne Mutter	Countersunk bolt	M16x40-10.9 4KT Zn
4	301 5767	2	Senkschraube	Countersunk bolt	M10x33-12.9-MU-10 Zn
5	301 5785	1	Senkschraube	Countersunk bolt	M12x33-12.9-MU-10 Zn
6	301 5789	1	Senkschraube	Countersunk bolt	M12x36x4-12.9-MU-10 Zn
8	303 0933	1	Sicherungsmutter	Selflocking nut	NM10-8 DIN985 Zn
10	303 0935	2	Sicherungsmutter	Selflocking nut	NM16-8 Zn DIN985
11	305 6161	2	Scheibe	Washer	17/40x6 DIN7349 Zn
14	335 2134	1	Scharblatt	Wing	SB56D RE 558x150x11
15	335 2135	1	Scharblatt	Wing	SB56D LI 558x150x11
16	335 2234	1	Scharblatt	Wing	SB56P RE 558x150x11
17	335 2235	1	Scharblatt	Wing	SB56P LI 558x150x11
18	335 2138	1	Scharblatt	Wing	SB58D RE
19	335 2139	1	Scharblatt	Wing	SB58D LI
20	336 4156	1	Scharspitze gepanzert	Point	SC2P RE
21	336 4157	1	Scharspitze gepanzert	Point	SC2P LI
23	340 1903	1	Anlagekeil	Landside wedge	AK12W 12x103x170
27	341 1525	1	Anlage	Landside	DMV1
28	34410010	1	Streichblechstreifen	Mouldboard slat	1 DMSCS40 RE

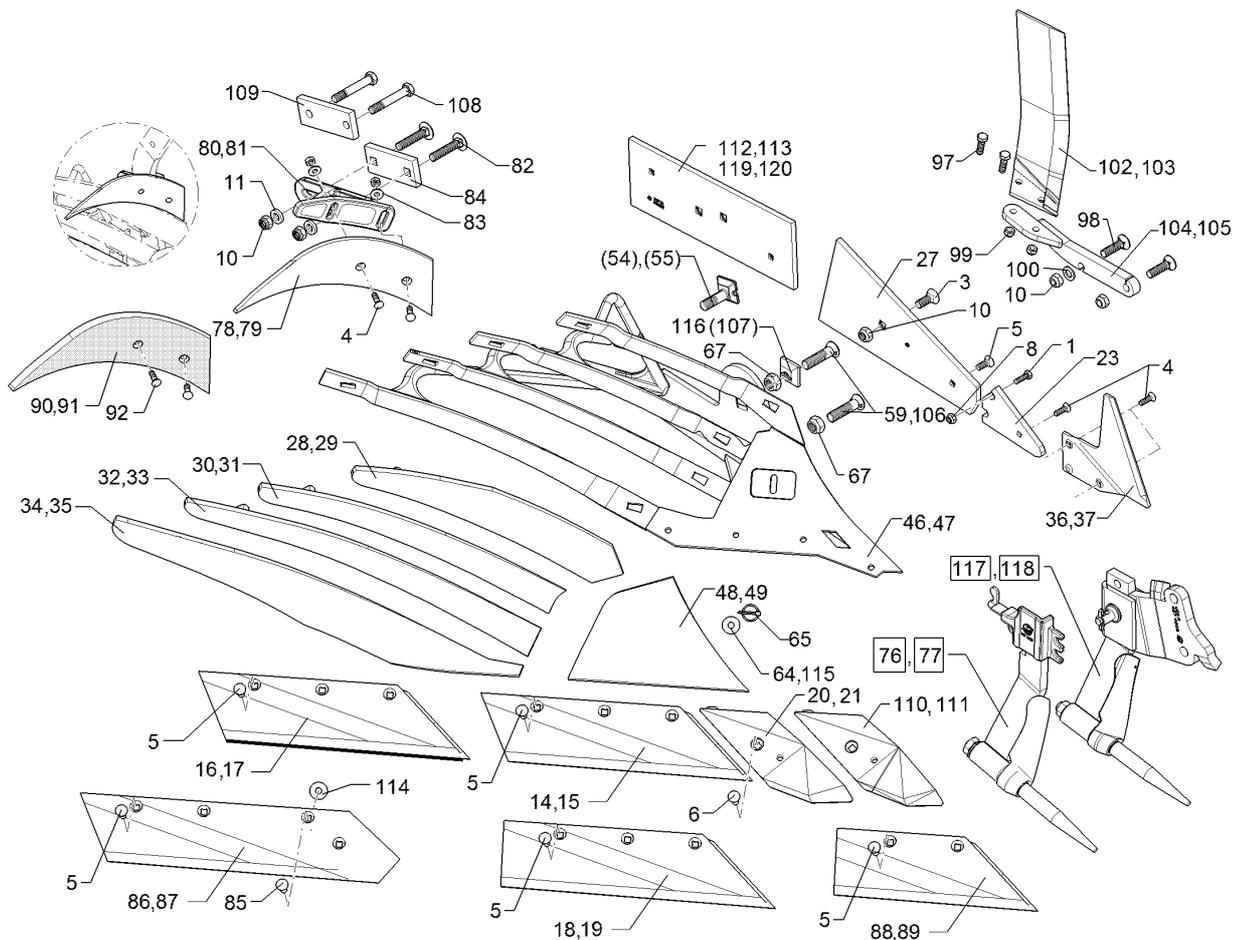

01.18

Pos.	Art.Nr.	Stck.	Artikeltext / Description		Abmessung
29	34410011	1	Streichblechstreifen	Mouldboard slat	1 DMSCS40 LI
30	34410012	1	Streichblechstreifen	Mouldboard slat	2 DMSCS40 RE
31	34410013	1	Streichblechstreifen	Mouldboard slat	2 DMSCS40 LI
32	34410014	1	Streichblechstreifen	Mouldboard slat	3 DMSCS40 RE
33	34410015	1	Streichblechstreifen	Mouldboard slat	3 DMSCS40 LI
34	34410008	1	Streichblechstreifen	Mouldboard slat	4 DMSCS RE
35	34410009	1	Streichblechstreifen	Mouldboard slat	4 DMSCS LI
36	349 2890	1	Anlagesech	Sword coultter	AS2 RE 6x238x240
37	349 2891	1	Anlagesech	Sword coultter	AS2 LI 6x238x240
46	467 1040	1	Körperrumpf	Frog	DMCS RE
47	467 1041	1	Körperrumpf	Frog	DMCS LI
48	34510002	1	Streichblechkante	Shin	DMSCK RE
49	34510003	1	Streichblechkante	Shin	DMSCK LI
54	301 5780	1	Exzentrerschraube	Eccentric screw	M20x75-12.9 R Zn
55	301 5781	1	Exzentrerschraube	Eccentric screw	M20x75-12.9 L Zn
59	301 5747	1	Senkschraube	Countersunk bolt	M20x70x8,5-12.9 Zn
64	30510060	1	Scheibe	Washer	13/35x5±0,2 Zn
65	31110015	1	Sicherheitsklappstecker	Securing pin	5x32 d1=4,5 Zn
67	303 0936	2	Sicherungsmutter	Selflocking nut	NM20-8 Zn DIN985
76	657 4612	1	Untergrunddorn	Subsoiler	DMUD-1 RE
77	657 4613	1	Untergrunddorn	Subsoiler	DMUD-1 LI
78	347 0860	1	Einlegehand	Trashboard	E4 RE
79	347 0861	1	Einlegehand	Trashboard	E4 LI

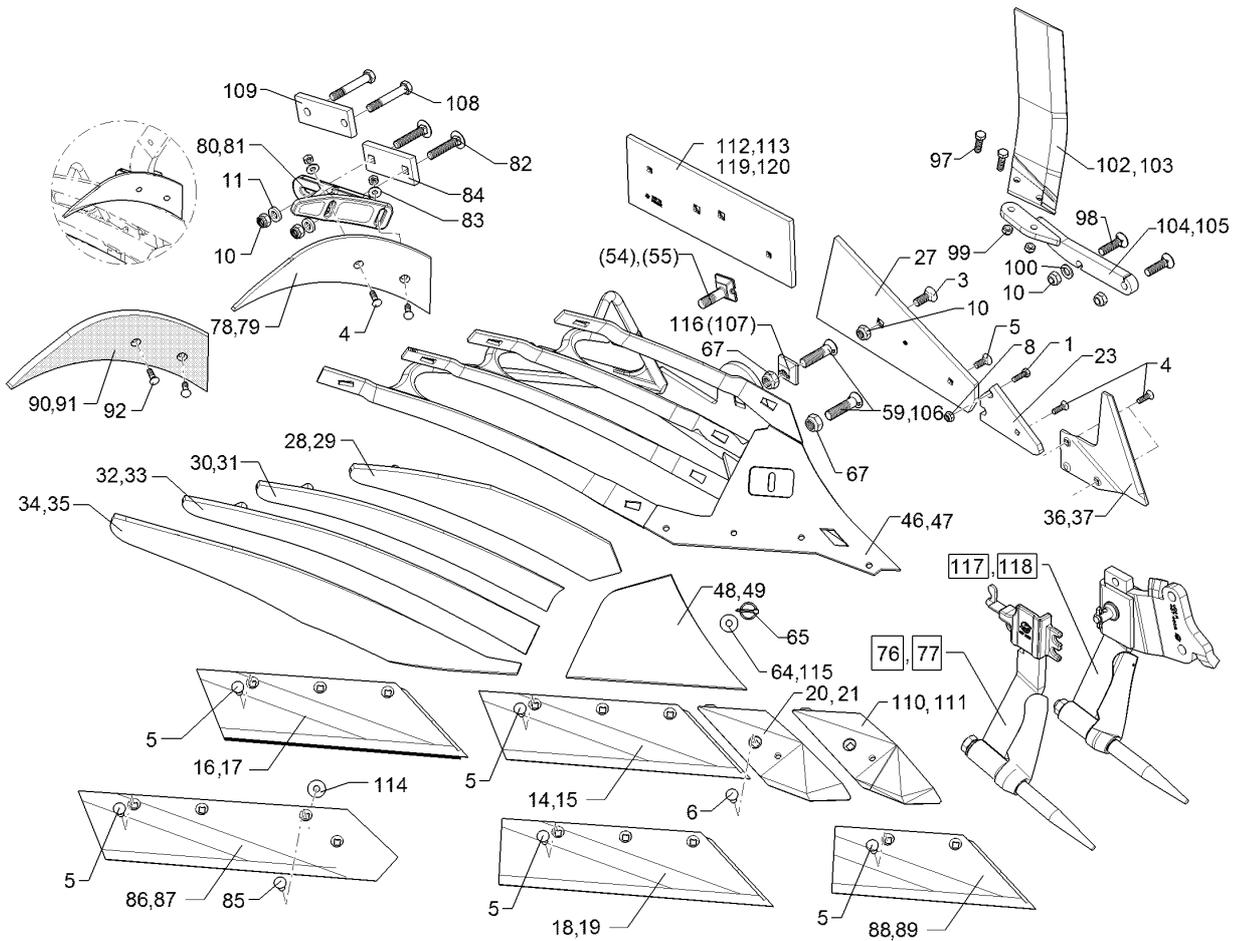

01.18

Pos.	Art.Nr.	Stck.	Artikeltext / Description		Abmessung
80	457 5218	1	Halter	Holder	DM1 E4 RE
81	457 5219	1	Halter	Holder	DM1 E4 LI
82	30110262	2	Flachrundschaube	Saucer-head screw	M16x90-10.9 DIN603 Zn
83	305 6132	2	Scheibe	Washer	D11/25x2,5 Zn
84	459 1194	1	Brücke	Clamp plate	60x15x138 1x97-4Kt17
85	301 5794	1	Senkschraube	Countersunk bolt	M12x45-12.9-MU-10 DIN608 Zn
86	333 5032	1	Steinschar	Share	S42A RE 670x150x11
87	333 5033	1	Steinschar	Share	S42A LI 670x150x11
88	335 2120	1	Scharblatt	Wing	SB43D RE 428x150x11
89	335 2121	1	Scharblatt	Wing	SB43D LI 428x150x11
90	347 0862	1	Einlegehand	Trashboard	E4KU RE
91	347 0863	1	Einlegehand	Trashboard	E4KU LI
92	301 5769	2	Senkschraube	Countersunk bolt	M10x45-12.9-MU-10 Zn
97	301 3347	2	Sechskantschraube	Hexagon bolt	M12x40-8.8 Zn DIN933
98	301 6147	2	Senkschraube spz.	Countersunk bolt	M16x60-10.9 4KT Zn
99	303 0934	2	Sicherungsmutter	Selflocking nut	NM12-8 Zn DIN985
100	305 6141	1	Scheibe	Washer	17/30x3
102	349 2860	1	Breitfurchenmesser	Knife for wide furrows	DIN/ISO-7089 BFM-RE

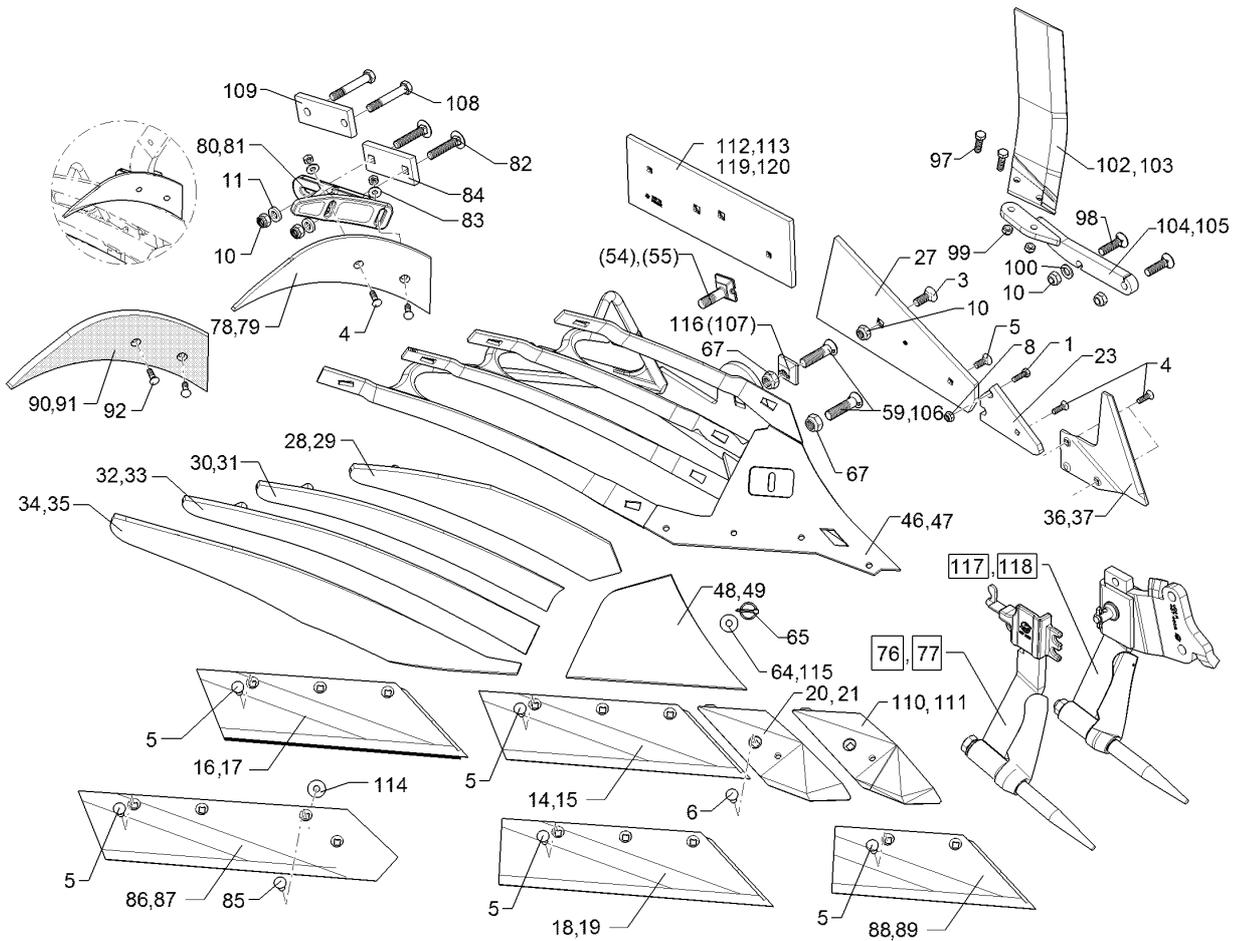

01.18

Pos.	Art.Nr.	Stck.	Artikeltext / Description		Abmessung
103	349 2861	1	Breitfurchenmesser	Knife for wide furrows	BFM-LI
104	45710008	1	Halter	Holder	BFM 3 RE DuraMaxx
105	45710009	1	Halter	Holder	BFM 3 LI DuraMaxx
106	301 5750	1	Senkschraube	Countersunk bolt	M20x80x8,5-12.9 Zn
107	31710028	1	Exzentrerscheibe	Eccentric washer	50x50x16 D20,25 Zn
109	301 3994	2	Sechskantschraube spz.	Hexagon bolt	M16x100-12.9 Zn
110	33610006	1	Scharspitze	Point	SC2PS RE
111	33610007	1	Scharspitze	Point	SC2PS LI
112	34110002	1	Anlage	Landside	DMV2 RE 160x12x460
113	34110003	1	Anlage	Landside	DMV2 LI 160x12x460
114	305 6180	1	Scheibe	Washer	15 DIN7349
115	305 8582	1	Scheibe	Washer	13/32x1,25 St-Zn
116	31710191	1	Exzentrerscheibe	Eccentric washer	50x50x16x2,5 D20,25 Zn
117	657 4608	1	Untergrunddorn	Subsoiler	UD6-80 RE
118	657 4609	1	Untergrunddorn	Subsoiler	UD6-80 LI
119	66710076	1	Anlage mit Schrauben	Landside with bolt	DMV2 RE
120	66710077	1	Anlage mit Schrauben	Landside with bolt	DMV2 LI

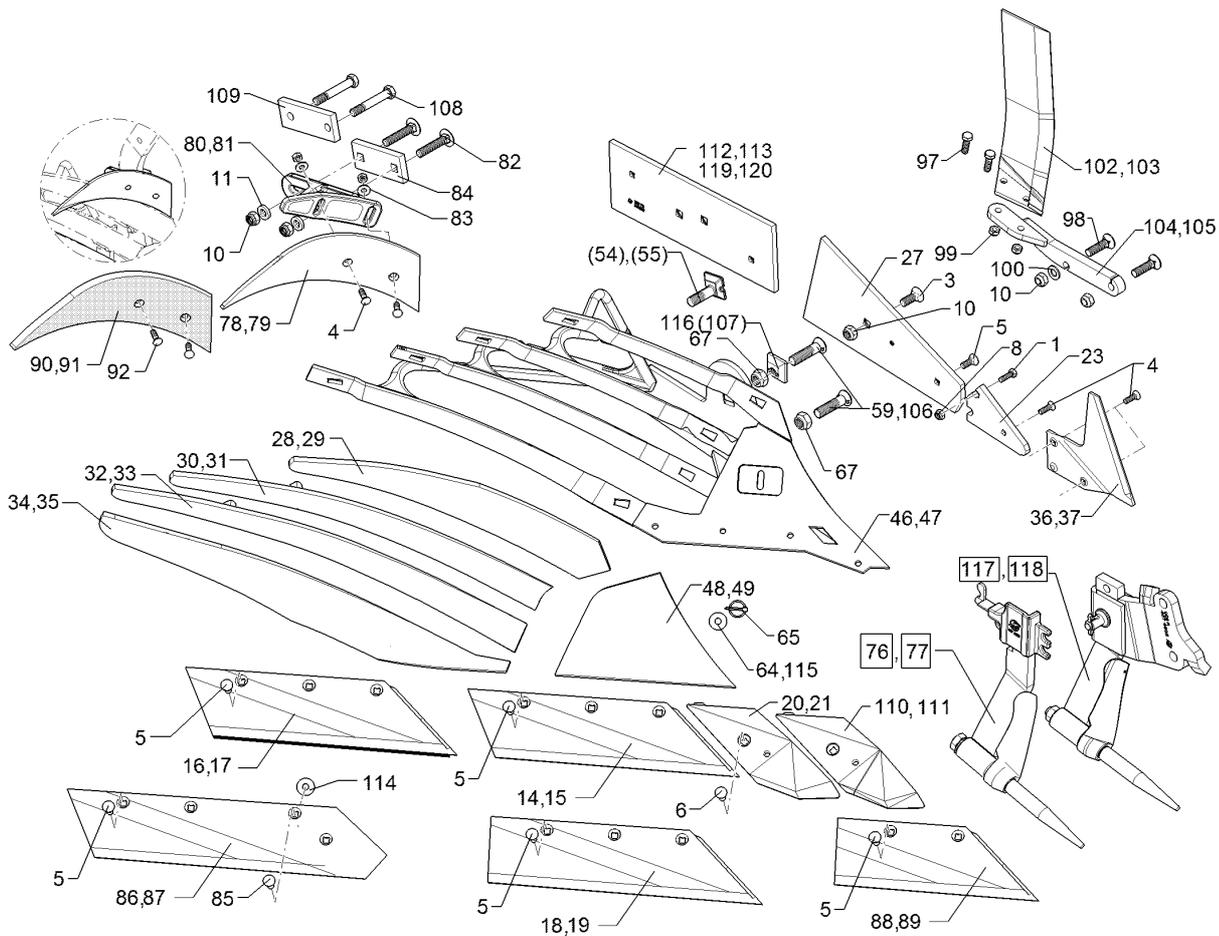

01.18

Pos.	Art.Nr.	Stck.	Artikeltext / Description		Abmessung
1	301 3212	1	Sechskantschraube	Hexagon bolt	M10x25-8.8 Zn DIN933
3	301 6142	1	Senkschraube ohne Mutter	Countersunk bolt	M16x40-10.9 4KT Zn
4	301 5767	2	Senkschraube	Countersunk bolt	M10x33-12.9-MU-10 Zn
5	301 5785	1	Senkschraube	Countersunk bolt	M12x33-12.9-MU-10 Zn
6	301 5789	1	Senkschraube	Countersunk bolt	M12x36x4-12.9-MU-10 Zn
8	303 0933	1	Sicherungsmutter	Selflocking nut	NM10-8 DIN985 Zn
10	303 0935	2	Sicherungsmutter	Selflocking nut	NM16-8 Zn DIN985
11	305 6161	2	Scheibe	Washer	17/40x6 DIN7349 Zn
14	335 2134	1	Scharblatt	Wing	SB56D RE 558x150x11
15	335 2135	1	Scharblatt	Wing	SB56D LI 558x150x11
16	335 2234	1	Scharblatt	Wing	SB56P RE 558x150x11
17	335 2235	1	Scharblatt	Wing	SB56P LI 558x150x11
18	335 2138	1	Scharblatt	Wing	SB58D RE
19	335 2139	1	Scharblatt	Wing	SB58D LI
20	336 4156	1	Scharspitze gepanzert	Point	SC2P RE
21	336 4157	1	Scharspitze gepanzert	Point	SC2P LI
23	340 1903	1	Anlagekeil	Landside wedge	AK12W 12x103x170
27	341 1525	1	Anlage	Landside	DMV1
28	34410002	1	Streichblechstreifen	Mouldboard slat	1 DMSCS50 RE

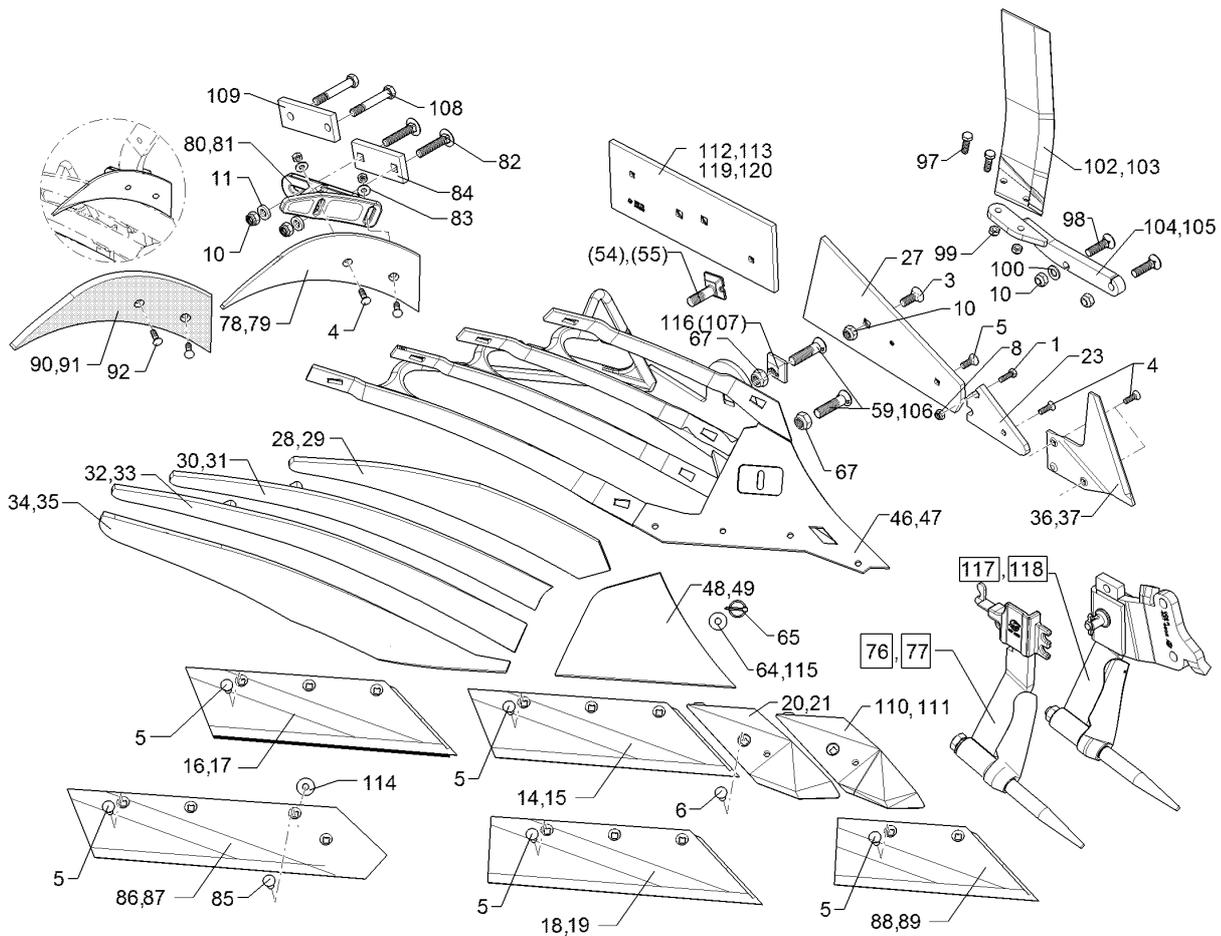

01.18

Pos.	Art.Nr.	Stck.	Artikeltext / Description		Abmessung
29	34410003	1	Streichblechstreifen	Mouldboard slat	1 DMSCS50 LI
30	34410004	1	Streichblechstreifen	Mouldboard slat	2 DMSCS50 RE
31	34410005	1	Streichblechstreifen	Mouldboard slat	2 DMSCS50 LI
32	34410007	1	Streichblechstreifen	Mouldboard slat	3 DMSCS50 LI
33	34410006	1	Streichblechstreifen	Mouldboard slat	3 DMSCS50 RE
34	34410008	1	Streichblechstreifen	Mouldboard slat	4 DMSCS RE
35	34410009	1	Streichblechstreifen	Mouldboard slat	4 DMSCS LI
36	349 2890	1	Anlagesech	Sword coulter	AS2 RE 6x238x240
37	349 2891	1	Anlagesech	Sword coulter	AS2 LI 6x238x240
46	467 1040	1	Körperrumpf	Frog	DMCS RE
47	467 1041	1	Körperrumpf	Frog	DMCS LI
48	34510002	1	Streichblechkante	Shin	DMSCK RE
49	34510003	1	Streichblechkante	Shin	DMSCK LI
54	301 5780	1	Exzentrerschraube	Eccentric screw	M20x75-12.9 R Zn
55	301 5781	1	Exzentrerschraube	Eccentric screw	M20x75-12.9 L Zn
59	301 5747	1	Senkschraube	Countersunk bolt	M20x70x8,5-12.9 Zn
64	30510060	1	Scheibe	Washer	13/35x5±0,2 Zn
65	31110015	1	Sicherheitsklappstecker	Securing pin	5x32 d1=4,5 Zn
67	303 0936	2	Sicherungsmutter	Selflocking nut	NM20-8 Zn DIN985
76	657 4612	1	Untergrunddorn	Subsoiler	DMUD-1 RE
77	657 4613	1	Untergrunddorn	Subsoiler	DMUD-1 LI
78	347 0860	1	Einlegehand	Trashboard	E4 RE
79	347 0861	1	Einlegehand	Trashboard	E4 LI

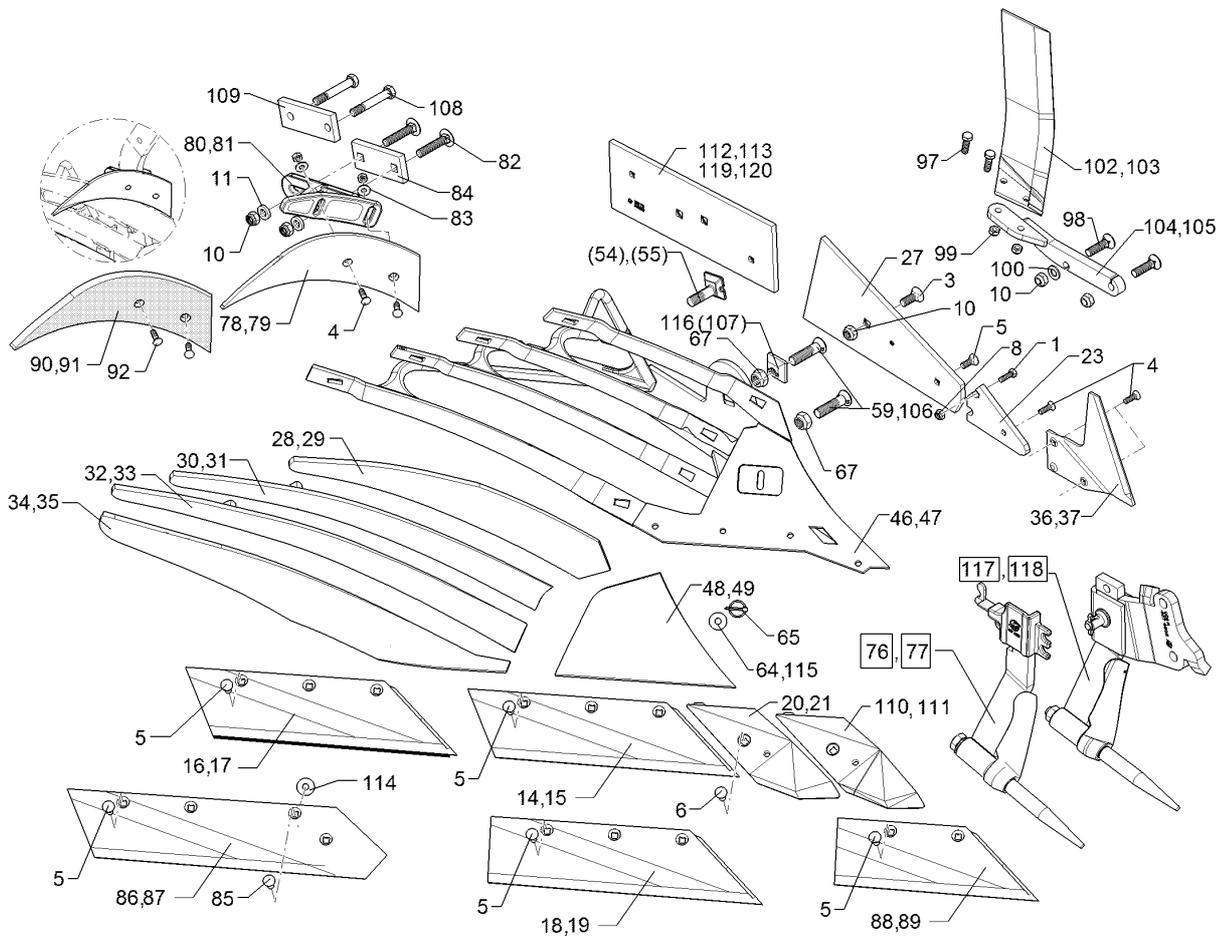

01.18

Pos.	Art.Nr.	Stck.	Artikeltext / Description		Abmessung
80	457 5218	1	Halter	Holder	DM1 E4 RE
81	457 5219	1	Halter	Holder	DM1 E4 LI
82	30110262	2	Flachrundschaube	Saucer-head screw	M16x90-10.9 DIN603 Zn
83	305 6132	2	Scheibe	Washer	D11/25x2,5 Zn
84	459 1194	1	Brücke	Clamp plate	60x15x138 1x97-4Kt17
85	301 5794	1	Senkschraube	Countersunk bolt	M12x45-12.9-MU-10 DIN608 Zn
86	333 5032	1	Steinschar	Share	S42A RE 670x150x11
87	333 5033	1	Steinschar	Share	S42A LI 670x150x11
88	335 2120	1	Scharblatt	Wing	SB43D RE 428x150x11
89	335 2121	1	Scharblatt	Wing	SB43D LI 428x150x11
90	347 0862	1	Einlegehand	Trashboard	E4KU RE
91	347 0863	1	Einlegehand	Trashboard	E4KU LI
92	301 5769	2	Senkschraube	Countersunk bolt	M10x45-12.9-MU-10 Zn
97	301 3347	2	Sechskantschraube	Hexagon bolt	M12x40-8.8 Zn DIN933
98	301 6147	2	Senkschraube spz.	Countersunk bolt	M16x60-10.9 4KT Zn
99	303 0934	2	Sicherungsmutter	Selflocking nut	NM12-8 Zn DIN985
100	305 6141	1	Scheibe	Washer	17/30x3
102	349 2860	1	Breitfurchenmesser	Knife for wide furrows	DIN/ISO-7089 BFM-RE

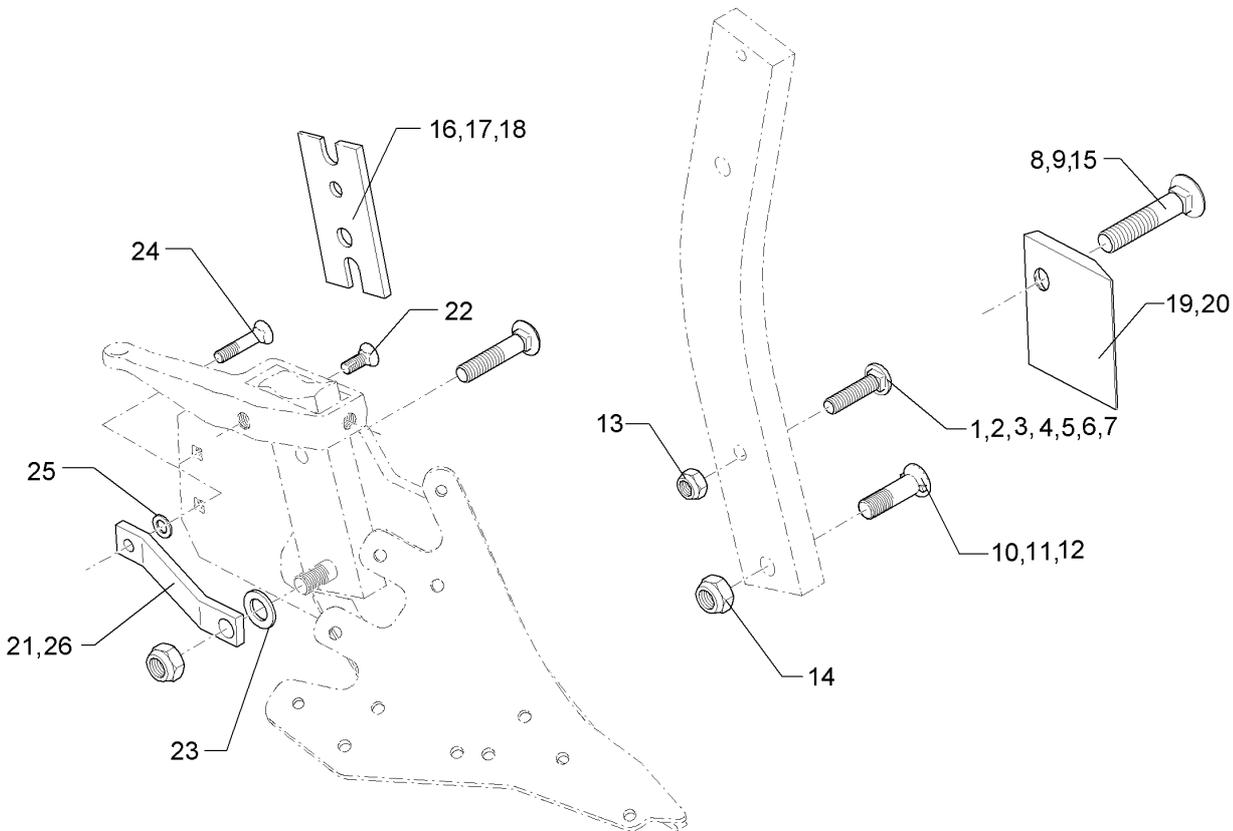

01.18

Pos.	Art.Nr.	Stck.	Artikeltext / Description		Abmessung
1	301 2211	1	Flachrundschaube	Saucer-head screw	M16x55-10.9 Zn
2	301 2227	1	Flachrundschaube	Saucer-head screw	M16x60-10.9 Zn
3	301 2242	1	Flachrundschaube	Saucer-head screw	M16x65-10.9 Zn
4	301 2261	1	Flachrundschaube	Saucer-head screw	M16x70-10.9 Zn
5	301 2279	1	Flachrundschaube	Saucer-head screw	M16x75-10.9 Zn
6	301 2292	1	Flachrundschaube	Saucer-head screw	M16x80-10.9 Zn
7	301 2312	1	Flachrundschaube	Saucer-head screw	M16x100-10.9 Zn
8	301 5740	1	Senkschraube	Countersunk bolt	M16x80-10.9 Zn
9	301 5741	1	Senkschraube	Countersunk bolt	M16x105-10.9 Zn
10	301 5747	1	Senkschraube	Countersunk bolt	M20x70x8,5-12.9 Zn
11	301 5750	1	Senkschraube	Countersunk bolt	M20x80x8,5-12.9 Zn
12	301 5753	1	Senkschraube	Countersunk bolt	M20x100x8,5-12.9 Zn
13	303 0935	1	Sicherungsmutter	Selflocking nut	NM16-8 Zn DIN985
14	303 0936	1	Sicherungsmutter	Selflocking nut	NM20-8 Zn DIN985
15	301 5739	1	Senkschraube	Countersunk bolt	M16x65-10.9 Zn
16	469 1896	1	Keil	Wedge	80x200-2 GRD
17	469 1899	1	Keil	Wedge	80x200 4GRD Zn
18	469 1900	1	Keil	Wedge	70x210-6 GRD
19	340 1480	1	Rumpfschoner	Frog-protector	SCR11 RE 130x114
20	340 1481	1	Rumpfschoner	Frog-protector	SCR11 LI 130x114
21	469 5480	1	Verstärkung	Strengthening	40x10x260+D12,25+D20,25 gekr.

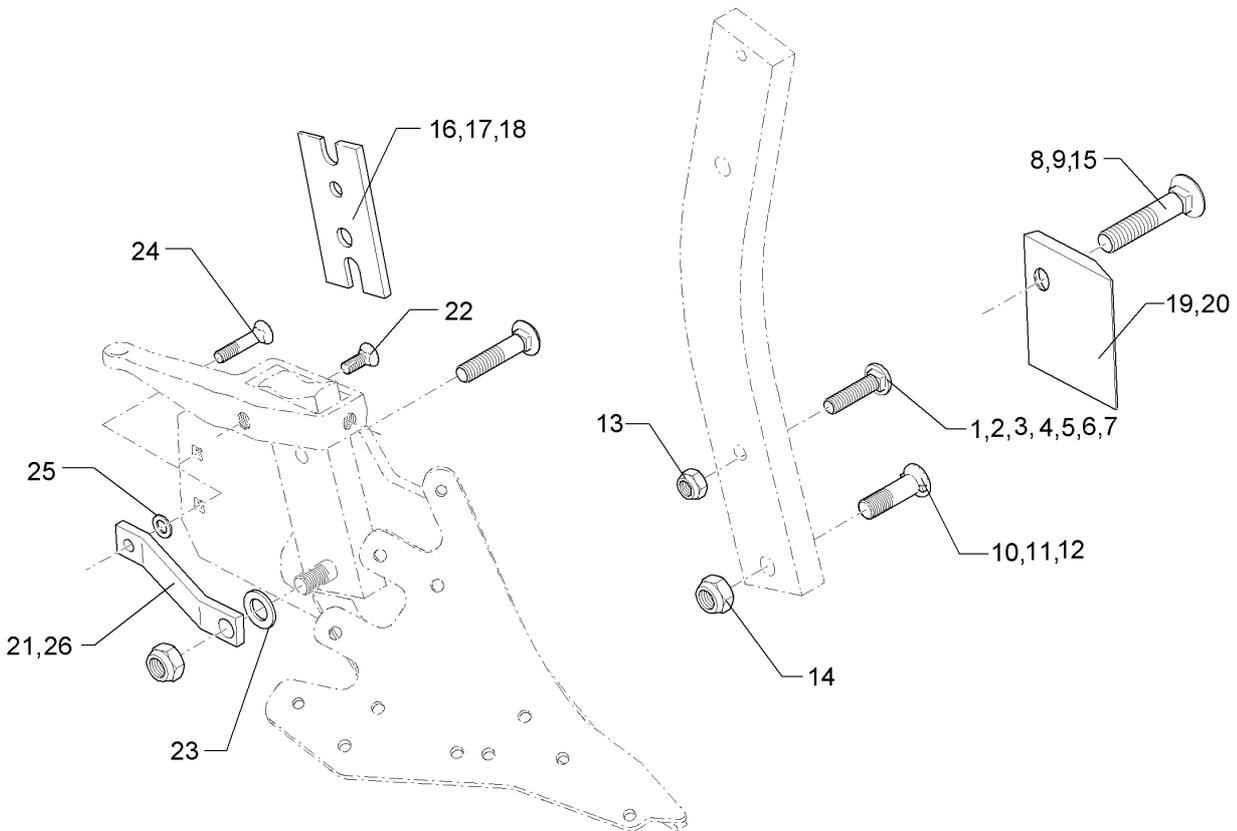

01.18

Pos.	Art.Nr.	Stck.	Artikeltext / Description		Abmessung
22	301 5785	1	Senkschraube	Countersunk bolt	M12x33-12.9-MU-10 Zn
23	305 6012	1	Scheibe	Washer	21 ISO7089 Zn
24	301 5794	1	Senkschraube	Countersunk bolt	M12x45-12.9-MU-10 DIN608 Zn
25	305 6167	1	Scheibe	Washer	13/35x5 Zn DIN 6340
26	469 5478	1	Verstärkung	Strengthening	40x10x320 TK16

Düngereinlegerhalm/Skim stalk	12
--------------------------------------	-----------

Juwel 7M	663 8750
-----------------	-----------------

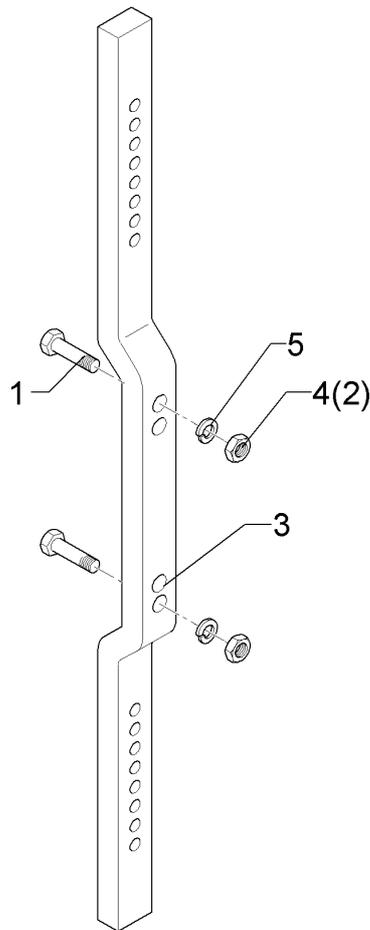

01.18

Pos.	Art.Nr.	Stck.	Artikeltext / Description		Abmessung
1	301 3870	2	Sechskantschraube spz.	Hexagon bolt	M16x65-10.9 Zn
2	303 0971	2	Sechskantmutter	Hexagon nut	M16 DIN934-10 Zn
3	463 8641	1	Düngereinlegerhalm	Skim stalk	50x30x0974-220/260
4	303 1015	2	Sechskantmutter	Hexagon nut	M16 DIN934-8 Zn
5	30510119	4	Sperrkantscheibe	Washer	16,4/32,5x2,5 Zn5

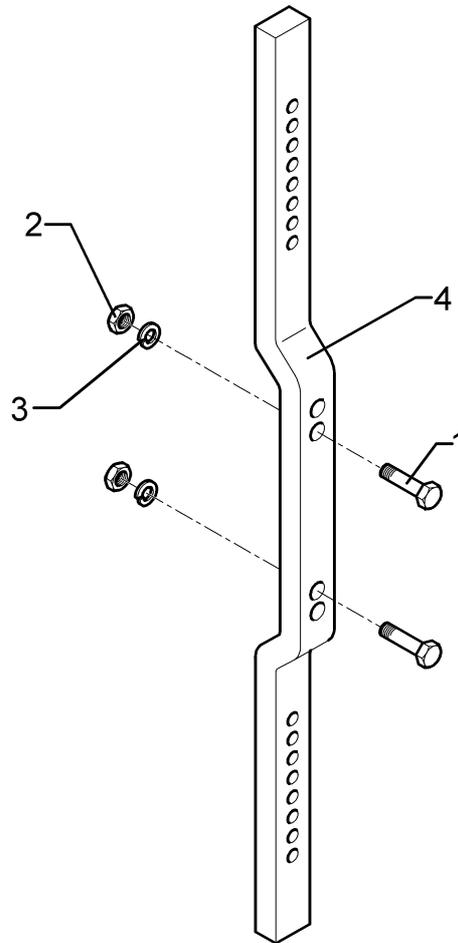

01.18

Pos.	Art.Nr.	Stck.	Artikeltext / Description		Abmessung
1	301 3870	2	Sechskantschraube spz.	Hexagon bolt	M16x65-10.9 Zn
2	303 0971	2	Sechskantmutter	Hexagon nut	M16 DIN934-10 Zn
3	30510119	4	Sperrkantscheibe	Washer	16,4/32,5x2,5 Zn5
4	463 8642	1	Düngereinlegerhalm	Skim stalk	50x30x1124-260

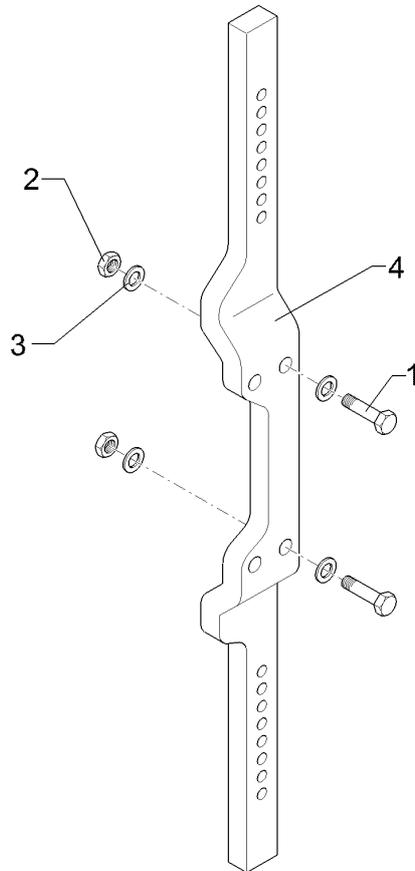

01.18

Pos.	Art.Nr.	Stck.	Artikeltext / Description		Abmessung
1	301 3870	4	Sechskantschraube spz.	Hexagon bolt	M16x65-10.9 Zn
2	303 0971	4	Sechskantmutter	Hexagon nut	M16 DIN934-10 Zn
3	30510119	8	Sperrkantscheibe	Washer	16,4/32,5x2,5 Zn5
4	463 8639	1	Düngereinlegerhalm	Skim stalk	50/95x30x1174-260-V 4xD16,25

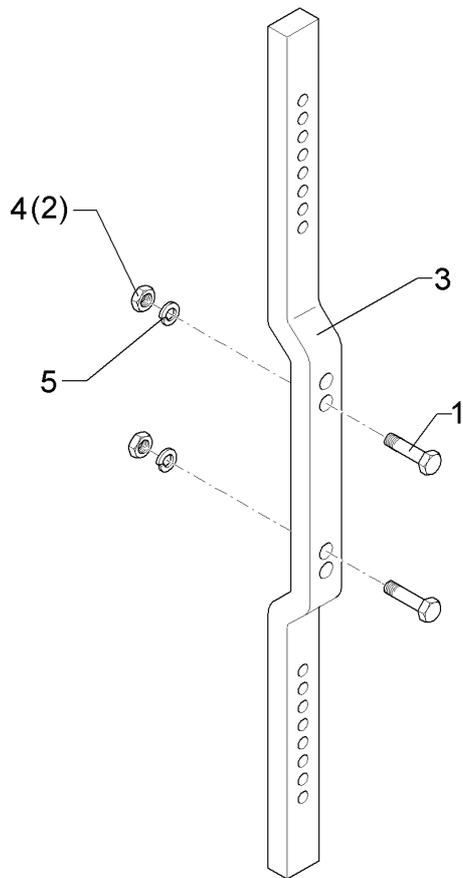

01.18

Pos.	Art.Nr.	Stck.	Artikeltext / Description		Abmessung
1	301 3870	2	Sechskantschraube spz.	Hexagon bolt	M16x65-10.9 Zn
3	463 8651	1	Düngereinlegerhalm	Skim stalk	50x30x1327-260/220 H900
4	303 0971	2	Sechskantmutter	Hexagon nut	M16 DIN934-10 Zn
5	30510119	4	Sperrkantscheibe	Washer	16,4/32,5x2,5 Zn5

Düngereinlegerhalm/Skim stalk	12
--------------------------------------	-----------

Juwel 7M	663 8770
-----------------	-----------------

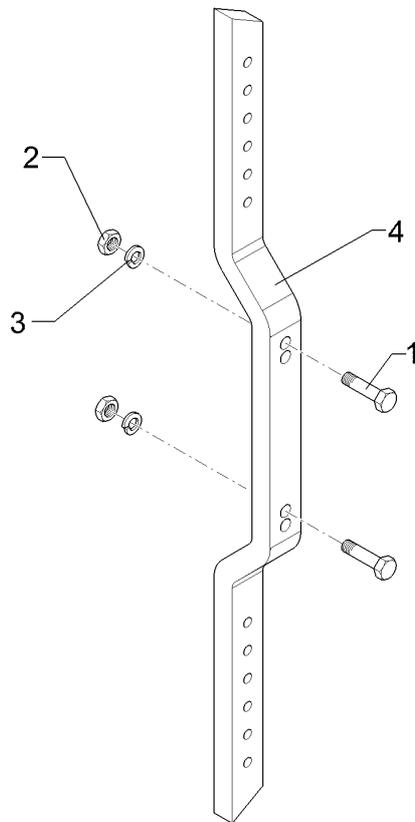

01.18

Pos.	Art.Nr.	Stck.	Artikeltext / Description		Abmessung
1	301 3779	2	Sechskantschraube spz.	Hexagon bolt	M16x60-10.9 Zn
2	303 1015	2	Sechskantmutter	Hexagon nut	M16 DIN934-8 Zn
3	305 6141	2	Scheibe	Washer	17/30x3 DIN/ISO-7089
4	463 8659	1	Düngereinlegerhalm	Skim stalk	50x30x1149-220/260

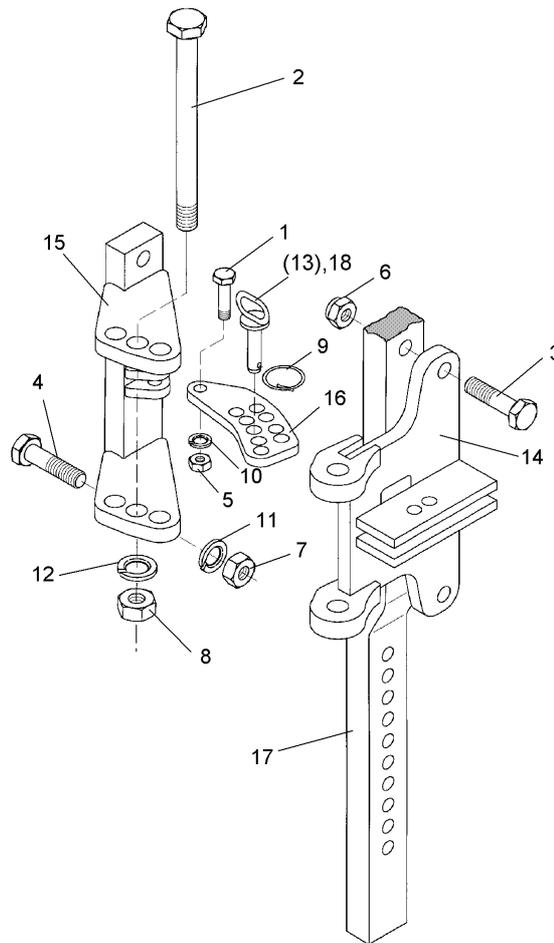

01.18

Pos.	Art.Nr.	Stck.	Artikeltext / Description		Abmessung
1	301 3351	1	Sechskantschraube spz.	Hexagon bolt	M12x50-8.8 Zn
2	301 4540	1	Sechskantschraube spz.	Hexagon bolt	M20x1,5x200-10.9 Zn
3	301 5363	2	Sechskantschraube spz.	Hexagon bolt	M16x70-12.9 Zn
4	301 3779	2	Sechskantschraube spz.	Hexagon bolt	M16x60-10.9 Zn
5	303 0934	1	Sicherungsmutter	Selflocking nut	NM12-8 Zn DIN985
7	303 0971	4	Sechskantmutter	Hexagon nut	M16 DIN934-10 Zn
8	303 0977	1	Sechskantmutter	Hexagon nut	M20x1,5 DIN934-10 Zn
9	311 9565	1	Klappstift	Securing pin	4,5
10	305 8580	2	Scheibe	Washer	13/24x2,5 St-Zn DIN125
11	30510119	8	Sperrkantscheibe	Washer	16,4/32,5x2,5 Zn5
12	305 6012	2	Scheibe	Washer	21 ISO7089 Zn
14	457 7230	1	Schwenkkonsole	Swivel bracket	DE 220 D16,5
15	457 7231	1	Konsole	Bracket	DE 220 D16,5 E6+7
16	457 7204	1	Lasche	Lashing	50x10x142 9xD14,2+1xD12,1
17	463 8641	1	Düngereinlegerhalm	Skim stalk	50x30x0974-220/260
18	313 8158	1	Bolzen mit Griff	Pin with grip	D14x61/103 Zn

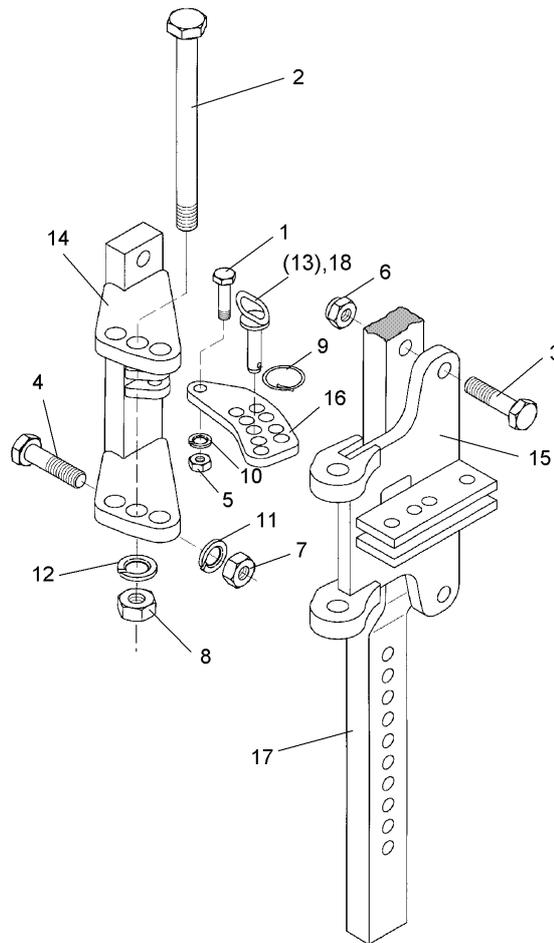

01.18

Pos.	Art.Nr.	Stck.	Artikeltext / Description		Abmessung
1	301 3351	1	Sechskantschraube spz.	Hexagon bolt	M12x50-8.8 Zn
2	301 4540	1	Sechskantschraube spz.	Hexagon bolt	M20x1,5x200-10.9 Zn
3	301 5363	2	Sechskantschraube spz.	Hexagon bolt	M16x70-12.9 Zn
4	301 3779	2	Sechskantschraube spz.	Hexagon bolt	M16x60-10.9 Zn
5	303 0934	1	Sicherungsmutter	Selflocking nut	NM12-8 Zn DIN985
7	303 0971	4	Sechskantmutter	Hexagon nut	M16 DIN934-10 Zn
8	303 0977	1	Sechskantmutter	Hexagon nut	M20x1,5 DIN934-10 Zn
9	311 9565	1	Klappstift	Securing pin	4,5
10	305 8580	2	Scheibe	Washer	13/24x2,5 St-Zn DIN125
11	30510119	8	Sperrkantscheibe	Washer	16,4/32,5x2,5 Zn5
12	305 6012	2	Scheibe	Washer	21 ISO7089 Zn
14	457 7231	1	Konsole	Bracket	DE 220 D16,5 E6+7
15	457 7230	1	Schwenkkonsole	Swivel bracket	DE 220 D16,5
16	457 7204	1	Lasche	Lashing	50x10x142 9xD14,2+1xD12,1
17	463 8642	1	Düngereinlegerhalm	Skim stalk	50x30x1124-260
18	313 8158	1	Bolzen mit Griff	Pin with grip	D14x61/103 Zn

Düngereinlegerhalm/Skim stalk	12
--------------------------------------	-----------

Juwel 7M	66310003
-----------------	-----------------

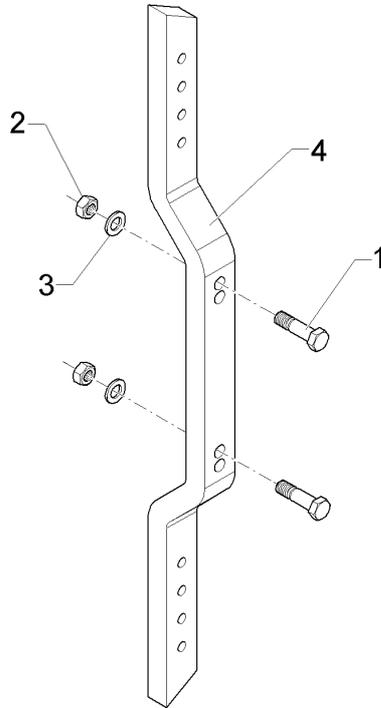

01.18

Pos.	Art.Nr.	Stck.	Artikeltext / Description		Abmessung
1	301 3779	2	Sechskantschraube spz.	Hexagon bolt	M16x60-10.9 Zn
2	303 1015	2	Sechskantmutter	Hexagon nut	M16 DIN934-8 Zn
3	305 6141	2	Scheibe	Washer	17/30x3 DIN/ISO-7089
4	463 8671	1	Düngereinlegerhalm	Skim stalk	50x30x989/62-220/260

Düngereinlegerhalm/Skim stalk	12
--------------------------------------	-----------

Juwel 7M	66310004
-----------------	-----------------

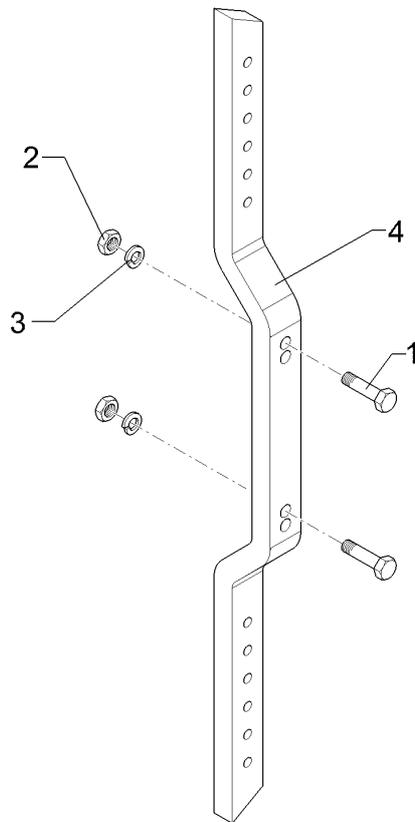

01.18

Pos.	Art.Nr.	Stck.	Artikeltext / Description		Abmessung
1	301 3779	2	Sechskantschraube spz.	Hexagon bolt	M16x60-10.9 Zn
2	303 1015	2	Sechskantmutter	Hexagon nut	M16 DIN934-8 Zn
3	305 6141	2	Scheibe	Washer	17/30x3 DIN/ISO-7089
4	463 8669	1	Düngereinlegerhalm	Skim stalk	50x30x1324-260/220 H900

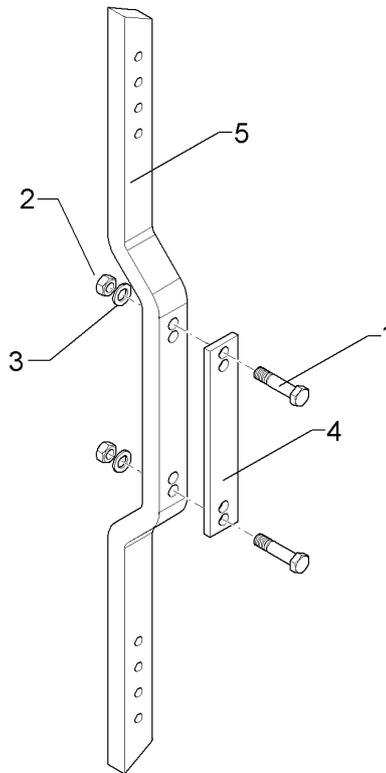

01.18

Pos.	Art.Nr.	Stck.	Artikeltext / Description		Abmessung
1	301 5363	2	Sechskantschraube spz.	Hexagon bolt	M16x70-12.9 Zn
2	303 1015	2	Sechskantmutter	Hexagon nut	M16 DIN934-8 Zn
3	305 6141	2	Scheibe	Washer	17/30x3 DIN/ISO-7089
4	459 1182	1	Brücke	Clamp plate	50x10x290 220/260-4xD16,5
5	463 8671	1	Düngereinlegerhalm	Skim stalk	50x30x989/62-220/260

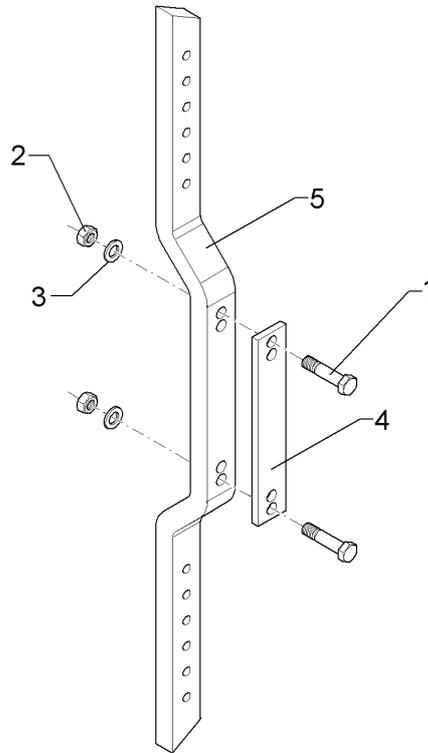

01.18

Pos.	Art.Nr.	Stck.	Artikeltext / Description		Abmessung
1	301 5363	2	Sechskantschraube spz.	Hexagon bolt	M16x70-12.9 Zn
2	303 1015	2	Sechskantmutter	Hexagon nut	M16 DIN934-8 Zn
3	305 6141	2	Scheibe	Washer	17/30x3 DIN/ISO-7089
4	459 1182	1	Brücke	Clamp plate	50x10x290 220/260-4xD16,5
5	463 8659	1	Düngereinlegerhalm	Skim stalk	50x30x1149-220/260

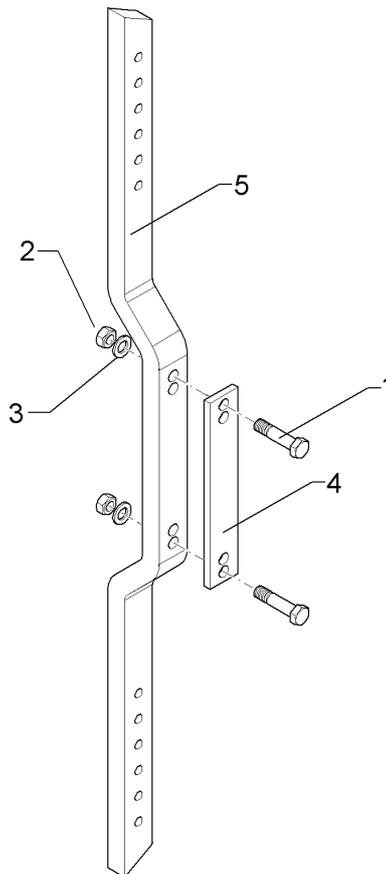

01.18

Pos.	Art.Nr.	Stck.	Artikeltext / Description		Abmessung
1	301 5363	2	Sechskantschraube spz.	Hexagon bolt	M16x70-12.9 Zn
2	303 1015	2	Sechskantmutter	Hexagon nut	M16 DIN934-8 Zn
3	305 6141	2	Scheibe	Washer	17/30x3 DIN/ISO-7089
4	459 1182	1	Brücke	Clamp plate	50x10x290 220/260-4xD16,5
5	463 8669	1	Düngereinlegerhalm	Skim stalk	50x30x1324-260/220 H900

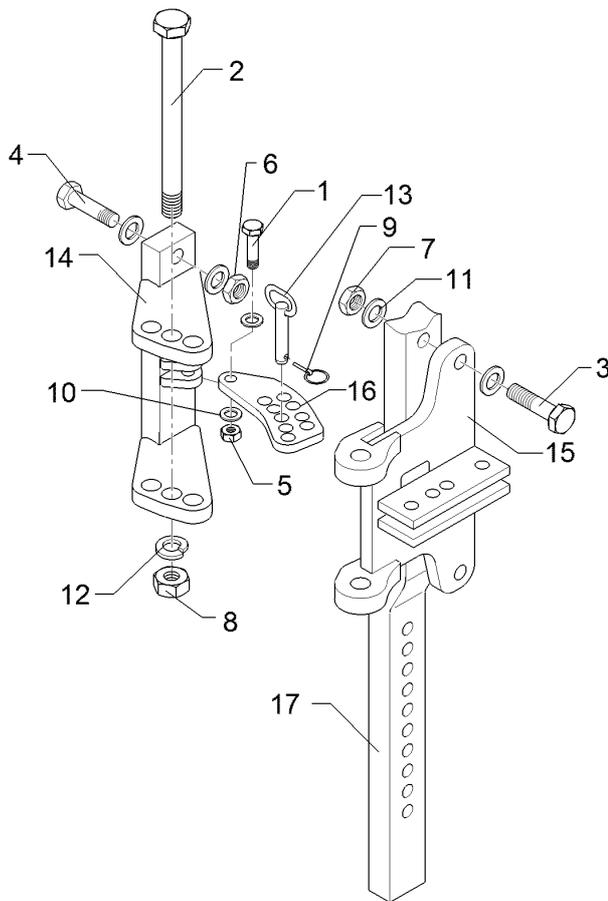

01.18

Pos.	Art.Nr.	Stck.	Artikeltext / Description		Abmessung
1	301 3351	1	Sechskantschraube spz.	Hexagon bolt	M12x50-8.8 Zn
2	301 4540	1	Sechskantschraube spz.	Hexagon bolt	M20x1,5x200-10.9 Zn
3	301 3779	2	Sechskantschraube spz.	Hexagon bolt	M16x60-10.9 Zn
4	301 5363	2	Sechskantschraube spz.	Hexagon bolt	M16x70-12.9 Zn
5	303 0934	1	Sicherungsmutter	Selflocking nut	NM12-8 Zn DIN985
6	303 0971	4	Sechskantmutter	Hexagon nut	M16 DIN934-10 Zn
8	303 0977	1	Sechskantmutter	Hexagon nut	M20x1,5 DIN934-10 Zn
9	311 9565	1	Klappstift	Securing pin	4,5
10	305 8580	2	Scheibe	Washer	13/24x2,5 St-Zn DIN125
11	30510119	8	Sperrkantscheibe	Washer	16,4/32,5x2,5 Zn5
12	305 6012	2	Scheibe	Washer	21 ISO7089 Zn
13	313 8158	1	Bolzen mit Griff	Pin with grip	D14x61/103 Zn
14	457 7231	1	Konsole	Bracket	DE 220 D16,5 E6+7
15	457 7230	1	Schwenkkonsole	Swivel bracket	DE 220 D16,5
16	457 7204	1	Lasche	Lashing	50x10x142 9xD14,2+1xD12,1
17	463 8651	1	Düngereinlegerhalm	Skim stalk	50x30x1327-260/220 H900

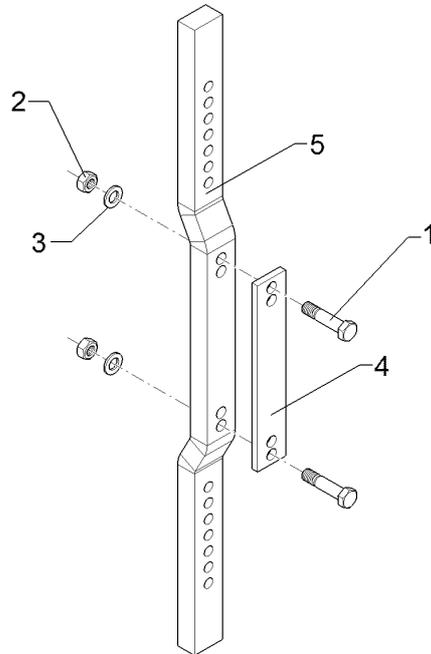

01.18

Pos.	Art.Nr.	Stck.	Artikeltext / Description		Abmessung
1	301 5361	2	Sechskantschraube spz.	Hexagon bolt	M16x75-12.9 Zn
2	303 0971	2	Sechskantmutter	Hexagon nut	M16 DIN934-10 Zn
3	30510119	4	Sperrkantscheibe	Washer	16,4/32,5x2,5 Zn5
4	459 1182	1	Brücke	Clamp plate	50x10x290
5	463 8641	1	Düngereinlegerhalm	Skim stalk	220/260-4xD16,5 50x30x0974-220/260

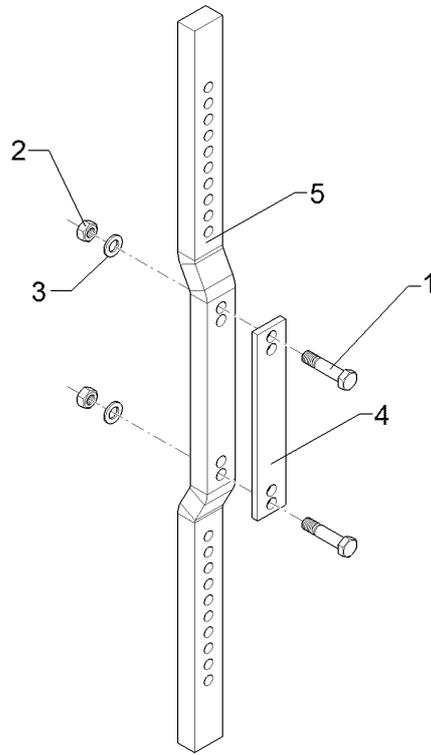

01.18

Pos.	Art.Nr.	Stck.	Artikeltext / Description		Abmessung
1	301 5361	2	Sechskantschraube spz.	Hexagon bolt	M16x75-12.9 Zn
2	303 0971	2	Sechskantmutter	Hexagon nut	M16 DIN934-10 Zn
3	30510119	4	Sperrkantscheibe	Washer	16,4/32,5x2,5 Zn5
4	459 1182	1	Brücke	Clamp plate	50x10x290
5	463 8642	1	Düngereinlegerhalm	Skim stalk	220/260-4xD16,5 50x30x1124-260

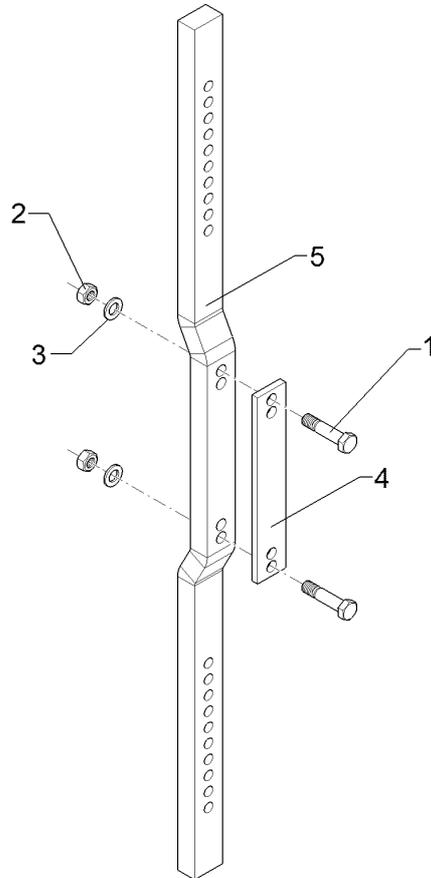

01.18

Pos.	Art.Nr.	Stck.	Artikeltext / Description		Abmessung
1	301 5361	2	Sechskantschraube spz.	Hexagon bolt	M16x75-12.9 Zn
2	303 0971	2	Sechskantmutter	Hexagon nut	M16 DIN934-10 Zn
3	30510119	4	Sperrkantscheibe	Washer	16,4/32,5x2,5 Zn5
4	459 1182	1	Brücke	Clamp plate	50x10x290
5	463 8651	1	Düngereinlegerhalm	Skim stalk	220/260-4xD16,5 50x30x1327-260/220 H900

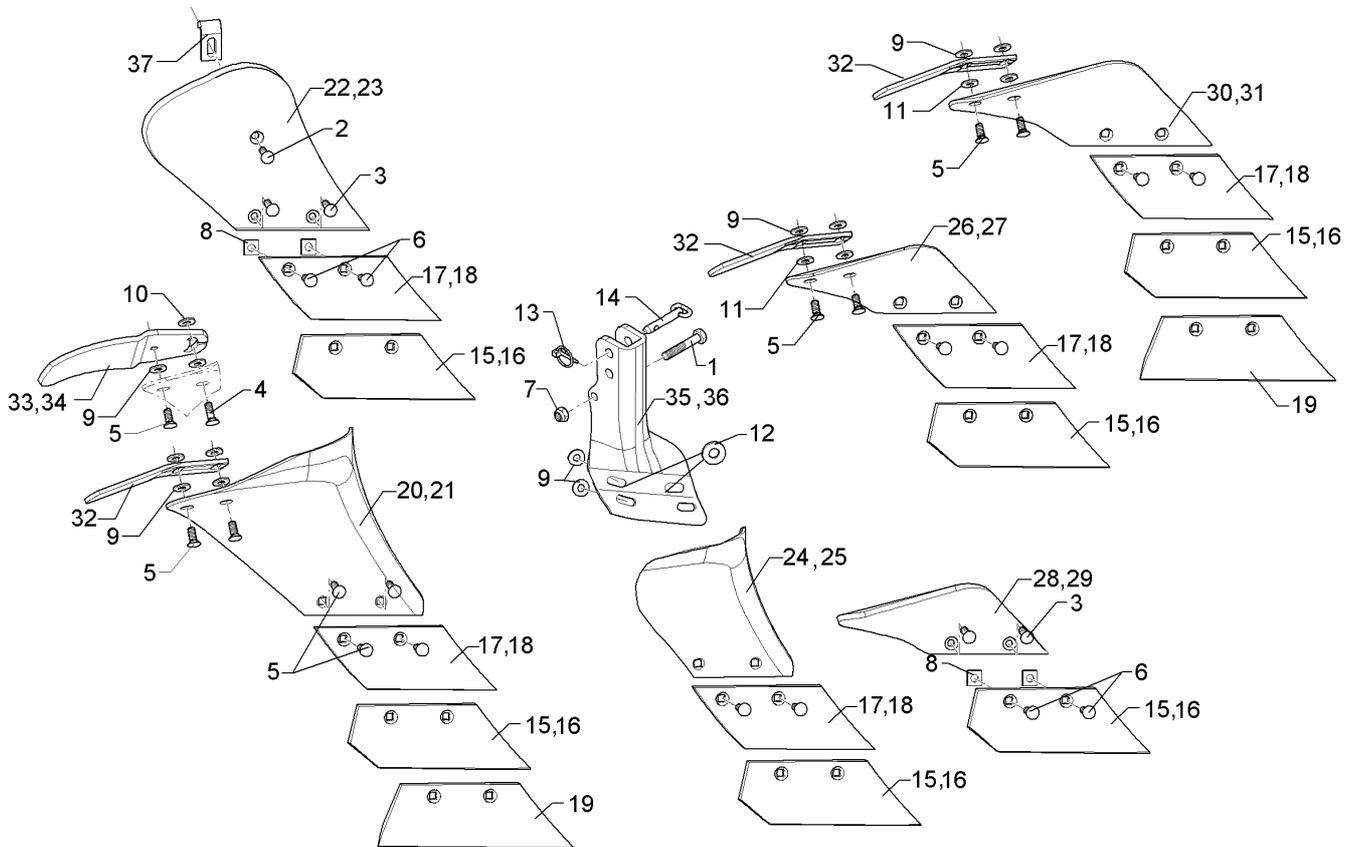

01.18

Pos.	Art.Nr.	Stck.	Artikeltext / Description		Abmessung
1	301 3406	1	Sechskantschraube	Hexagon bolt	M12x70-8.8 Zn DIN931-A
2	301 5721	1	Senkschraube	Countersunk bolt	M10x33x4-12.9 Zn
3	301 5722	2	Senkschraube	Countersunk bolt	M10x45x4-12.9 Zn
4	301 5767	2	Senkschraube	Countersunk bolt	M10x33-12.9-MU-10 Zn
5	301 5771	2	Senkschraube	Countersunk bolt	M10x25-8.8-MU Zn DIN608
6	301 5773	2	Senkschraube	Countersunk bolt	M10x35-8.8-MU Zn DIN608
7	303 0934	1	Sicherungsmutter	Selflocking nut	NM12-8 Zn DIN985
8	305 5903	4	Scheibe vierkant	Washer	13,5 DIN436 Zn
9	305 6132	5	Scheibe	Washer	D11/25x2,5 Zn
10	305 6134	1	Scheibe	Washer	D25/11x5 Zn
11	305 8580	2	Scheibe	Washer	13/24x2,5 St-Zn DIN125
12	305 7703	2	Scheibe Graupappe	Washer	D35/16x5
13	311 9565	1	Klappstift	Securing pin	4,5
14	313 8158	1	Bolzen mit Griff	Pin with grip	D14x61/103 Zn
15	336 3710	1	Schar	Share	S270 RE
16	336 3711	1	Schar	Share	S270 LI
17	336 3720	1	Schar	Share	S190 RE
18	336 3721	1	Schar	Share	S190 LI
19	336 3724	1	Schar	Share	S360
20	347 0600	1	Streichblech	Mouldboard	M2 RE

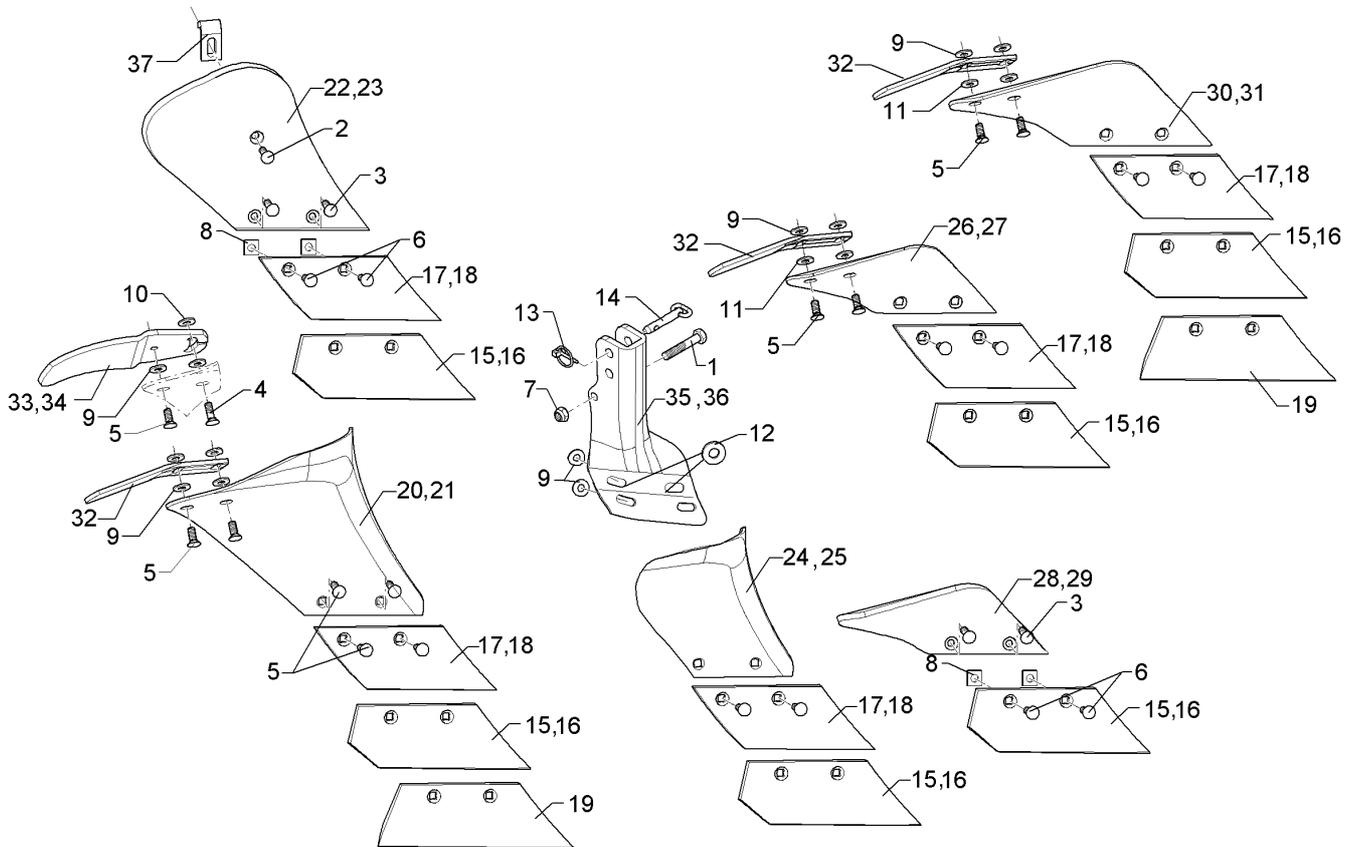

01.18

Pos.	Art.Nr.	Stck.	Artikeltext / Description		Abmessung
21	347 0601	1	Streichblech	Mouldboard	M2 LI
22	347 0604	1	Streichblech	Mouldboard	M2KU RE
23	347 0605	1	Streichblech	Mouldboard	M2KU LI
24	347 0620	1	Streichblech	Mouldboard	M3 RE
25	347 0621	1	Streichblech	Mouldboard	M3 LI
26	347 0650	1	Streichblech	Mouldboard	D1 RE
27	347 0651	1	Streichblech	Mouldboard	D1 LI
28	347 0652	1	Streichblech	Mouldboard	D1KU RE
29	347 0653	1	Streichblech	Mouldboard	D1KU LI
30	347 0654	1	Streichblech	Mouldboard	D0 RE
31	347 0655	1	Streichblech	Mouldboard	D0 LI
32	347 3650	1	Streichschiene	Tail piece	STD1 60x6x230
33	347 3652	1	Streichschiene	Tail piece	STD2 RE
34	347 3653	1	Streichschiene	Tail piece	STD2 LI
35	457 0840	1	Körperrumpf	Frog	50x30-10 RE
36	457 0841	1	Körperrumpf	Frog	50x30-10 LI
37	469 3402	1	Winkel	Angle	30x8x89
38	657 1494	1	Düngereinleger	Skimmer	F50x30-10 M2KU/S190 RE
39	657 1495	1	Düngereinleger	Skimmer	F50x30-10 M2KU/S190 LI
40	657 1496	1	Düngereinleger	Skimmer	F50x30-10 M2KU/S270 RE
41	657 1497	1	Düngereinleger	Skimmer	F50x30-10 M2KU/S270 LI

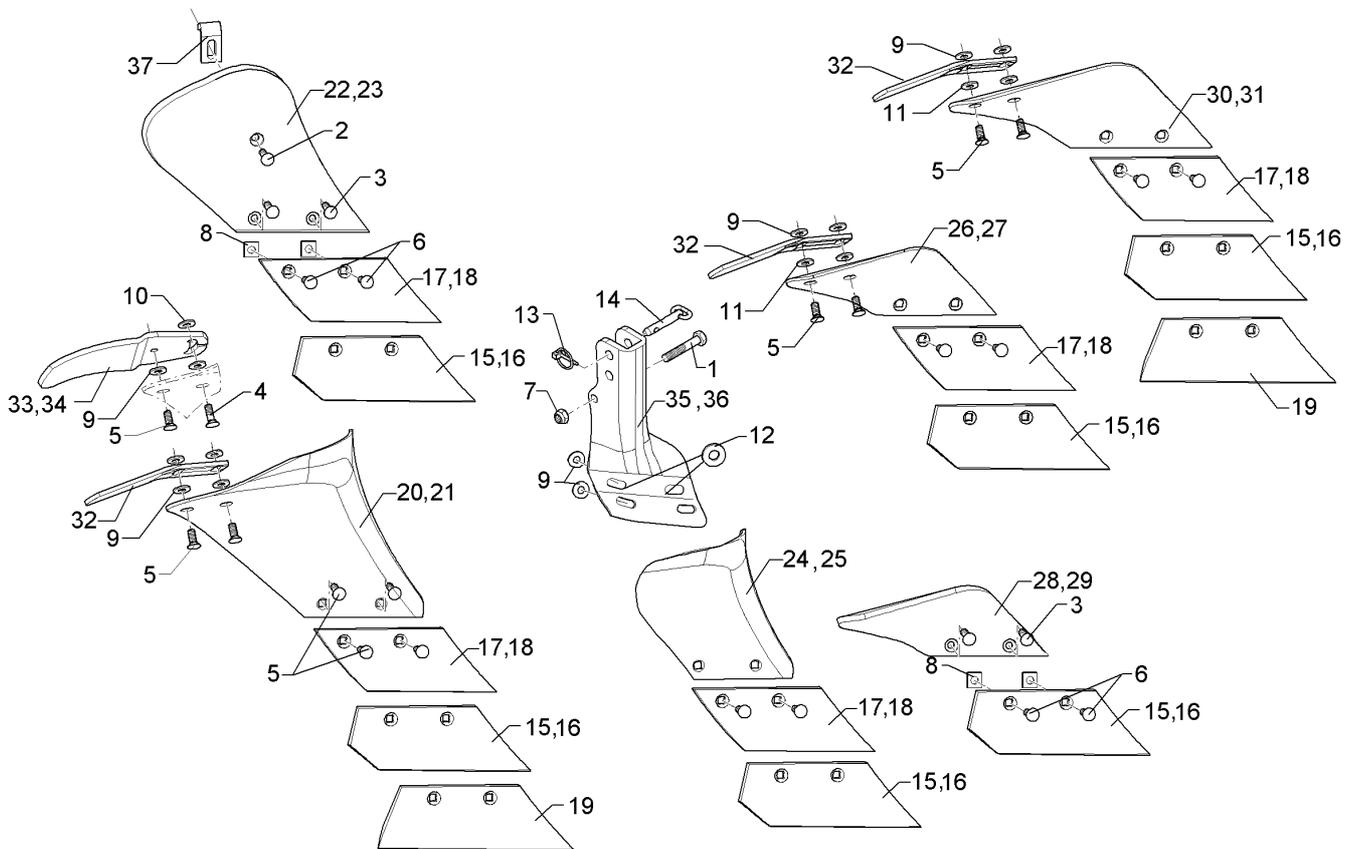

01.18

Pos.	Art.Nr.	Stck.	Artikeltext / Description		Abmessung
42	657 1498	1	Düngereinleger	Skimmer	F50x30-10 D1KU/S270 RE
43	657 1499	1	Düngereinleger	Skimmer	F50x30-10 D1KU/S270 LI
44	657 1500	1	Düngereinleger	Skimmer	F50x30-10 D1/S270 RE
45	657 1501	1	Düngereinleger	Skimmer	F50x30-10 D1/S270 LI
46	657 1502	1	Düngereinleger	Skimmer	F50x30-10 D1/S270 RE+STD1
47	657 1503	1	Düngereinleger	Skimmer	F50x30-10 D1/S270 LI+STD1
48	657 1504	1	Düngereinleger	Skimmer	F50x30-10 D1/S360 RE
49	657 1505	1	Düngereinleger	Skimmer	F50x30-10 D1/S360 LI
50	657 1506	1	Düngereinleger	Skimmer	F50x30-10 D1/S360 RE+STD1
51	657 1507	1	Düngereinleger	Skimmer	F50x30-10 D1/S360 LI+STD1
52	657 1508	1	Düngereinleger	Skimmer	F50x30-10 D0/S270 RE
53	657 1509	1	Düngereinleger	Skimmer	F50x30-10 D0/S270 LI
54	657 1510	1	Düngereinleger	Skimmer	F50x30-10 D0/S270 RE+STD1
55	657 1511	1	Düngereinleger	Skimmer	F50x30-10 D0/S270 LI+STD1

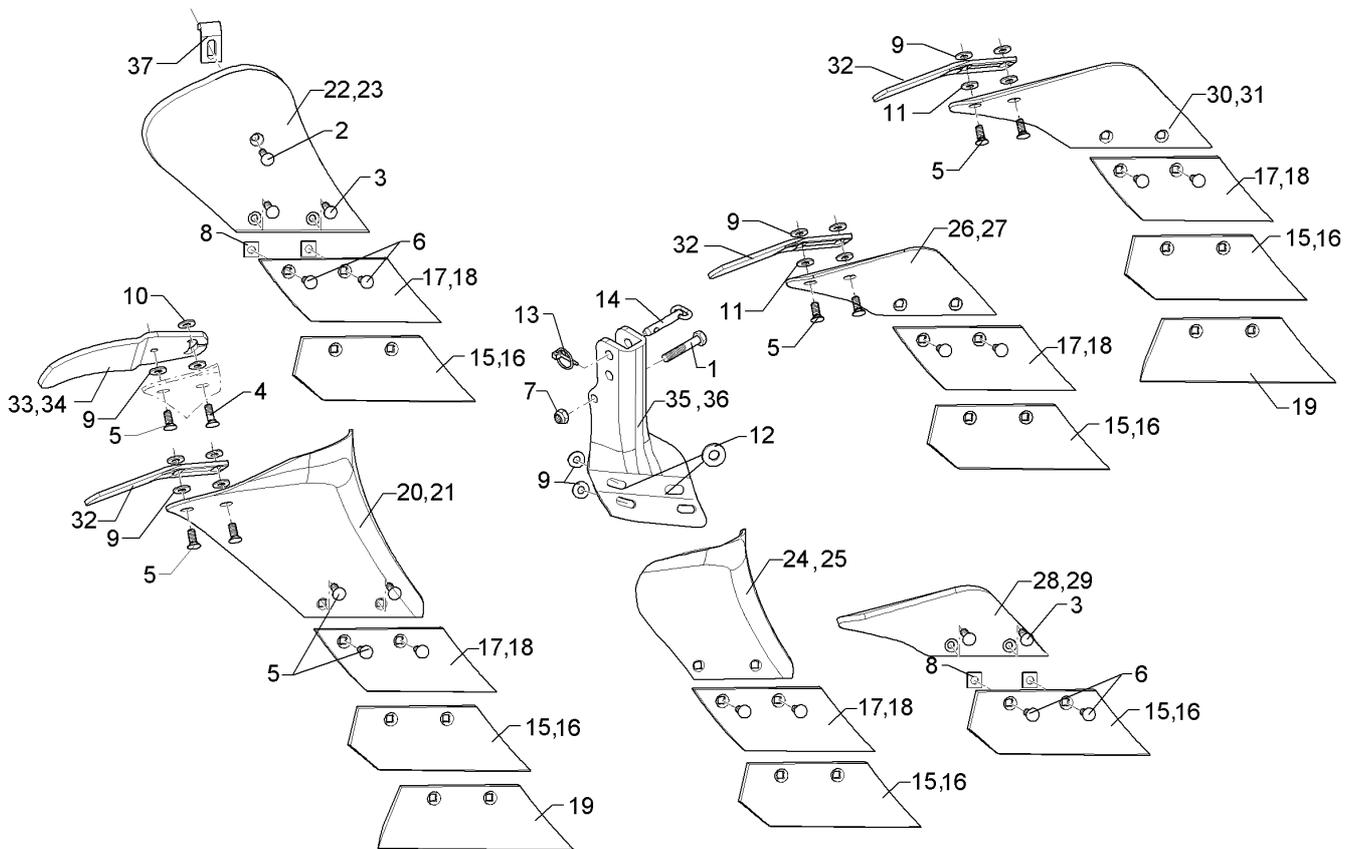

01.18

Pos.	Art.Nr.	Stck.	Artikeltext / Description		Abmessung
56	657 1512	1	Düngereinleger	Skimmer	F50x30-10 D0/S360 RE
57	657 1513	1	Düngereinleger	Skimmer	F50x30-10 D0/S360 LI
58	657 1514	1	Düngereinleger	Skimmer	F50x30-10 D0-S360 RE+STD1
59	657 1515	1	Düngereinleger	Skimmer	F50x30-10 D0/S360 LI+STD1
60	657 1516	1	Düngereinleger	Skimmer	F50x30-10 M2/S270 RE
61	657 1517	1	Düngereinleger	Skimmer	F50x30-10 M2/S270 LI
62	657 1518	1	Düngereinleger	Skimmer	F50x30-10 M2/S270 RE+STD2
63	657 1519	1	Düngereinleger	Skimmer	F50x30-10 M2/S270 LI+STD2
64	657 1520	1	Düngereinleger	Skimmer	F50x30-10 M2/S360 RE
65	657 1521	1	Düngereinleger	Skimmer	F50x30-10 M2/S360 LI
66	657 1522	1	Düngereinleger	Skimmer	F50x30-10 M2/S360 RE+STD2
67	657 1523	1	Düngereinleger	Skimmer	F50x30-10 M2/S360 LI+STD2
68	657 1524	1	Düngereinleger	Skimmer	F50x30-10 M2/S190 RE
69	657 1525	1	Düngereinleger	Skimmer	F50x30-10 M2/S190 LI

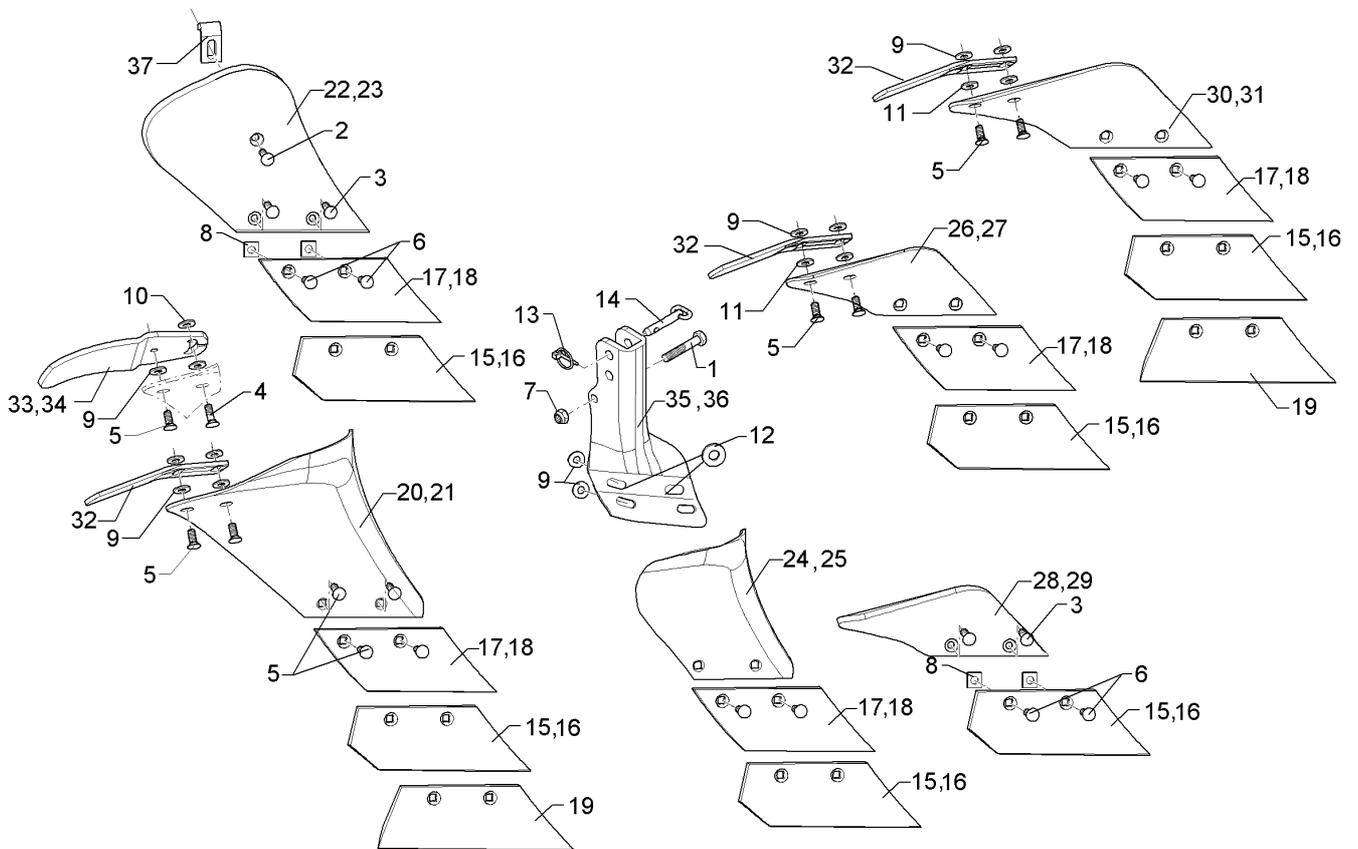

01.18

Pos.	Art.Nr.	Stck.	Artikeltext / Description		Abmessung
70	657 1540	1	Düngereinleger	Skimmer	F50x30-10 M3/S190 RE
71	657 1541	1	Düngereinleger	Skimmer	F50x30-10 M3/S190 LI
72	657 1544	1	Düngereinleger	Skimmer	F50x30-10 M3/S270 RE
73	657 1545	1	Düngereinleger	Skimmer	F50x30-10 M3/S270 LI
74	65710028	1	Düngereinleger	Skimmer	F50x30-10 D0/S190 RE
75	65710029	1	Düngereinleger	Skimmer	F50x30-10 D0/S190 LI
76	65710030	1	Düngereinleger	Skimmer	F50x30-10 D0/S190 RE+STD1
77	65710031	1	Düngereinleger	Skimmer	F50x30-10 D0/S190 LI+STD1
78	65710078	1	Düngereinleger	Skimmer	F50x30-10 D1/S190 RE
79	65710079	1	Düngereinleger	Skimmer	F50x30-10 D1/S190 LI
80	65710148	1	Düngereinleger	Skimmer	F50x30-10 D1/S190 RE+STD1
81	65710149	1	Düngereinleger	Skimmer	F50x30-10 D1/S190 LI+STD1

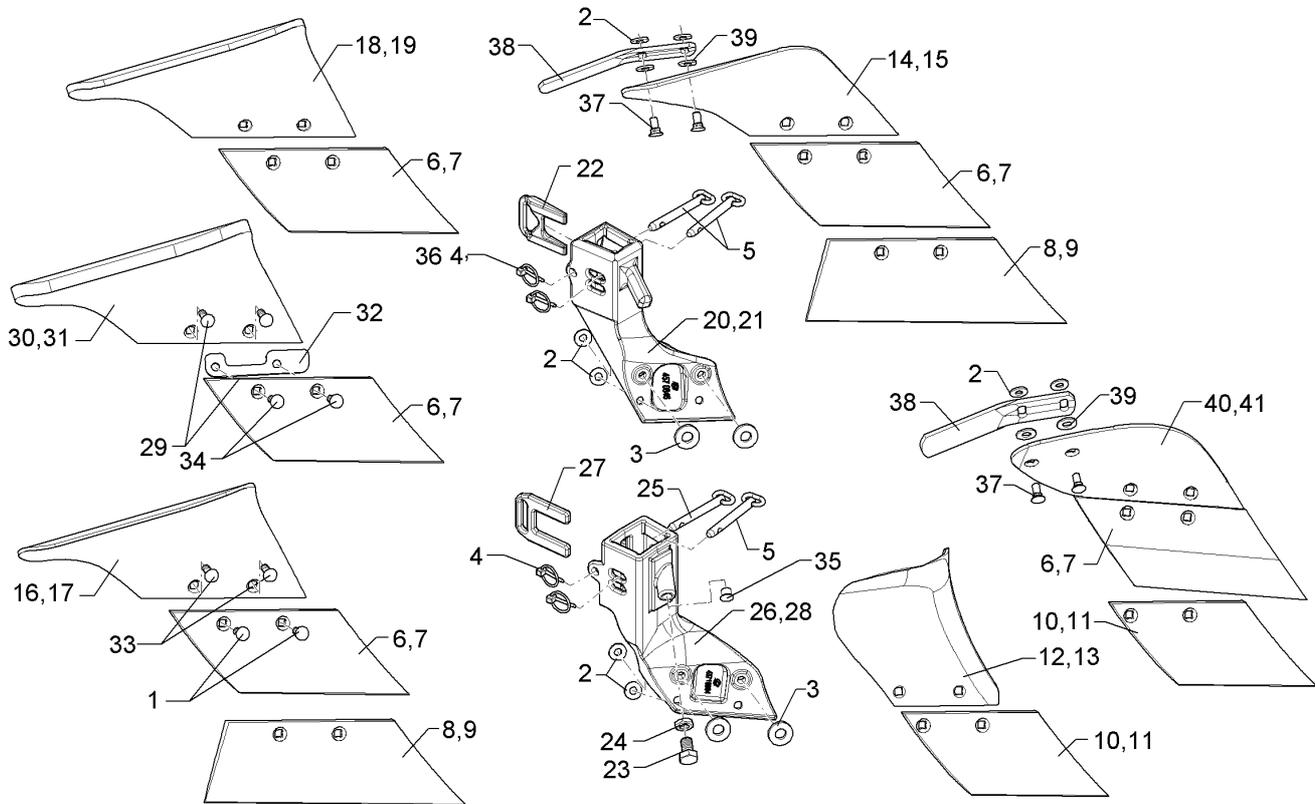

01.18

Pos.	Art.Nr.	Stck.	Artikeltext / Description		Abmessung
1	301 5767	4	Senkschraube	Countersunk bolt	M10x33-12.9-MU-10 Zn
2	305 6132	4	Scheibe	Washer	D11/25x2,5 Zn
3	305 7703	2	Scheibe Graupappe	Washer	D35/16x5
4	311 9565	2	Klappstift	Securing pin	4,5
5	313 8153	2	Bolzen mit Griff	Pin with grip	D12x74,5/115 Zn
6	336 3722	1	Schar	Share	S245 RE
7	336 3723	1	Schar	Share	S245 LI
8	336 3726	1	Schar	Share	S370 RE
9	336 3727	1	Schar	Share	S370 LI
10	336 3728	1	Schar	Share	S205 RE
11	336 3729	1	Schar	Share	S205 LI
12	347 0620	1	Streichblech	Mouldboard	M3 RE
13	347 0621	1	Streichblech	Mouldboard	M3 LI
14	347 0654	1	Streichblech	Mouldboard	D0 RE
15	347 0655	1	Streichblech	Mouldboard	D0 LI
16	347 0660	1	Streichblech	Mouldboard	MS1 RE
17	347 0661	1	Streichblech	Mouldboard	MS1 LI
18	347 0662	1	Streichblech	Mouldboard	MS1 KU RE
19	347 0663	1	Streichblech	Mouldboard	MS1 KU LI
20	457 0846	1	Körperrumpf	Frog	DE 50x30 RE
21	457 0847	1	Körperrumpf	Frog	DE 50x30 LI
22	457 0850	1	Keil	Wedge	17x70x85 9GRD

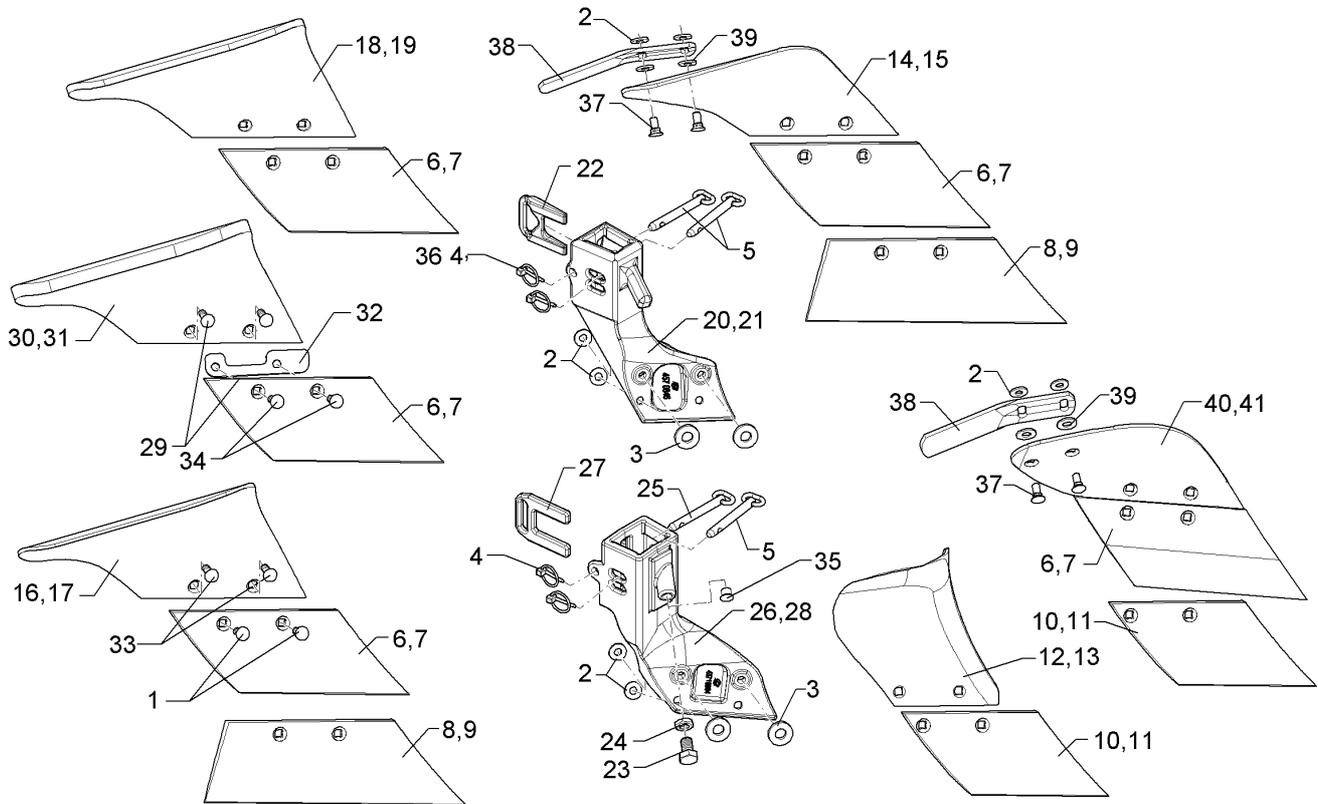

01.18

Pos.	Art.Nr.	Stck.	Artikeltext / Description		Abmessung
23	301 3682	1	Sechskantschraube	Hexagon bolt	M16x30-8.8 Zn DIN933
24	303 1020	1	Sechskantmutter	Hexagon nut	M16 DIN936-8 Zn
25	31310003	1	Bolzen mit Griff	Pin with grip	D12x95,5/135 Zn
26	45710004	1	Körperrumpf	Frog	DE RE 50x30 1xM16
27	45710006	1	Riegel	Locking bar	DE 10x78x95 Zn
28	45710005	1	Körperrumpf	Frog	DE LI 50x30 1xM16
29	301 5722	4	Senkschraube	Countersunk bolt	M10x45x4-12.9 Zn
30	34710002	1	Streichblech	Mouldboard	MS1 KU RE
31	34710003	1	Streichblech	Mouldboard	MS1 KU LI
32	45710007	1	Unterlage	Plate	6x33x147 2xD12-87 Zn
33	301 5773	2	Senkschraube	Countersunk bolt	M10x35-8.8-MU Zn DIN608
34	301 5769	2	Senkschraube	Countersunk bolt	M10x45-12.9-MU-10 Zn
35	323 8072	1	Schutzkappe	Cap	GPN 300V142- D16 RAL5015
36	311 9568	2	Sicherheitsklapstecker	Securing pin	5x32 d1=4,7 Zn
37	301 5771	2	Senkschraube	Countersunk bolt	M10x25-8.8-MU Zn DIN608
38	347 3650	1	Streichblech	Tail piece	STD1 60x6x230
39	305 8580	2	Scheibe	Washer	13/24x2,5 St-Zn DIN125
40	347 0650	1	Streichblech	Mouldboard	D1 RE
41	347 0651	1	Streichblech	Mouldboard	D1 LI

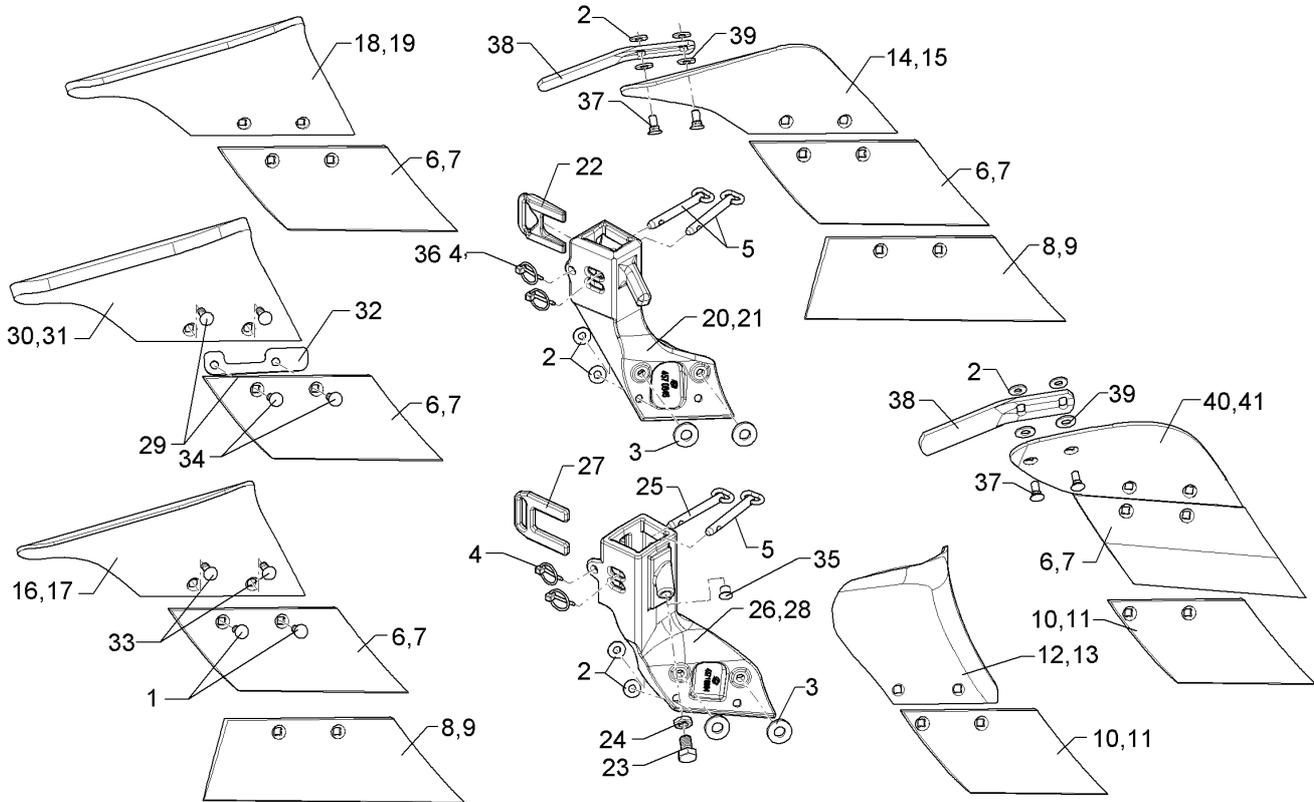

01.18

Pos.	Art.Nr.	Stck.	Artikeltext / Description		Abmessung
42	657 1650	1	Düngereinleger	Skimmer	50x30 MS1/S245 RE
43	657 1651	1	Düngereinleger	Skimmer	50x30 MS1/S245 LI
44	657 1652	1	Düngereinleger	Skimmer	50x30 MS1/S370 RE
45	657 1653	1	Düngereinleger	Skimmer	50x30 MS1/S370 LI
46	657 1654	1	Düngereinleger	Skimmer	50x30 MS1-KU/S245 LI
47	657 1655	1	Düngereinleger	Skimmer	50x30 MS1-KU/S245 RE
48	657 1656	1	Düngereinleger	Skimmer	50x30 DS0/S245 RE
49	657 1657	1	Düngereinleger	Skimmer	50x30 DS0/S245 LI
50	657 1658	1	Düngereinleger	Skimmer	50x30 MS3/S205 RE
51	657 1659	1	Düngereinleger	Skimmer	50x30 MS3/S205 LI
52	65710002	1	Düngereinleger	Skimmer	50x30 MS1-B/S245 RE
53	65710003	1	Düngereinleger	Skimmer	50x30 MS1-B/S245 LI
54	65710004	1	Düngereinleger	Skimmer	50x30 MS1-B/S370 RE
55	65710005	1	Düngereinleger	Skimmer	50x30 MS1-B/S370 LI
56	65710006	1	Düngereinleger	Skimmer	50x30 MS1-KU-B/S245 RE
57	65710007	1	Düngereinleger	Skimmer	50x30 MS1-KU-B/S245 LI
58	65710008	1	Düngereinleger	Skimmer	50x30 DS0-B/S245 RE

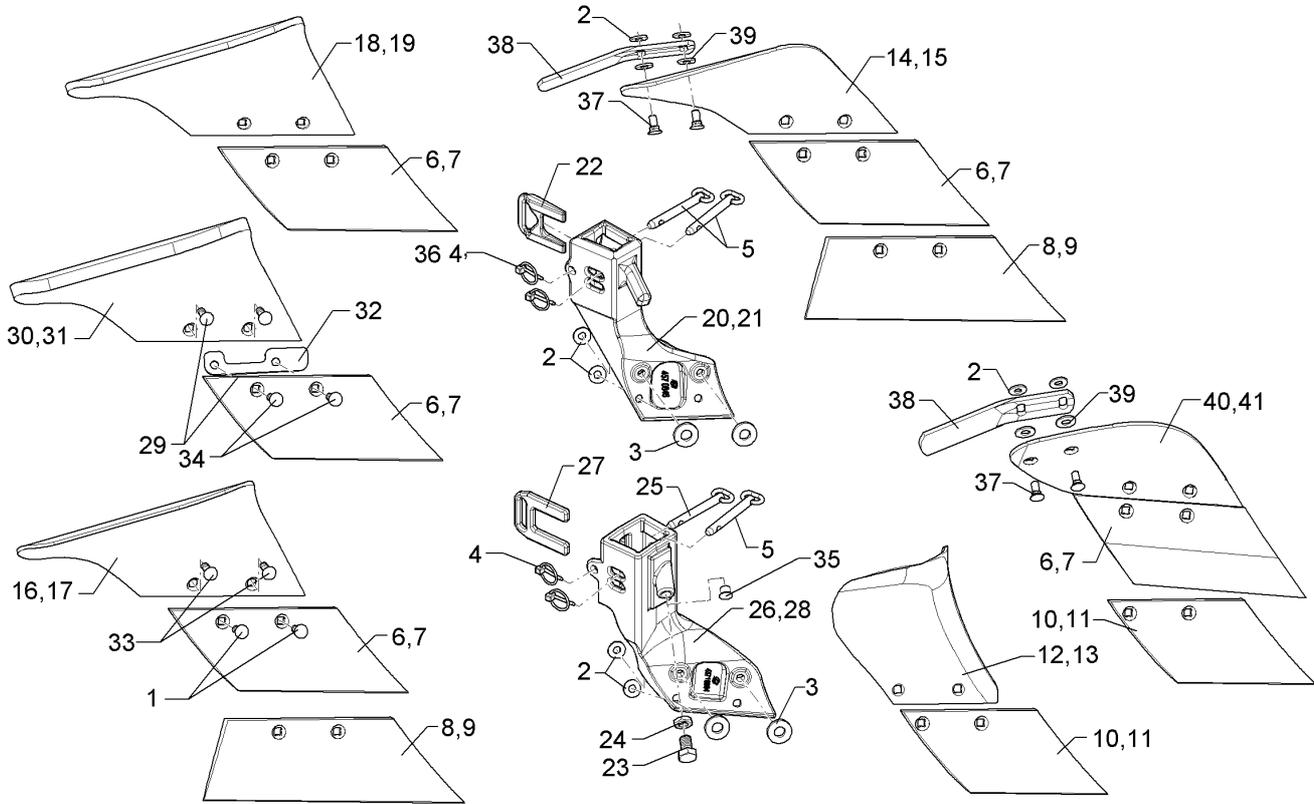

01.18

Pos.	Art.Nr.	Stck.	Artikeltext / Description		Abmessung
59	65710009	1	Düngereinleger	Skimmer	50x30 DS0-B/S245 LI
60	65710010	1	Düngereinleger	Skimmer	50x30 MS3-B/S205 RE
61	65710011	1	Düngereinleger	Skimmer	50x30 MS3-B/S205 LI
62	65710044	1	Düngereinleger	Skimmer	50x30 MS3-B/S245 RE
63	65710045	1	Düngereinleger	Skimmer	50x30 MS3-B/S245 LI
64	65710046	1	Düngereinleger	Skimmer	50x30 DS0-B/S245 +STD RE
65	65710047	1	Düngereinleger	Skimmer	50x30 DS0-B/S245 +STD LI
66	65710050	1	Düngereinleger	Skimmer	50x30 DS1-B/S245 RE
67	65710051	1	Düngereinleger	Skimmer	50x30 DS1-B/S245 LI
68	65710052	1	Düngereinleger	Skimmer	50x30 DS1-B/S205 RE
69	65710053	1	Düngereinleger	Skimmer	50x30 DS1-B/S205 LI
70	65710054	1	Düngereinleger	Skimmer	50x30 DS1-B/S245 +STD RE
71	65710055	1	Düngereinleger	Skimmer	50x30 DS1-B/S245 +STD LI
72	65710056	1	Düngereinleger	Skimmer	50x30 DS1-B/S205 +STD RE

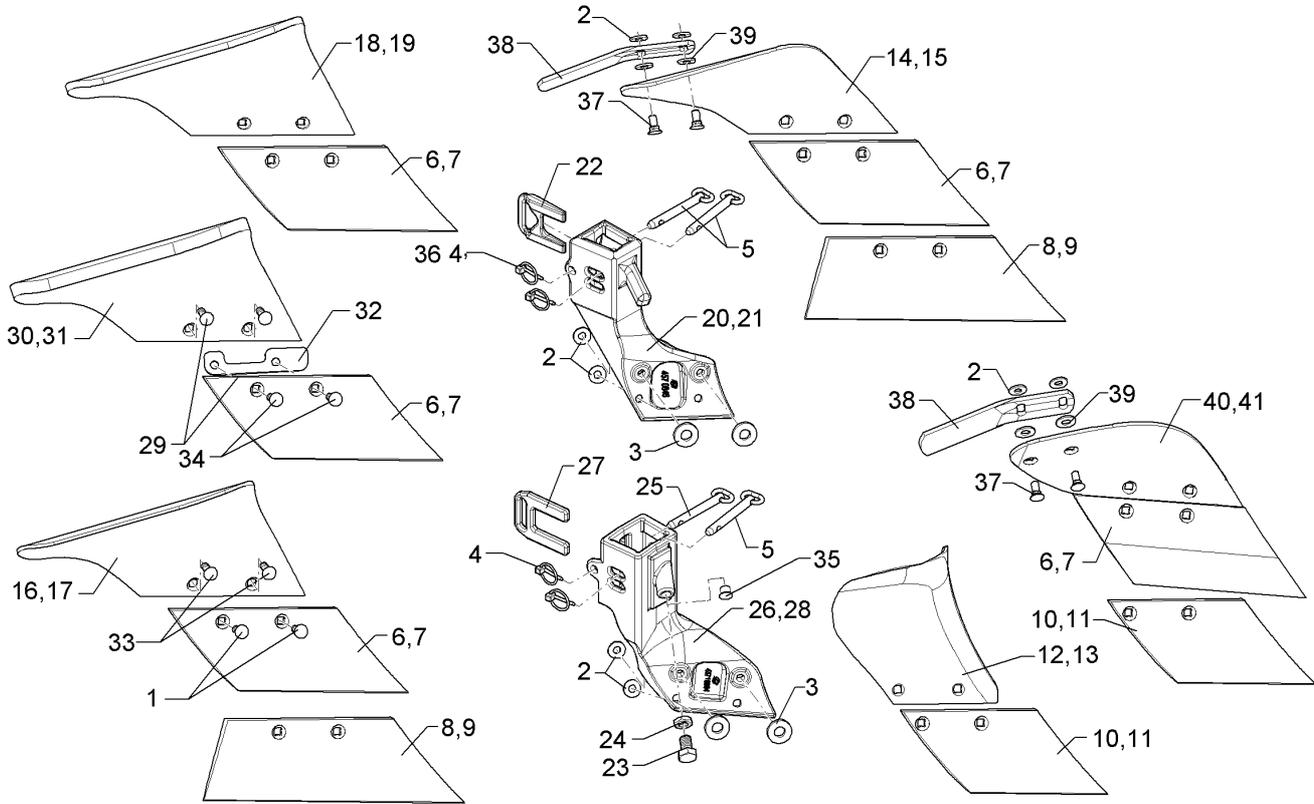

01.18

Pos.	Art.Nr.	Stck.	Artikeltext / Description		Abmessung
73	65710057	1	Düngereinleger	Skimmer	50x30 DS1-B/S205 +STD LI
74	65710064	1	Düngereinleger	Skimmer	50x30 DS0-B/S370 RE
75	65710065	1	Düngereinleger	Skimmer	50x30 DS0-B/S370 LI
76	65710066	1	Düngereinleger	Skimmer	50x30 DS0-B/S370 +STD RE
77	65710067	1	Düngereinleger	Skimmer	50x30 DS0-B/S370 +STD LI
78	65710068	1	Düngereinleger	Skimmer	50x30 MS3-B/S370 RE
79	65710069	1	Düngereinleger	Skimmer	50x30 MS3-B/S370 LI
80	65710070	1	Düngereinleger	Skimmer	50x30 DS0-B/S205 RE
81	65710071	1	Düngereinleger	Skimmer	50x30 DS0-B/S205 LI
82	65710072	1	Düngereinleger	Skimmer	50x30 DS0-B/S205 +STD RE
83	65710073	1	Düngereinleger	Skimmer	50x30 DS0-B/S205 +STD LI

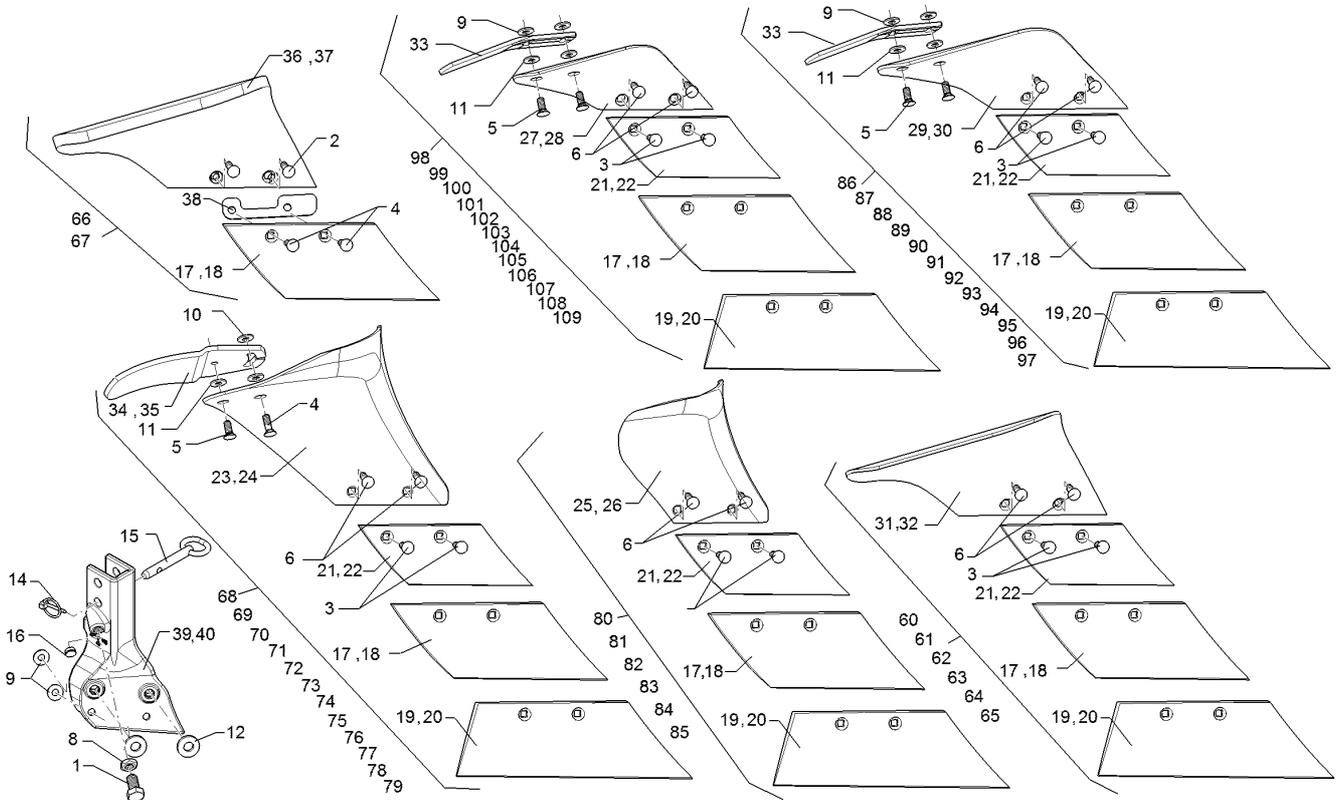

01.18

Pos.	Art.Nr.	Stck.	Artikeltext / Description		Abmessung
1	301 3682	1	Sechskantschraube	Hexagon bolt	M16x30-8.8 Zn DIN933
2	301 5722	2	Senkschraube	Countersunk bolt	M10x45x4-12.9 Zn
3	301 5767	2	Senkschraube	Countersunk bolt	M10x33-12.9-MU-10 Zn
4	301 5769	2	Senkschraube	Countersunk bolt	M10x45-12.9-MU-10 Zn
5	301 5771	1	Senkschraube	Countersunk bolt	M10x25-8.8-MU Zn DIN608
6	301 5773	2	Senkschraube	Countersunk bolt	M10x35-8.8-MU Zn DIN608
7	303 1012	2	Sechskantmutter	Hexagon nut	M10 DIN934-8 Zn
8	303 1020	1	Sechskantmutter	Hexagon nut	M16 DIN936-8 Zn
9	305 6132	4	Scheibe	Washer	D11/25x2,5 Zn
10	305 6134	1	Scheibe	Washer	D25/11x5 Zn
11	305 6135	2	Scheibe	Washer	13x28x2,5 DIN 134
12	305 7701	2	Scheibe Graupappe	Washer	D16,5/35x3
13	305 8580	2	Scheibe	Washer	13/24x2,5 St-Zn DIN125
14	311 9565	1	Klappstift	Securing pin	4,5
15	313 8158	1	Bolzen mit Griff	Pin with grip	D14x61/103 Zn
16	323 8072	1	Schutzkappe	Cap	GPN 300V142- D16 RAL5015
17	336 3722	1	Schar	Share	S245 RE
18	336 3723	1	Schar	Share	S245 LI
19	336 3726	1	Schar	Share	S370 RE

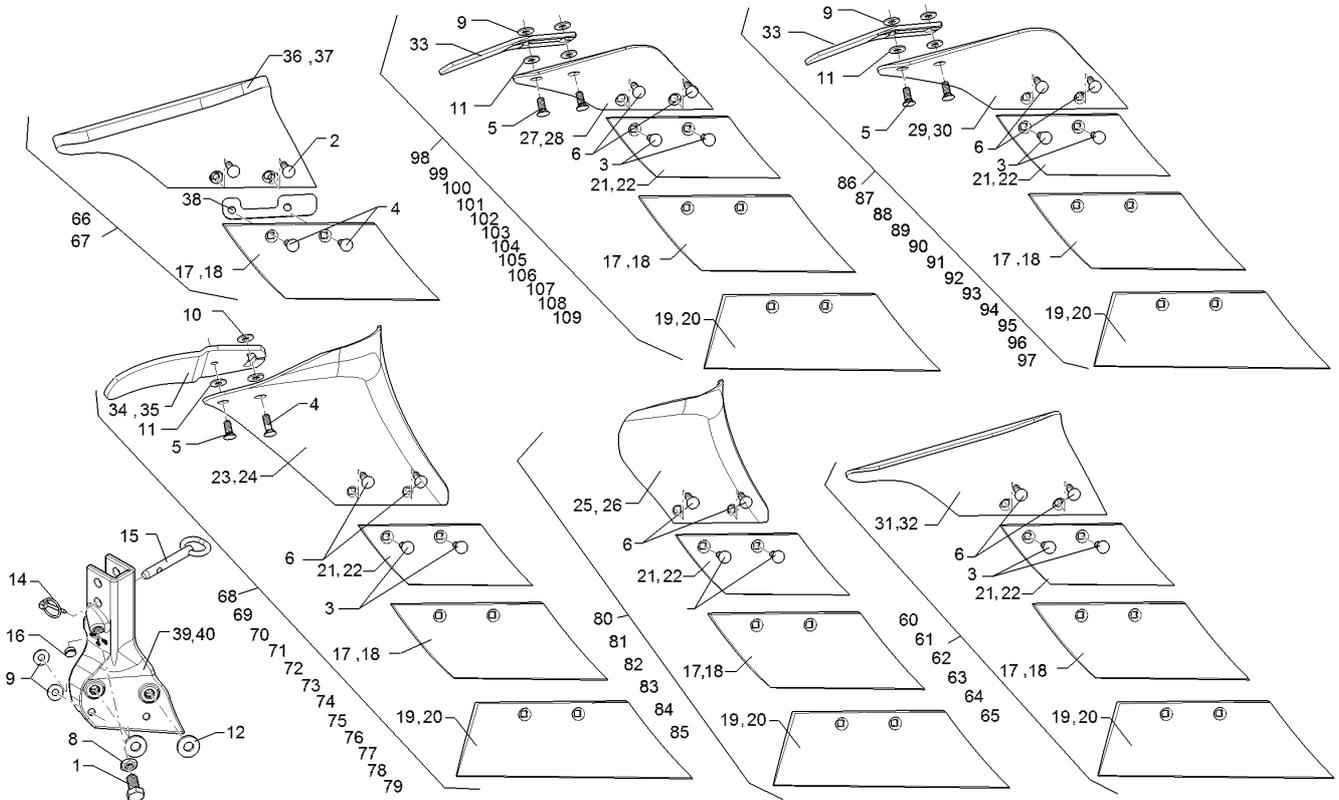

01.18

Pos.	Art.Nr.	Stck.	Artikeltext / Description		Abmessung
20	336 3727	1	Schar	Share	S370 LI
21	336 3728	1	Schar	Share	S205 RE
22	336 3729	1	Schar	Share	S205 LI
23	347 0600	1	Streichblech	Mouldboard	M2 RE
24	347 0601	1	Streichblech	Mouldboard	M2 LI
25	347 0620	1	Streichblech	Mouldboard	M3 RE
26	347 0621	1	Streichblech	Mouldboard	M3 LI
27	347 0650	1	Streichblech	Mouldboard	D1 RE
28	347 0651	1	Streichblech	Mouldboard	D1 LI
29	347 0654	1	Streichblech	Mouldboard	D0 RE
30	347 0655	1	Streichblech	Mouldboard	D0 LI
31	347 0660	1	Streichblech	Mouldboard	MS1 RE
32	347 0661	1	Streichblech	Mouldboard	MS1 LI
33	347 3650	1	Streichschiene	Tail piece	STD1 60x6x230
34	347 3652	1	Streichschiene	Tail piece	STD2 RE
35	347 3653	1	Streichschiene	Tail piece	STD2 LI
36	34710002	1	Streichblech	Mouldboard	MS1 KU RE
37	34710003	1	Streichblech	Mouldboard	MS1 KU LI
38	45710007	1	Unterlage	Plate	6x33x147 2xD12-87 Zn
39	45710046	1	Körperrumpf	Frog	DE RE 50x30-G 1xM16
40	45710047	1	Körperrumpf	Frog	DE LI 50x30-G 1xM16

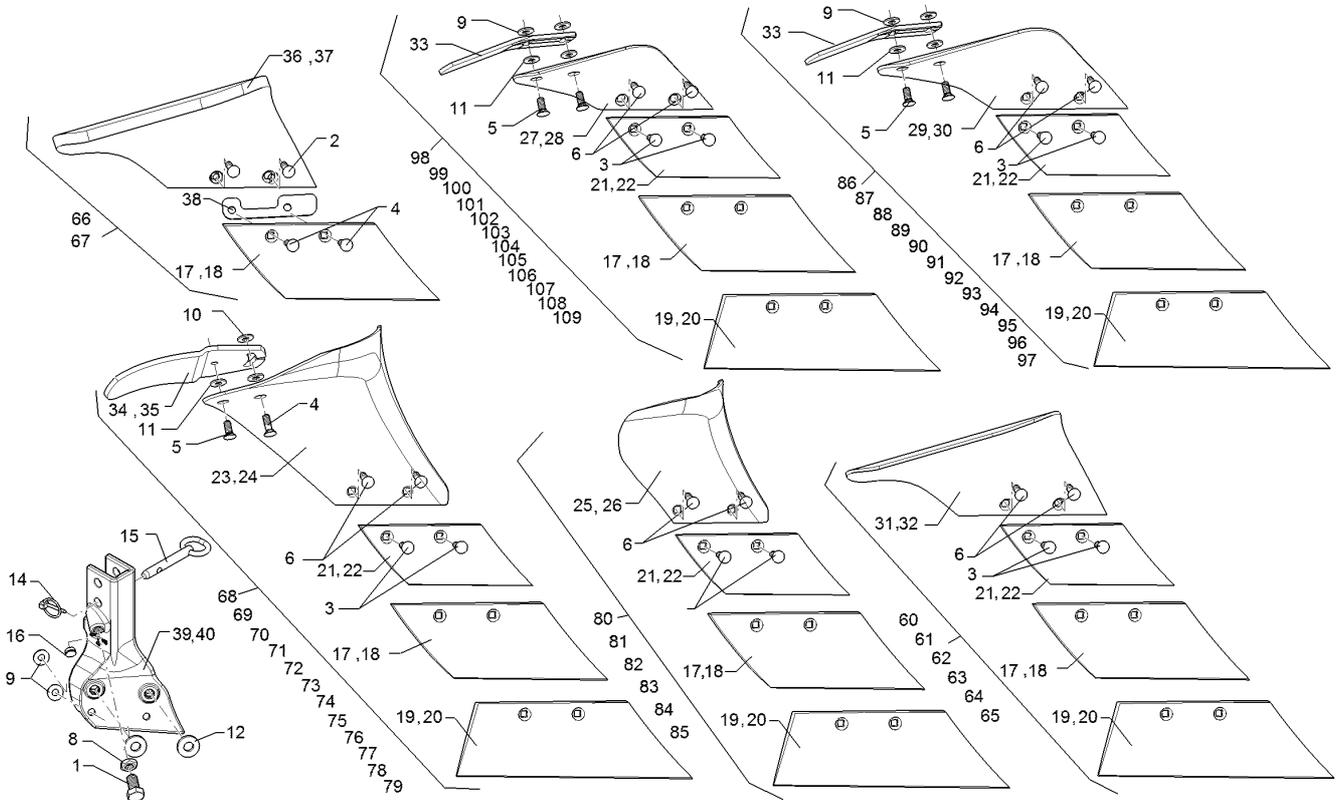

01.18

Pos.	Art.Nr.	Stck.	Artikeltext / Description		Abmessung
60	65710084	1	Düngereinleger	Skimmer	50x30-G MS1/S205 RE
61	65710085	1	Düngereinleger	Skimmer	50x30-G MS1/S205 LI
62	65710086	1	Düngereinleger	Skimmer	50x30-G MS1/S245 RE
63	65710087	1	Düngereinleger	Skimmer	50x30-G MS1/S245 LI
64	65710088	1	Düngereinleger	Skimmer	50x30-G MS1/S370 RE
65	65710089	1	Düngereinleger	Skimmer	50x30-G MS1/S370 LI
66	65710090	1	Düngereinleger	Skimmer	50x30-G MS1-KU/S245 RE
67	65710091	1	Düngereinleger	Skimmer	50x30-G MS1-KU/S245 LI
68	65710092	1	Düngereinleger	Skimmer	50x30-G MS2/S205 RE
69	65710093	1	Düngereinleger	Skimmer	50x30-G MS2/S205 LI
70	65710094	1	Düngereinleger	Skimmer	50x30-G MS2/S245 RE
71	65710095	1	Düngereinleger	Skimmer	50x30-G MS2/S245 LI
72	65710096	1	Düngereinleger	Skimmer	50x30-G MS2/S370 RE
73	65710097	1	Düngereinleger	Skimmer	50x30-G MS2/S370 LI

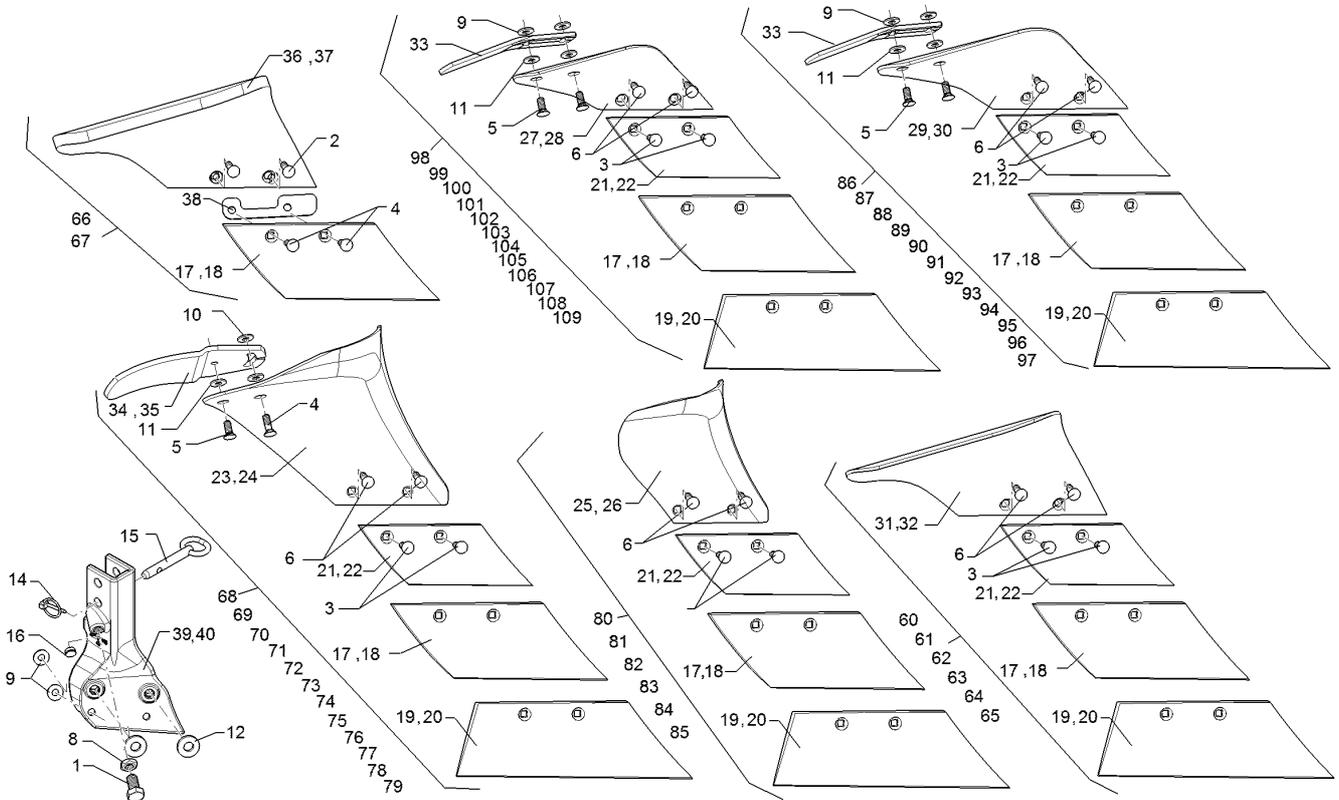

01.18

Pos.	Art.Nr.	Stck.	Artikeltext / Description		Abmessung
74	65710098	1	Düngereinleger	Skimmer	50x30-G MS2/S205+STD2 RE
75	65710099	1	Düngereinleger	Skimmer	50x30-G MS2/S205+STD2 LI
76	65710100	1	Düngereinleger	Skimmer	50x30-G MS2/S245+STD2 RE
77	65710101	1	Düngereinleger	Skimmer	50x30-G MS2/S245+STD2 LI
78	65710102	1	Düngereinleger	Skimmer	50x30-G MS2/S370+STD2 RE
79	65710103	1	Düngereinleger	Skimmer	50x30-G MS2/S370+STD2 LI
80	65710104	1	Düngereinleger	Skimmer	50x30-G MS3/S205 RE
81	65710105	1	Düngereinleger	Skimmer	50x30-G MS3/S205 LI
82	65710114	1	Düngereinleger	Skimmer	50x30-G MS3/S245 RE
83	65710115	1	Düngereinleger	Skimmer	50x30-G MS3/S245 LI
84	65710116	1	Düngereinleger	Skimmer	50x30-G MS3/S370 RE
85	65710117	1	Düngereinleger	Skimmer	50x30-G MS3/S370 LI
86	65710118	1	Düngereinleger	Skimmer	50x30-G DS0/S205 RE

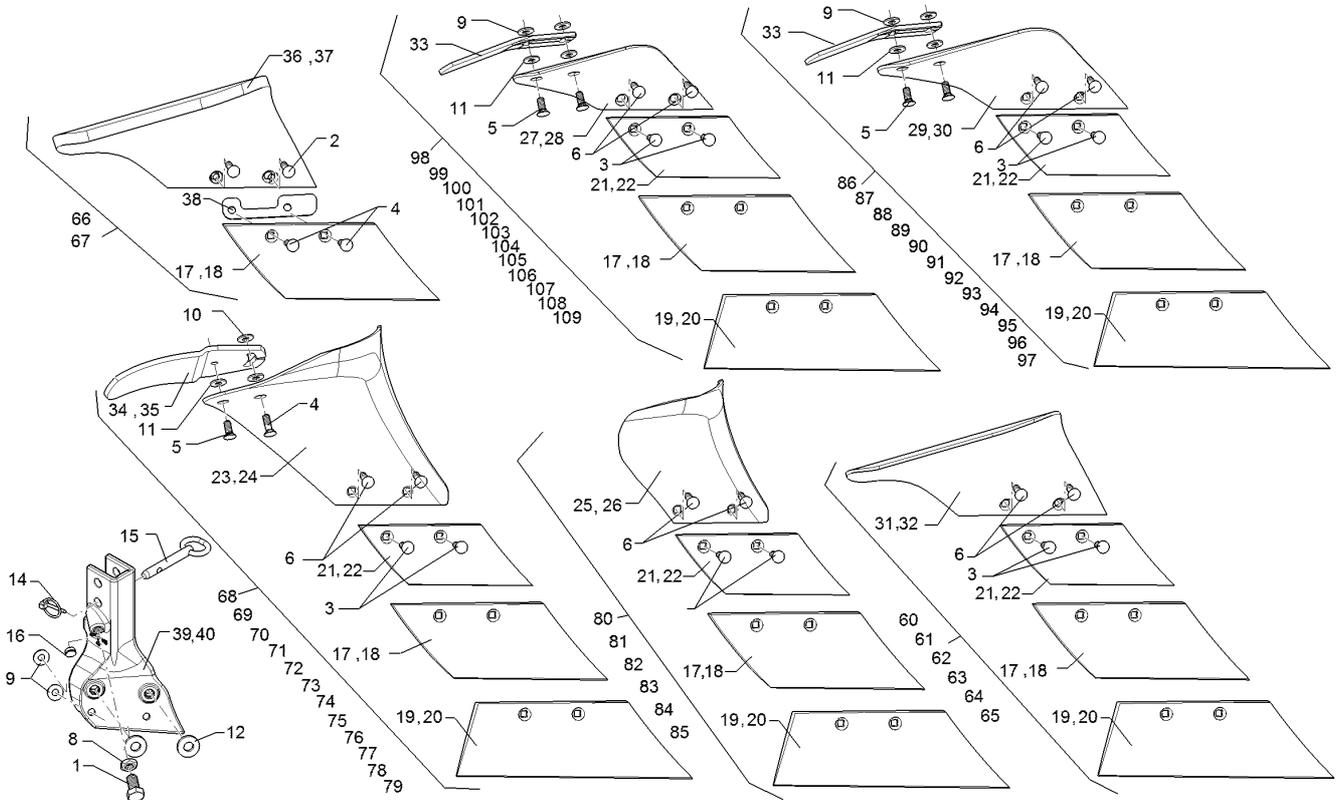

01.18

Pos.	Art.Nr.	Stck.	Artikeltext / Description		Abmessung
87	65710119	1	Düngereinleger	Skimmer	50x30-G DS0/S205 LI
88	65710120	1	Düngereinleger	Skimmer	50x30-G DS0/S245 RE
89	65710121	1	Düngereinleger	Skimmer	50x30-G DS0/S245 LI
90	65710122	1	Düngereinleger	Skimmer	50x30-G DS0/S370 RE
91	65710123	1	Düngereinleger	Skimmer	50x30-G DS0/S370 LI
92	65710124	1	Düngereinleger	Skimmer	50x30-G DS0/S205+STD1 RE
93	65710125	1	Düngereinleger	Skimmer	50x30-G DS0/S205+STD1 LI
94	65710126	1	Düngereinleger	Skimmer	50x30-G DS0/S245+STD1 RE
95	65710127	1	Düngereinleger	Skimmer	50x30-G DS0/S245+STD1 LI
96	65710128	1	Düngereinleger	Skimmer	50x30-G DS0/S370+STD1 RE
97	65710129	1	Düngereinleger	Skimmer	50x30-G DS0/S370+STD1 LI
98	65710130	1	Düngereinleger	Skimmer	50x30-G DS1/S205 RE
99	65710131	1	Düngereinleger	Skimmer	50x30-G DS1/S205 LI
100	65710132	1	Düngereinleger	Skimmer	50x30-G DS1/S245 RE

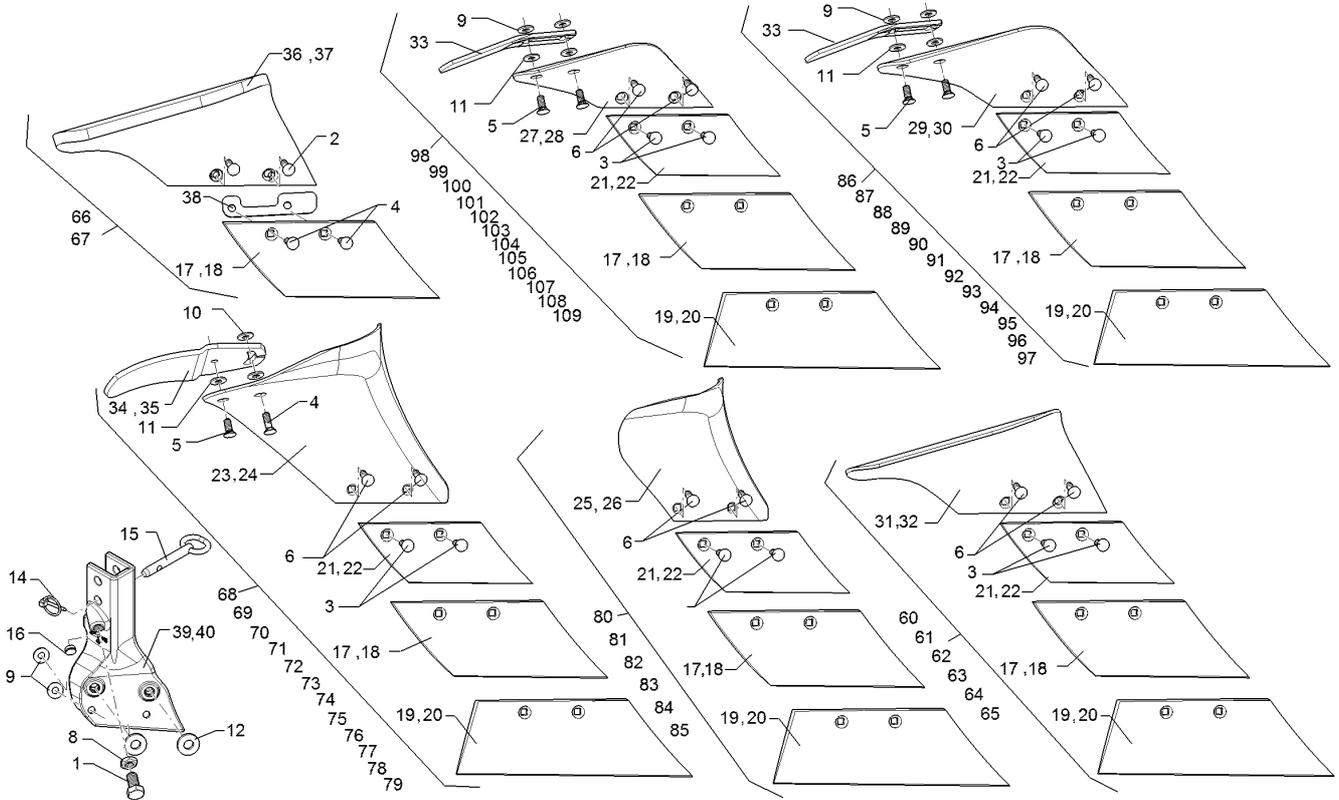

01.18

Pos.	Art.Nr.	Stck.	Artikeltext / Description		Abmessung
101	65710133	1	Düngereinleger	Skimmer	50x30-G DS1/S245 LI
102	65710134	1	Düngereinleger	Skimmer	50x30-G DS1/S370 RE
103	65710135	1	Düngereinleger	Skimmer	50x30-G DS1/S370 LI
104	65710136	1	Düngereinleger	Skimmer	50x30-G DS1/S205+STD1 RE
105	65710137	1	Düngereinleger	Skimmer	50x30-G DS1/S205+STD1 LI
106	65710138	1	Düngereinleger	Skimmer	50x30-G DS1/S245+STD1 RE
107	65710139	1	Düngereinleger	Skimmer	50x30-G DS1/S245+STD1 LI
108	65710140	1	Düngereinleger	Skimmer	50x30-G DS1/S370+STD1 RE
109	65710141	1	Düngereinleger	Skimmer	50x30-G DS1/S370+STD1 LI