

Spare Parts List

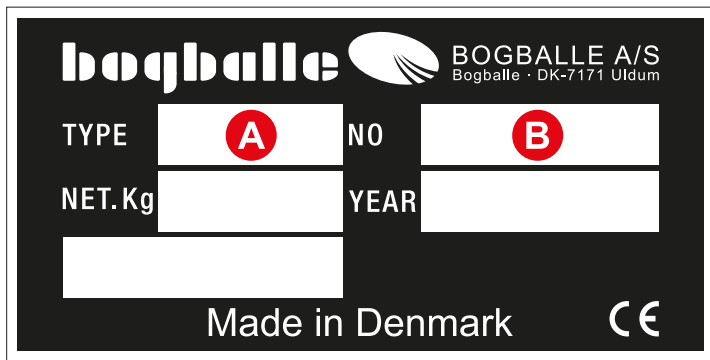

Spreaders + Equipment

Model and serial number

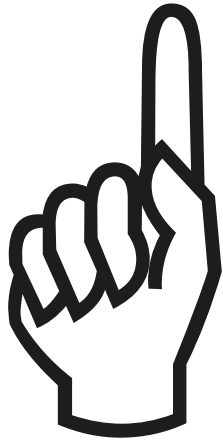

TYPE A	NO B
M6W D	>101
M3W D	>101
M2W D	>101
L2W	>101
M3 D	>101
M2 D	>101
L2	>101
L1 A	>101

Table of Contents

M6W

Chassis.....	6
Weighing frame	16
Hopper with outlet shutters.....	24
Hopper.....	30
Transmission	34
Spreading system.....	36
Regulation system.....	44

M3W

Chassis.....	8
Weighing frame	18
Hopper with outlet shutters.....	24
Hopper.....	32
Transmission	34
Spreading system.....	38
Regulation system.....	46

M3

Chassis.....	8
Hopper with outlet shutters.....	24
Hopper.....	32
Transmission	34
Spreading system.....	38
Regulation system.....	46

M2W

Chassis.....	10
Weighing frame	20
Hopper with outlet shutters.....	24
Hopper.....	32
Transmission	34
Spreading system.....	38
Regulation system.....	46

M2

Chassis.....	10
Hopper with outlet shutters.....	24
Hopper.....	32
Transmission	34
Spreading system.....	38
Regulation system.....	46

L2W

Chassis.....	12
Weighing frame	22
Hopper with outlet shutters.....	26
Hopper.....	26
Transmission	40
Spreading system.....	40
Regulation system.....	48

Table of Contents

L2	
Chassis.....	12
Hopper with outlet shutters.....	26
Hopper.....	26
Transmission	40
Spreading system.....	40
Regulation system.....	48
L1	
Chassis.....	14
Hopper with outlet shutters.....	28
Hopper.....	28
Transmission	42
Spreading system.....	42
Regulation system.....	48
Trails	
M3-Trail	50
M2-Trail	52
L2-Trail	52
BXL 1300	
Hydraulic components	54
Notes	
Notes	58

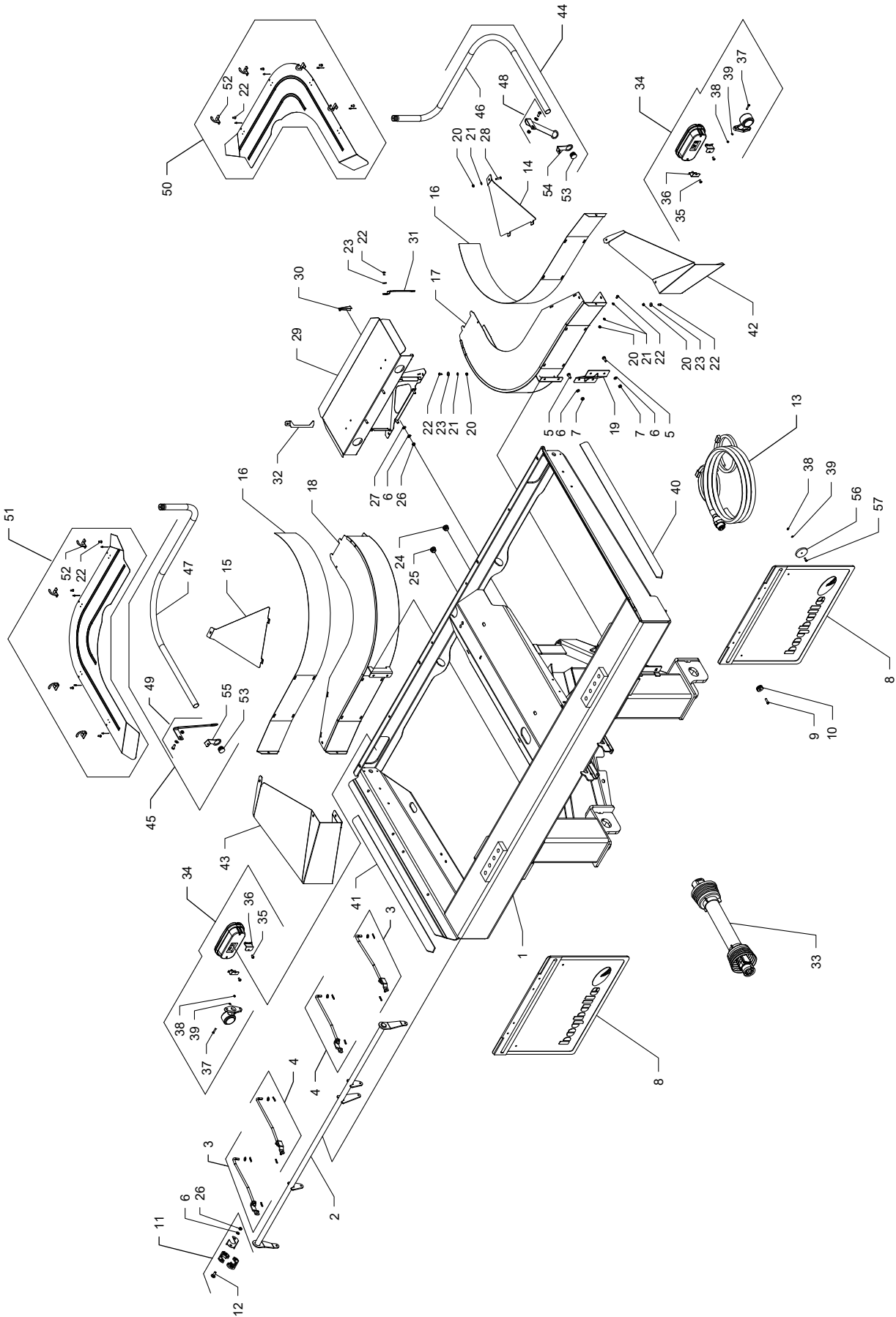

Pos. No.	Order no.	Notes.	Pos. No.	Order no.	Notes.
1	6420-20	M6W	47	6230-06	Right
2	6340-01		48	6230-15	Left
3	6341-05		49	6230-16	Righth
4	6341-06		50	6231-23	Left
5	9962-04	M8x20	51	6231-24	Right
6	9930-32	D8/16	52	6231-30	
7	9969-32	M8 Loc	53	9990-12	
8	4970-81		54	6431-01	Left
9	9961-14	M6x25	55	6431-02	Right
10	9990-43		56	9943-27	White
11	6340-05		57	9929-15	M5x16
12	9962-17	M8x25			
13	6930-22				
14	6371-15	Left			
15	6371-16	Right			
16	6371-10				
17	6371-01	Left			
18	6371-02	Right			
19	6471-01				
20	9969-16	M6 Loc			
21	9930-02	D6/12			
22	9961-20	M6x12			
23	9930-03	D6/18			
24	6350-12				
25	9990-08				
26	9969-32	M8 Loc			
27	9930-51	D8/17			
28	9961-28	M6x25			
29	6372-01				
30	6372-15				
31	6372-10	Left			
32	6372-11	Right			
33	9985-40	810mm			
34	6940-03				
35	9961-29	M6x12			
36	6930-33				
37	9929-19	M5x25			
38	9968-79	M5			
39	9930-39	D5/10			
40	6310-13	Left			
41	6310-14	Right			
42	6930-92	Left			
43	6930-93	Right			
44	6431-05	Left			
45	6431-06	Right			
46	6230-05	Left			

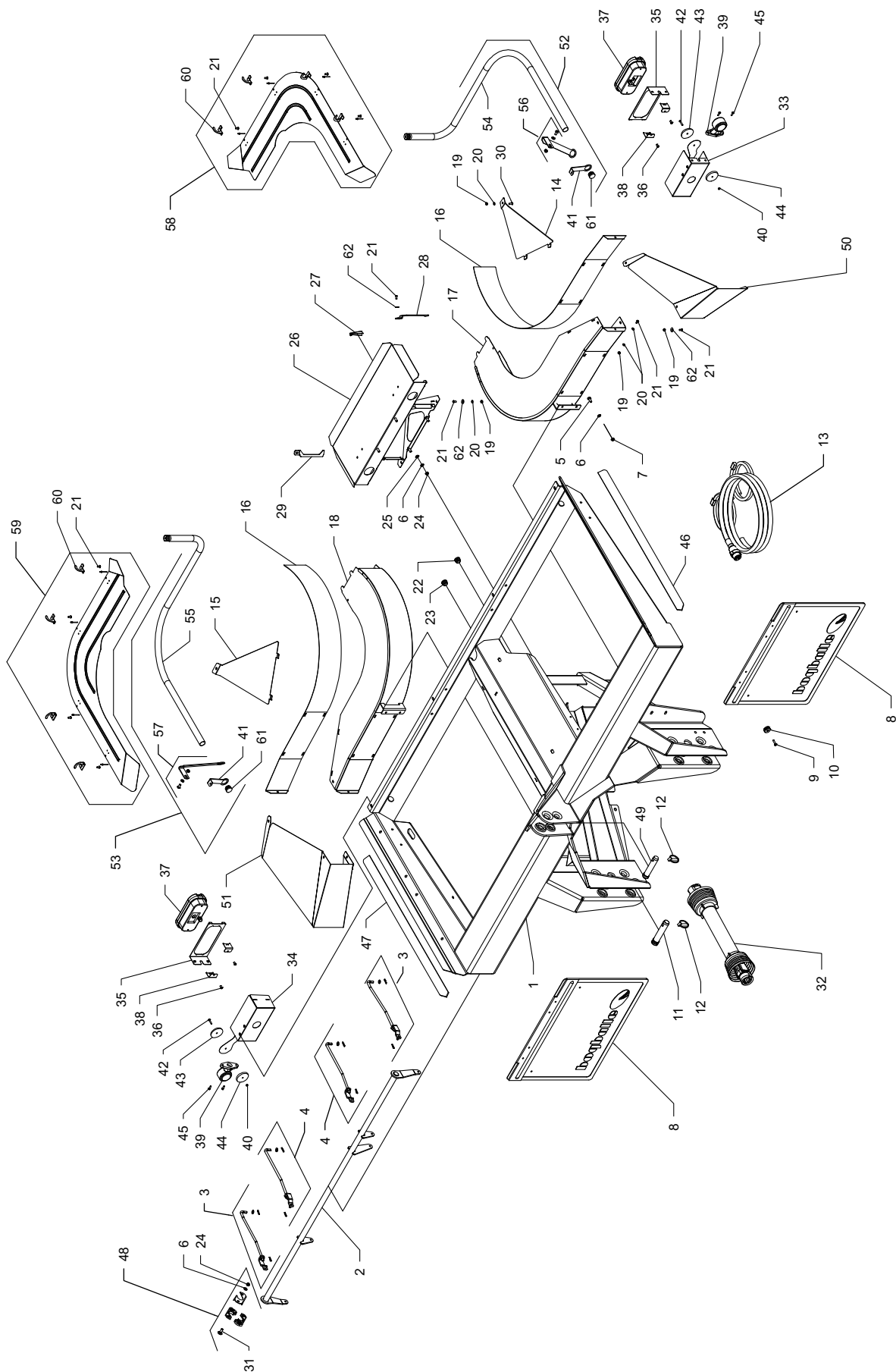

Pos. No.	Order no.	Notes.	Pos. No.	Order no.	Notes.
1	6320-01	M3	46	6310-13	Left
1	6320-20	M3W	47	6310-14	Right
2	6340-01		48	6340-05	
3	6341-05		49	6320-04	ø25
4	6341-06		50	6930-92	Left
5	9962-04	M8x20	51	6930-93	Right
6	9930-32	D8/16	52	6230-02	Left
7	9969-31	M8	53	6230-03	Right
8	4970-81		54	6230-05	Left
9	9961-14	M6x25	55	6230-06	Right
10	9990-43		56	6230-15	Left
11	6320-03	ø28	57	6230-16	Right
12	9938-74		58	6231-23	Left
13	6930-22		59	6231-24	Right
14	6371-15	Left	60	6231-30	
15	6371-16	Right	61	9990-12	
16	6371-10		62	9930-03	D6/18
17	6371-01	Left			
18	6371-02	Right			
19	9969-16	M6 Loc			
20	9930-02	D6/12			
21	9961-20	M6x12			
22	9990-08				
23	6350-12				
24	9969-32	M8 Loc			
25	9930-51	D8/17			
26	6372-01				
27	6372-15				
28	6372-10	Left			
29	6372-11	Right			
30	9961-27	M6x20			
31	9962-17	M8x25			
32	9985-40	810mm			
33	6930-38	Left			
34	6930-39	Right			
35	6930-41				
36	9961-29	M6x12			
37	6930-35				
38	6930-34				
39	9943-05				
40	9968-79	M5			
41	6230-08				
42	9929-15	M5x16			
43	9943-26	Red			
44	9943-27	White			
45	9929-19	M5x25			

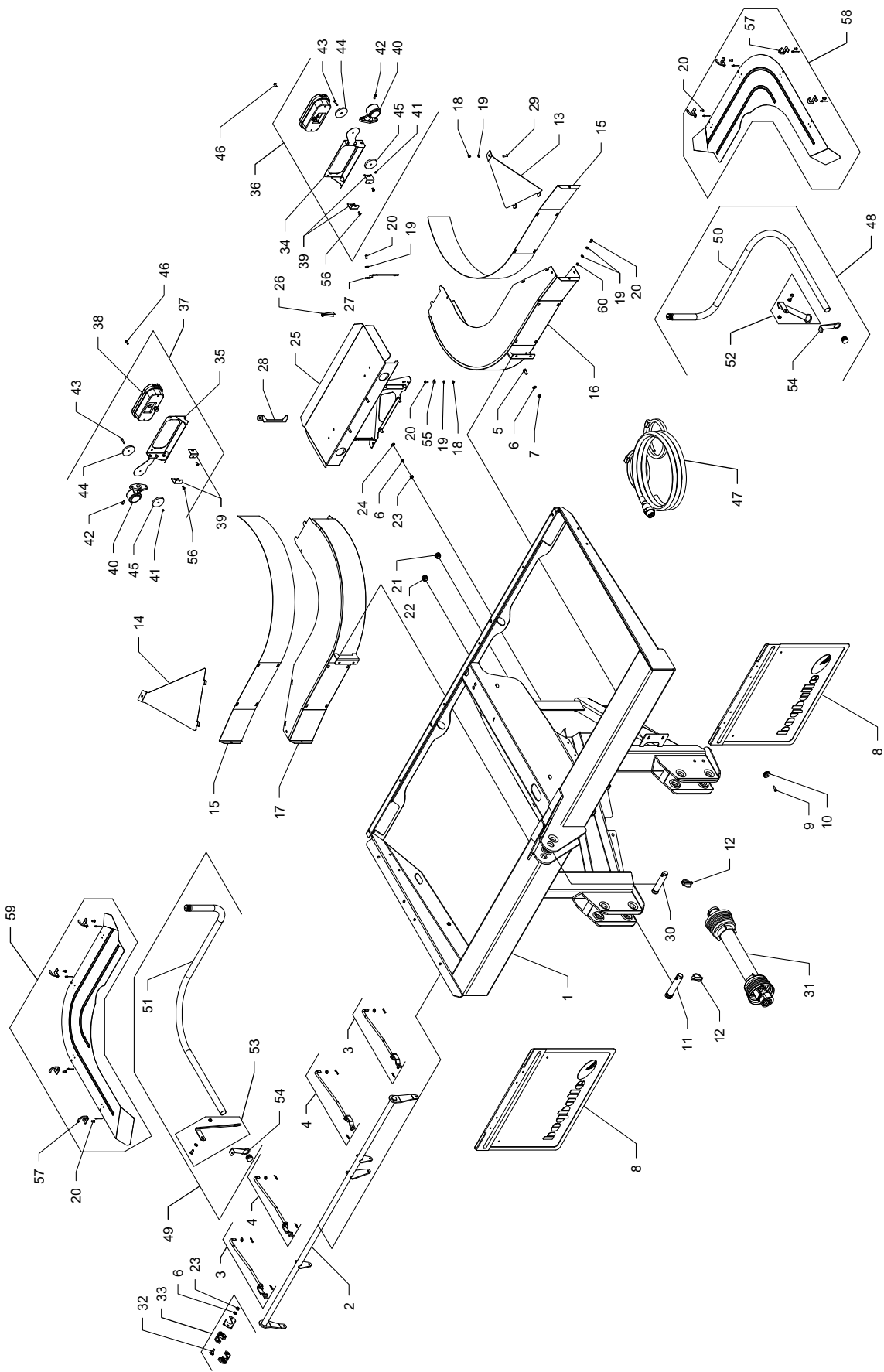

Pos. No.	Order no.	Notes.	Pos. No.	Order no.	Notes.
1	6220-02	M2	46	9961-21	M6x16
1	6220-21	M2W	47	6930-22	
2	6340-01		48	6230-02	Left
3	6341-05		49	6230-03	Right
4	6341-06		50	6230-05	Left
5	9962-04	M8x20	51	6230-06	Right
6	9930-32	D8/16	52	6230-15	Left
7	9969-31	M8	53	6230-16	Right
8	4970-81		54	6230-08	
9	9961-14	M6x25	55	9930-03	D6/18
10	9990-43		56	9961-29	M6x12
11	6320-03	ø28	57	6231-30	
12	9938-74		58	6231-23	Left
13	6371-15	Left	59	6231-24	Right
14	6371-16	Right	60	9969-18	M6
15	6371-10				
16	6371-01	Left			
17	6371-02	Right			
18	9969-16	M6 Loc			
19	9930-02	D6/12			
20	9961-20	M6x12			
21	9990-08				
22	6350-12				
23	9969-32	M8 Loc			
24	9930-51	D8/16			
25	6372-01				
26	6372-15				
27	6372-10	Left			
28	6372-11	Right			
29	9961-27	M6x20			
30	6320-04	ø25			
31	9985-40	810mm			
32	9962-17	M8x25			
33	6340-05				
34	6920-49	Left			
35	6920-50	Right			
36	6920-47	Left			
37	6920-48	Right			
38	6930-35				
39	6930-34				
40	9943-05				
41	9968-79	M5			
42	9929-19	M5x25			
43	9929-15	M5x16			
44	9943-26	Red			
45	9943-27	White			

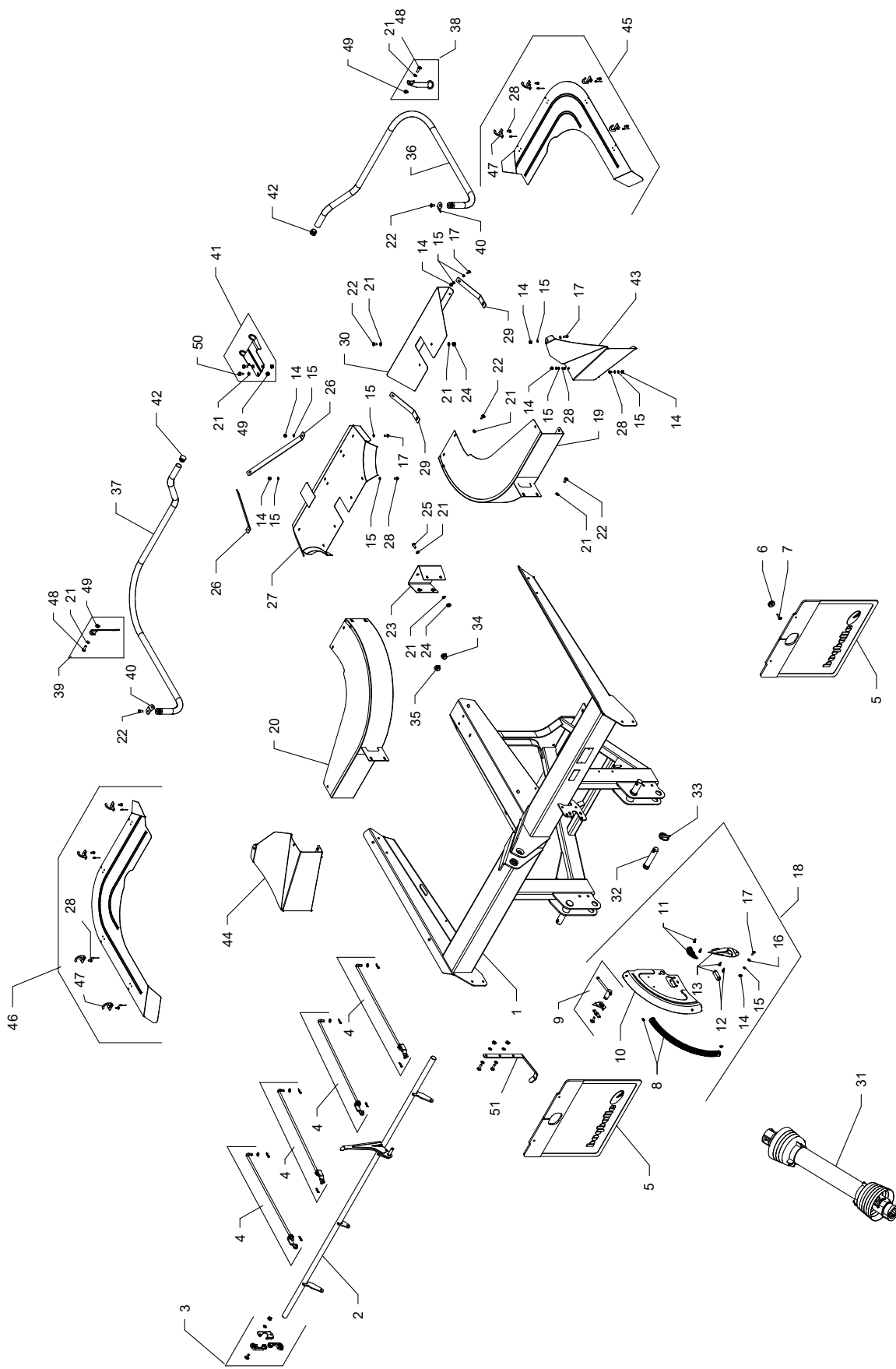

Pos. No.	Order no.	Notes.	Pos. No.	Order no.	Notes.
1	6820-01	L2	46	6231-24	Right
1	6820-20	L2W	47	6231-30	
2	6840-01		48	9913-50	M8x20
3	6340-05		49	9969-32	M8 Loc
4	6841-05		50	9962-04	M8x20
5	6875-01		51	6830-21	
6	9990-43				
7	9961-14	M6x25			
8	6840-25				
9	6381-13				
10	6840-21				
11	6381-18				
12	6381-17				
13	6381-16				
14	9969-16	M6 Loc			
15	9930-02	D6/12			
16	9930-53	D8/15/3			
17	9961-21	M6x16			
18	6840-20				
19	6871-01	Left			
20	6871-02	Right			
21	9930-32	D8/16			
22	9962-26	M8x16			
23	6871-10				
24	9969-31	M8			
25	9913-50	M8x20			
26	6874-03				
27	4474-02				
28	9961-20	M6x12			
29	4473-02				
30	4473-01				
31	9985-27	Lgt. 710 mm			
32	6320-04				
33	9938-74				
34	9990-08				
35	6350-12				
36	6830-05	Left			
37	6830-06	Right			
38	6830-15	Left			
39	6830-16	Right			
40	6830-12				
41	6830-18				
42	9990-12				
43	6980-72	L2W			
44	6980-73	L2W			
45	6231-23	Left			

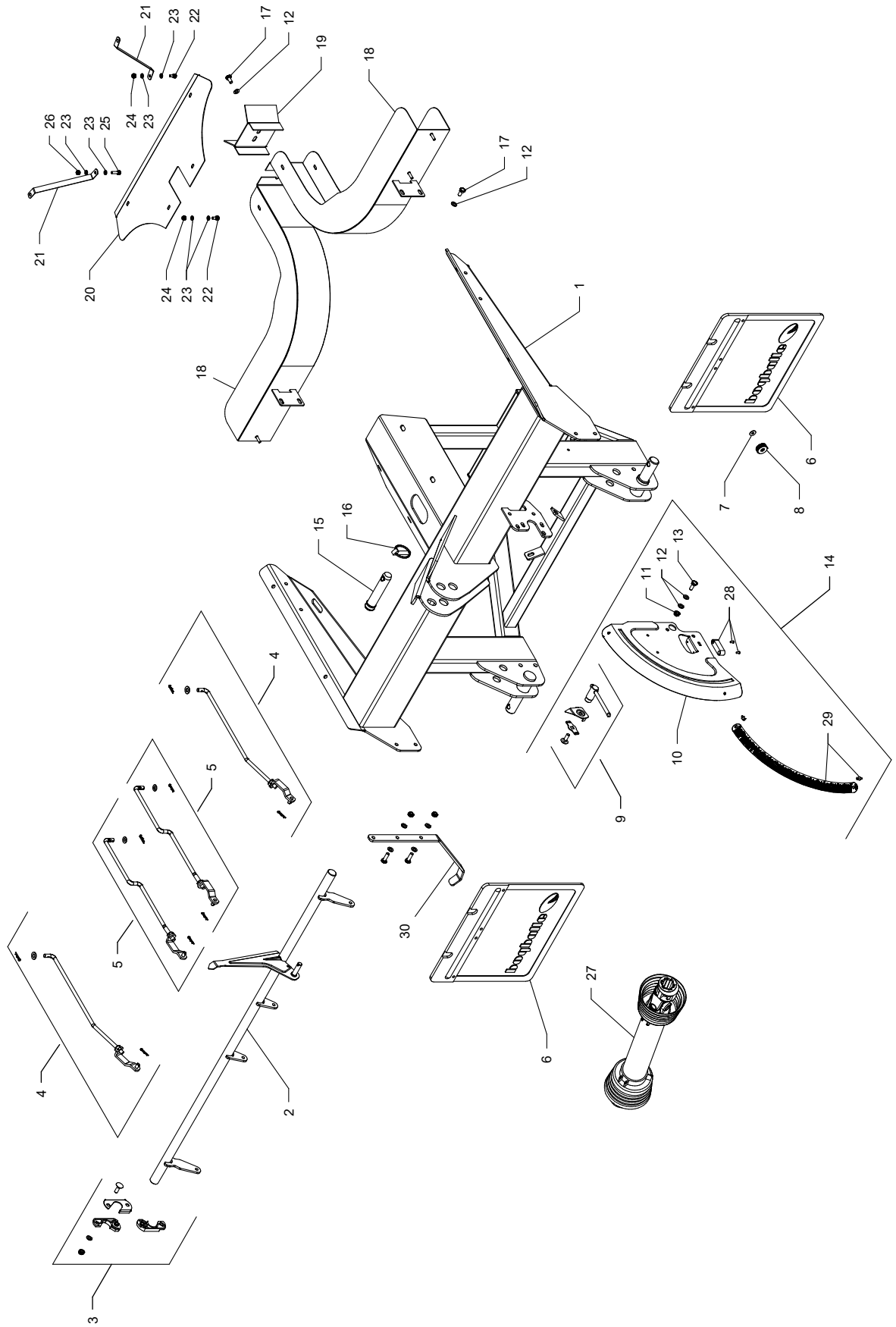

Pos. No.	Order no.	Notes.	Pos. No.	Order no.	Notes.
1	6720-01				
2	6740-01				
3	6340-05				
4	6741-05				
5	6741-06				
6	6910-81				
7	9930-03	D6/18			
8	9990-43				
9	6381-13				
10	6840-21				
11	9969-32	M8			
12	9930-32	D8/16			
13	9962-04	M8/20			
14	6740-20				
15	6320-04				
16	9938-74				
17	9962-03	M8x16			
18	6771-01				
19	6171-09				
20	6174-01				
21	6174-02				
22	9961-11	M6x12			
23	9930-02	D6/12			
24	9969-16	M6 locknut			
25	9961-12	M6x20			
26	9969-15	M6 nut			
27	9985-24	Lgt. 560 mm			
28	6381-17				
29	6840-25				
30	6830-21				

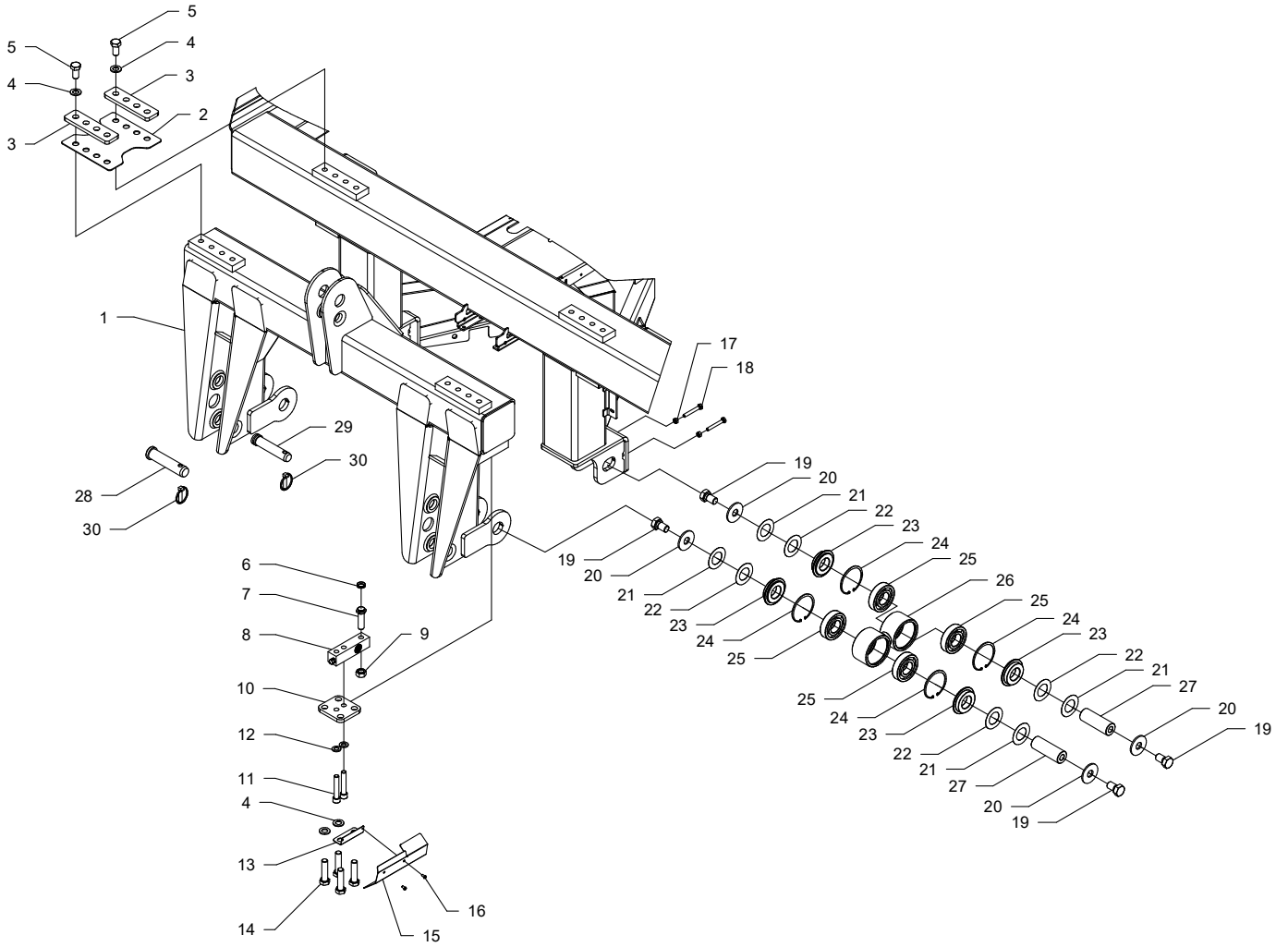

Pos. No.	Order no.	Notes.	Pos. No.	Order no.	Notes.
1	6422-30				
2	6420-25				
3	6420-26				
4	9930-40	D21/37			
5	9965-00	M20x40			
6	9936-27				
7	6320-29				
8	9942-33				
9	9968-97	M20			
10	6422-43				
11	9913-41	M16x90 KV12.9			
12	9930-20	D17/30			
13	6422-44				
14	9967-52	M20x80			
15	6322-46	Left			
15	6322-47	Right			
16	9961-20	M6x12			
17	9969-46	M10			
18	9963-19	M10x75			
19	9967-61	M24x40			
20	6420-37	D26/72			
21	6420-35	0,5 mm			
22	6420-36	1 mm			
23	6420-34				
24	9937-50	I 100			
25	9950-06	6309-2RS			
26	6420-30				
27	6420-33				
28	6420-04	Cat 3			
29	6420-03	Cat 3			
30	9938-75				

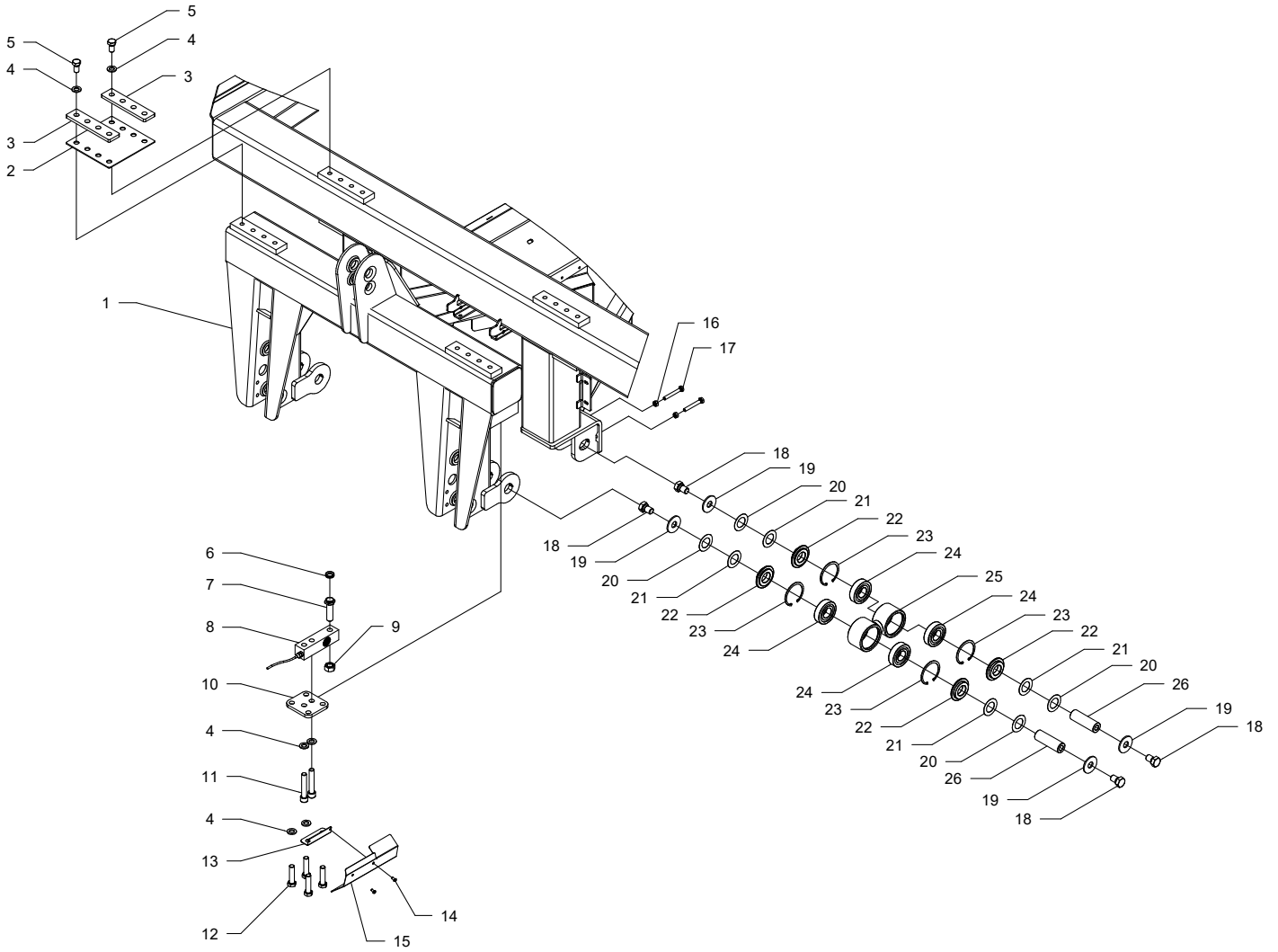

Pos. No.	Order no.	Notes.	Pos. No.	Order no.	Notes.
1	6322-30				
2	6320-25				
3	6320-26				
4	9930-20	D17/30			
5	9964-71	M16x30			
6	9936-27				
7	6320-29				
8	9942-33				
9	9968-97	M20			
10	6322-43				
11	9913-41	M16x90 KV12.9			
12	9964-77	M16x65			
13	6322-45				
14	9961-20	M6x12			
15	6322-46	Left			
15	6322-47	Right			
16	9969-46	M10			
17	9963-19	M10x75			
18	9964-98	M20x30			
19	9930-15	D22/59			
20	6320-34	0,5 mm			
21	6320-35	1 mm			
22	6320-33				
23	9937-48	I 80			
24	9950-07	6307-2RS			
25	6320-30				
26	6320-32				

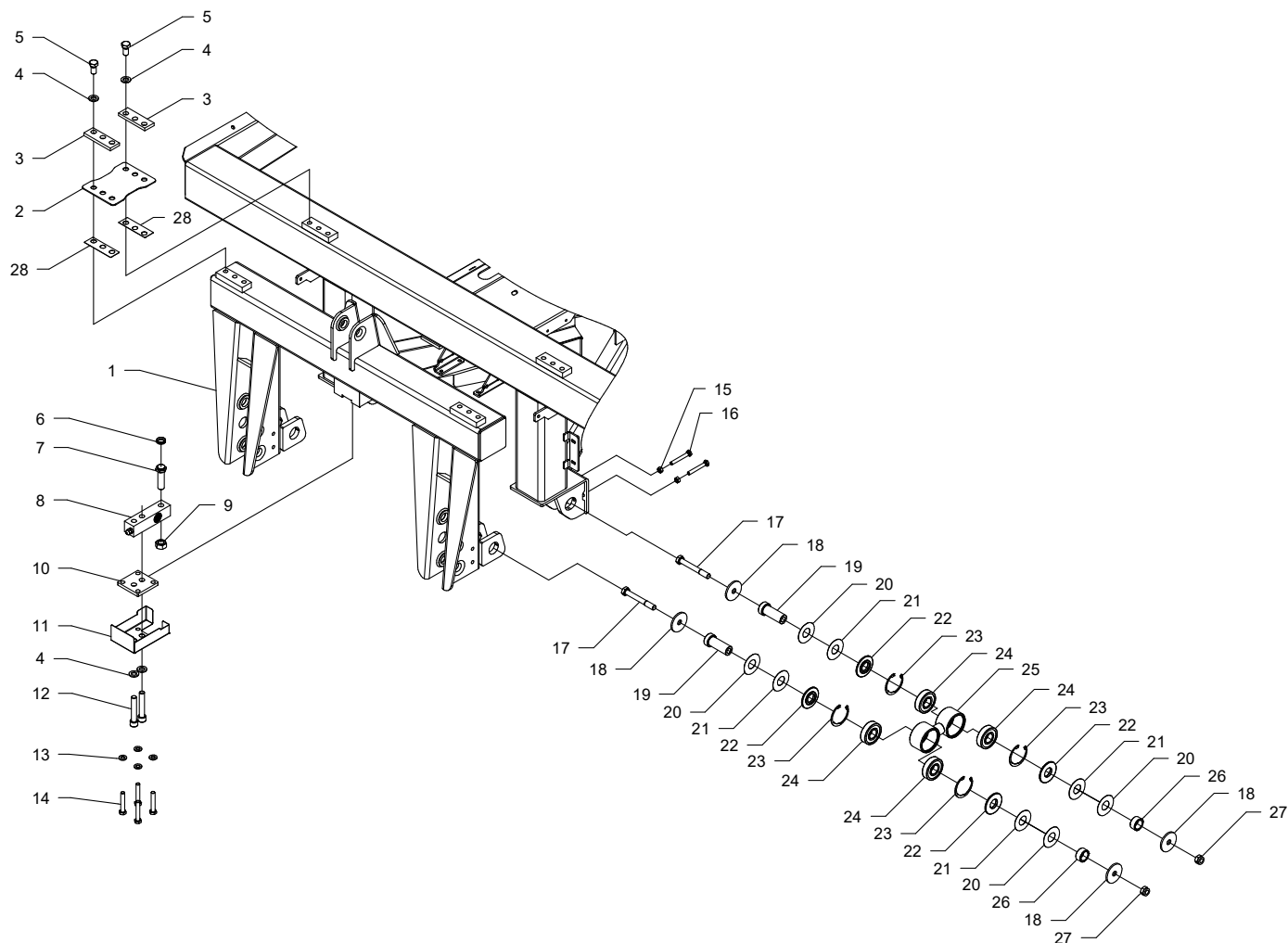

Pos. No.	Order no.	Notes.	Pos. No.	Order no.	Notes.
1	6222-30				
2	6220-25				
3	6220-26				
4	9930-20	D17/30			
5	9964-71	M16x30			
6	9936-27				
7	6320-29				
8	9942-33				
9	9968-97	M20			
10	4522-42				
11	4522-40				
12	9913-41	M16x90 KV12.9			
13	9930-35	D12/24			
14	9965-07	M12x70			
15	9969-46	M10			
16	9963-18	M10x75			
17	9964-79	M16x120			
18	6220-34				
19	6220-35				
20	6220-38	0,5 mm			
21	6220-37	1 mm			
22	6220-33				
23	9937-45	I 72			
24	9950-05	6306-2RS			
25	6220-30				
26	6220-36				
27	9969-84	M16			
28	6220-27				

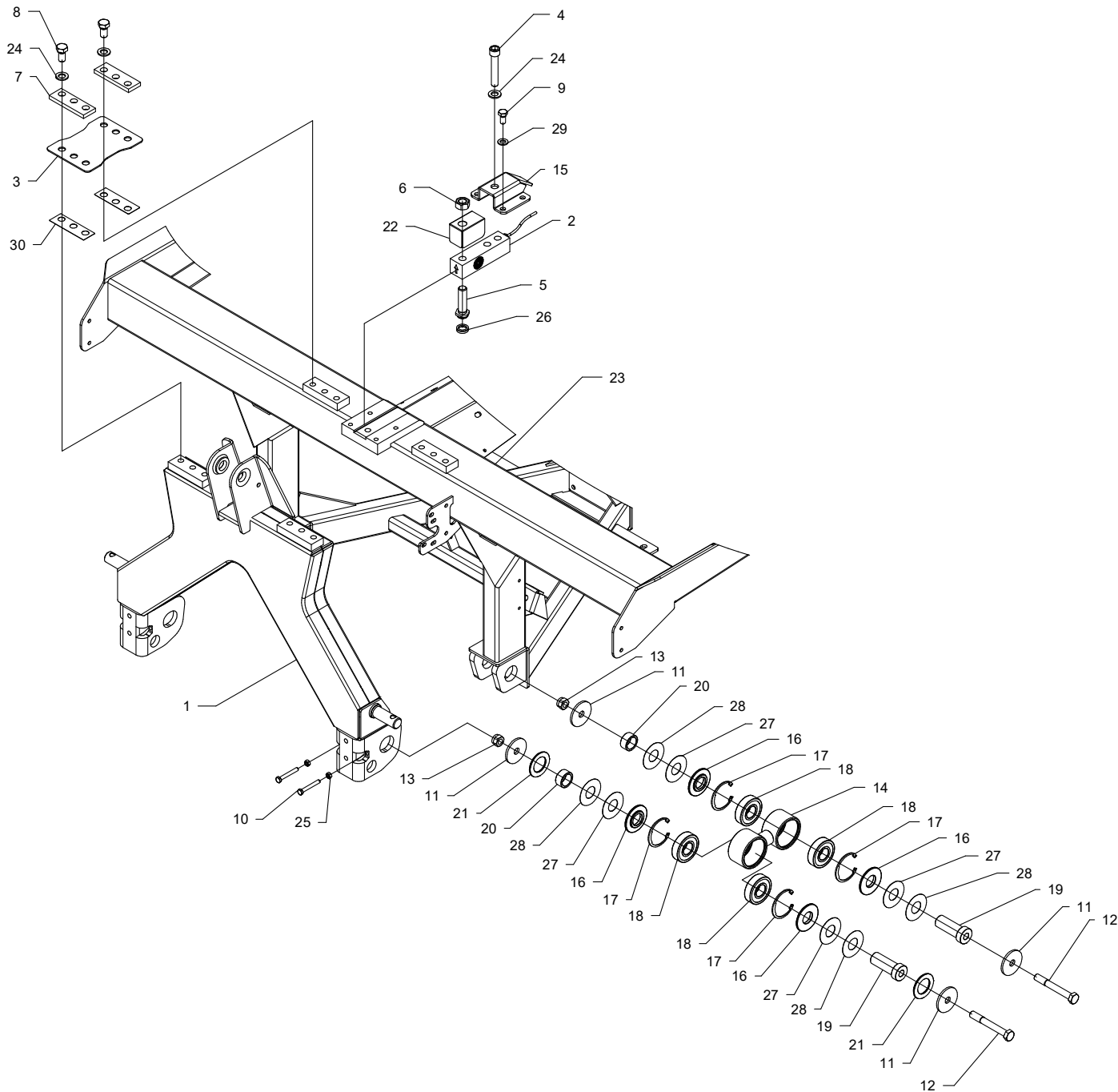

Pos. No.	Order no.	Notes.	Pos. No.	Order no.	Notes.
1	6822-30				
2	9942-33				
3	6220-25				
4	9913-41				
5	6320-29				
6	9968-97	M20			
7	6220-26				
8	9964-71	M16x30			
9	9964-43	M12x25			
10	9962-22	M8x60			
11	6220-34				
12	9964-79	M16x120			
13	9969-84	M16			
14	6220-30				
15	6822-45				
16	6220-33				
17	9937-45				
18	9950-05				
19	6220-35				
20	6220-36				
21	6820-30				
22	6822-46				
23	6820-20				
24	9930-20	D17/30			
25	9969-31	M8			
26	9936-27				
27	6220-37				
28	6220-38				
29	9930-35	D13/24			
30	6220-27				

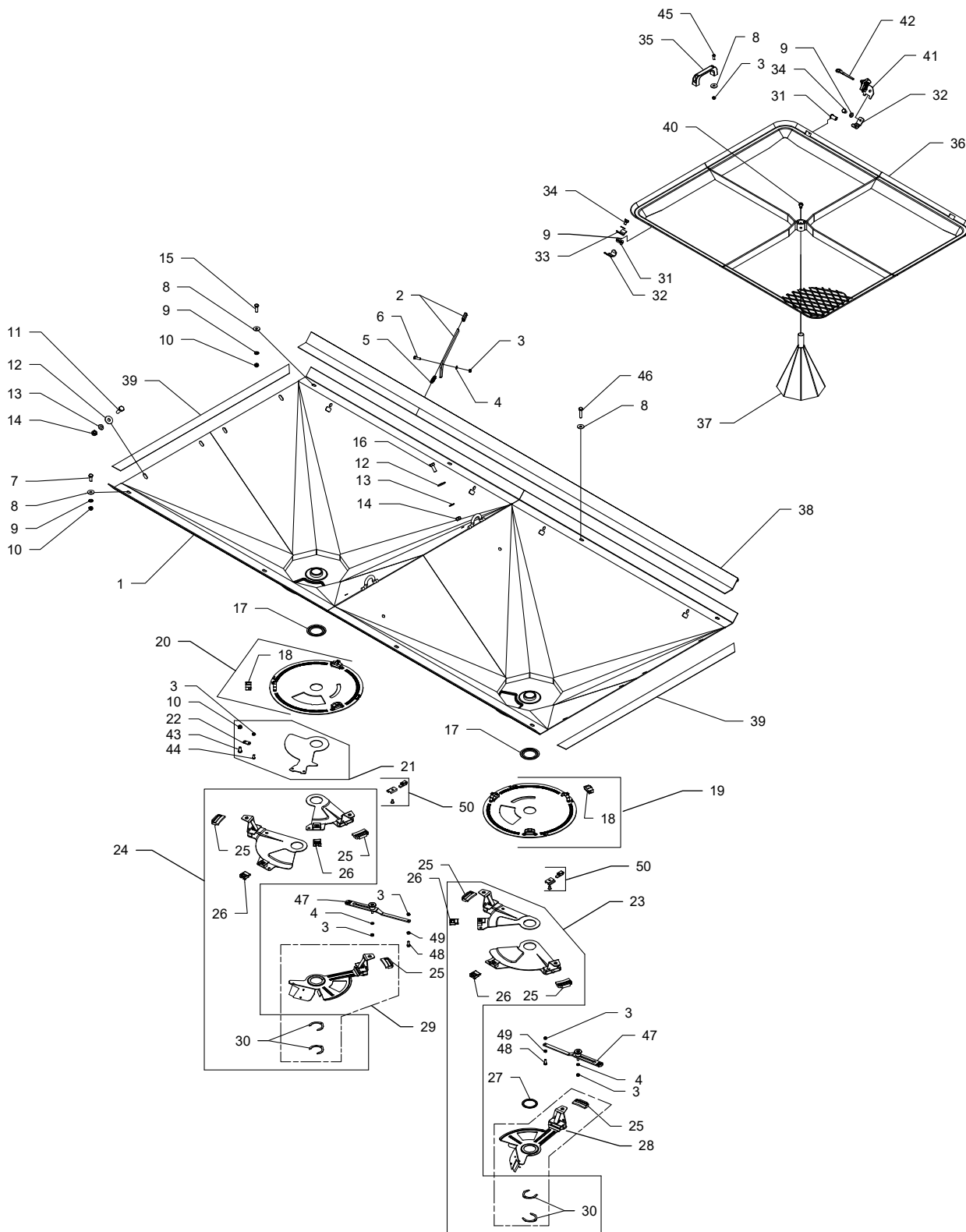

Pos. No.	Order no.	Notes.	Pos. No.	Order no.	Notes.
1	6310-05		47	6312-31	
2	4510-09		48	9961-04	M6x16
3	9969-16	M6	49	9969-15	M6
4	9930-02	D6/12	50	6312-30	
5	9934-13	Ø1,5x11x32			
6	9961-12	M6x20			
7	9962-04	M8x20			
8	9930-31	D8/24			
9	9930-32	D8/24			
10	9969-32	M8			
11	9963-12	M10x30			
12	9930-25	D10x30			
13	9968-44	D10/21			
14	9969-45	M10			
15	9962-05	M8x25			
16	9963-01	M10x25			
17	4512-12				
18	4512-11				
19	4512-13	Left			
20	4512-14	Right			
21	6212-02				
22	6312-17				
23	6312-03	Left			
24	6312-04	Right			
25	4412-20	Big			
26	4412-21	Small			
27	4012-11				
28	6312-19	Left			
29	6312-20	Right			
30	4511-06				
31	6313-10				
32	6313-11				
33	6313-12				
34	9962-19	M8x12			
35	9990-38				
36	6313-02				
37	4016-05				
38	6310-03				
39	6210-13	M2(W)			
40	9962-03	M8x16			
41	6313-30				
42	6313-27				
43	9962-26	M8x16 BH			
44	9961-20	M6x12			
45	9961-21	M6x16 BH			
46	9962-21	M8x35			

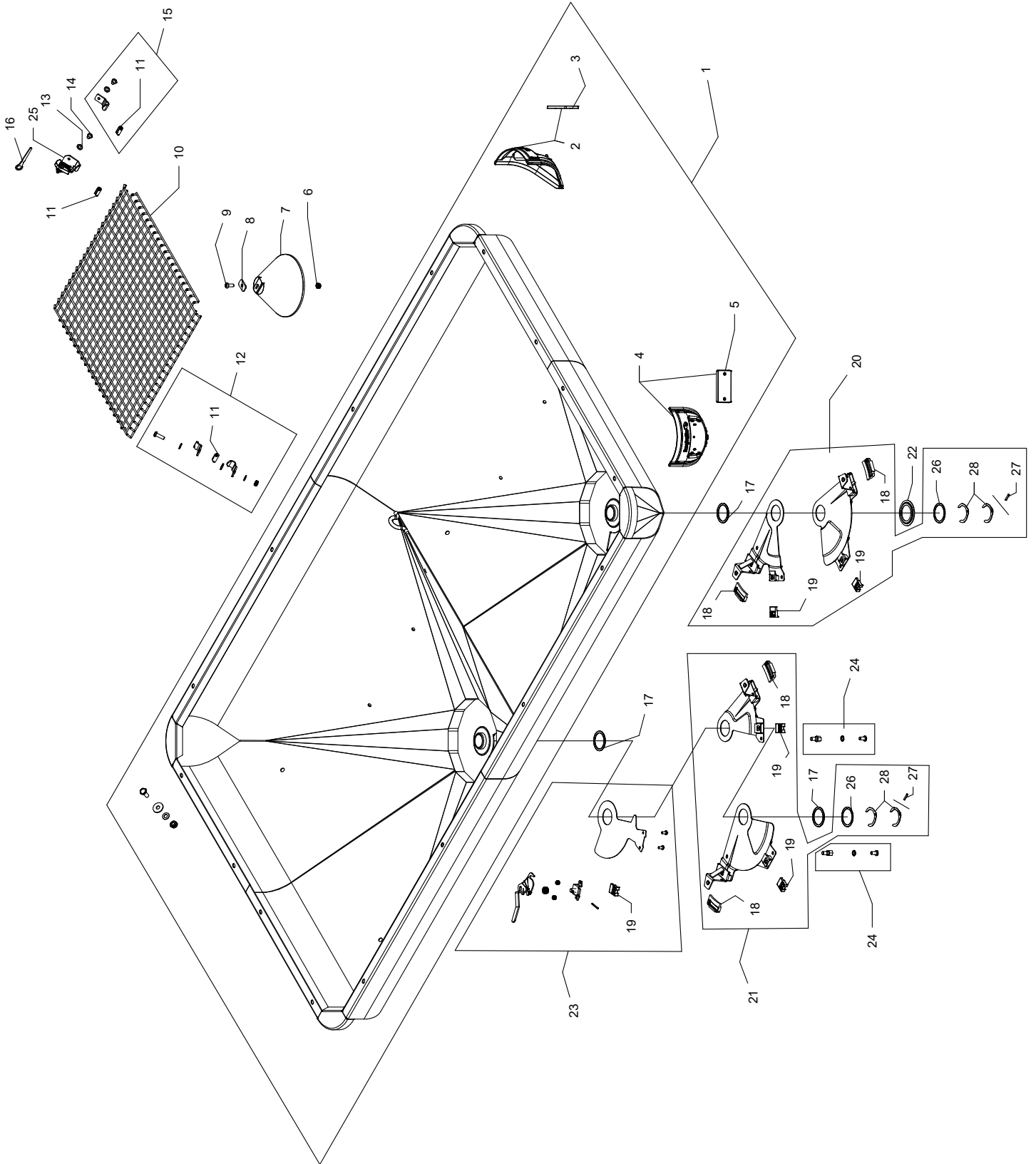

Pos. No.	Order no.	Notes.	Pos. No.	Order no.	Notes.
1	6810-04				
2	6311-30				
3	9943-32	Red			
4	6311-31				
5	9943-33	White			
6	9969-32	M8			
7	6716-01				
8	6716-05				
9	9913-50	M8x20			
10	6713-02				
11	6713-10				
12	6713-13				
13	9930-32	D8/16			
14	9962-18	M8x10			
15	6713-12				
16	6313-27				
17	4012-11				
18	4412-20	Big			
19	4412-21	Small			
20	6312-03	Left			
21	6312-04	Right			
22	4512-12				
23	6812-01				
24	6312-13				
25	6813-30				
26	6312-11	0,8			
27	9933-25	Ø2x10			
28	4511-06				

Hopper with outlet shutters

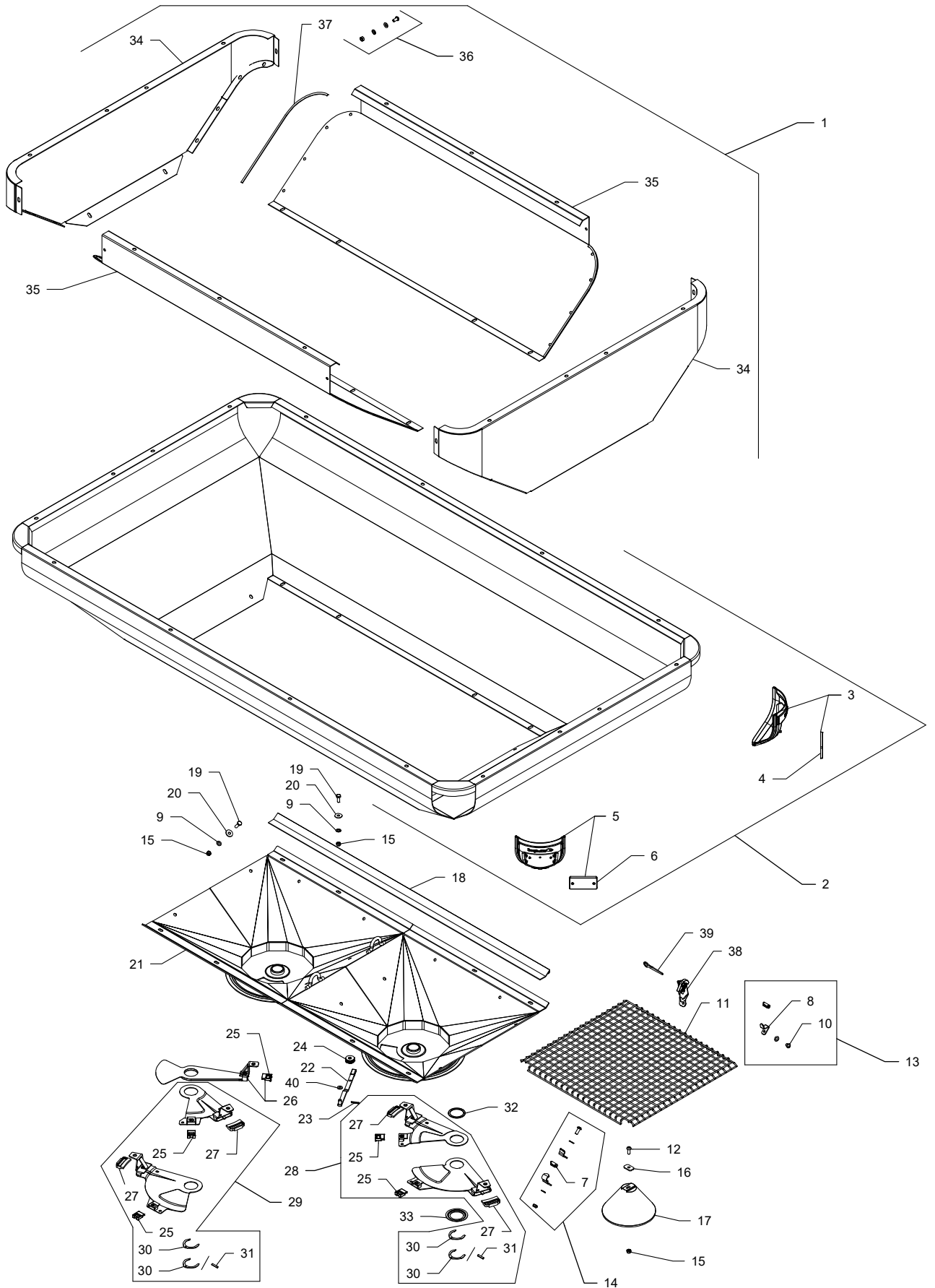

Pos. No.	Order no.	Notes.	Pos. No.	Order no.	Notes.
1	6711-02	120x125			
2	6711-21	120x210			
3	6311-30				
4	9943-32	Red			
5	6311-31				
6	9943-33	White			
7	6713-10				
8	6713-11				
9	9930-32	D8/16			
10	9962-18	M8x10			
11	6713-02				
12	9913-50	M8x20			
13	6713-12				
14	6713-13				
15	9969-32	M8 locknut			
16	6716-05				
17	6716-01				
18	6710-03				
19	9962-04	M8x20			
20	9930-31	D8/25			
21	6710-05				
22	6112-01				
23	9934-01				
24	9990-43				
25	4412-21	Small			
26	4611-00				
27	4412-20	Big			
28	6312-03	Left			
29	6312-04	Right			
30	4511-06				
31	9933-25	ø2x10			
32	4012-11				
33	4512-12				
34	6711-38				
35	6711-41				
36	6711-03				
37	6711-42				
38	6713-30				
39	6313-27				
40	9930-51	PA D8/17			

Hopper with outlet shutters

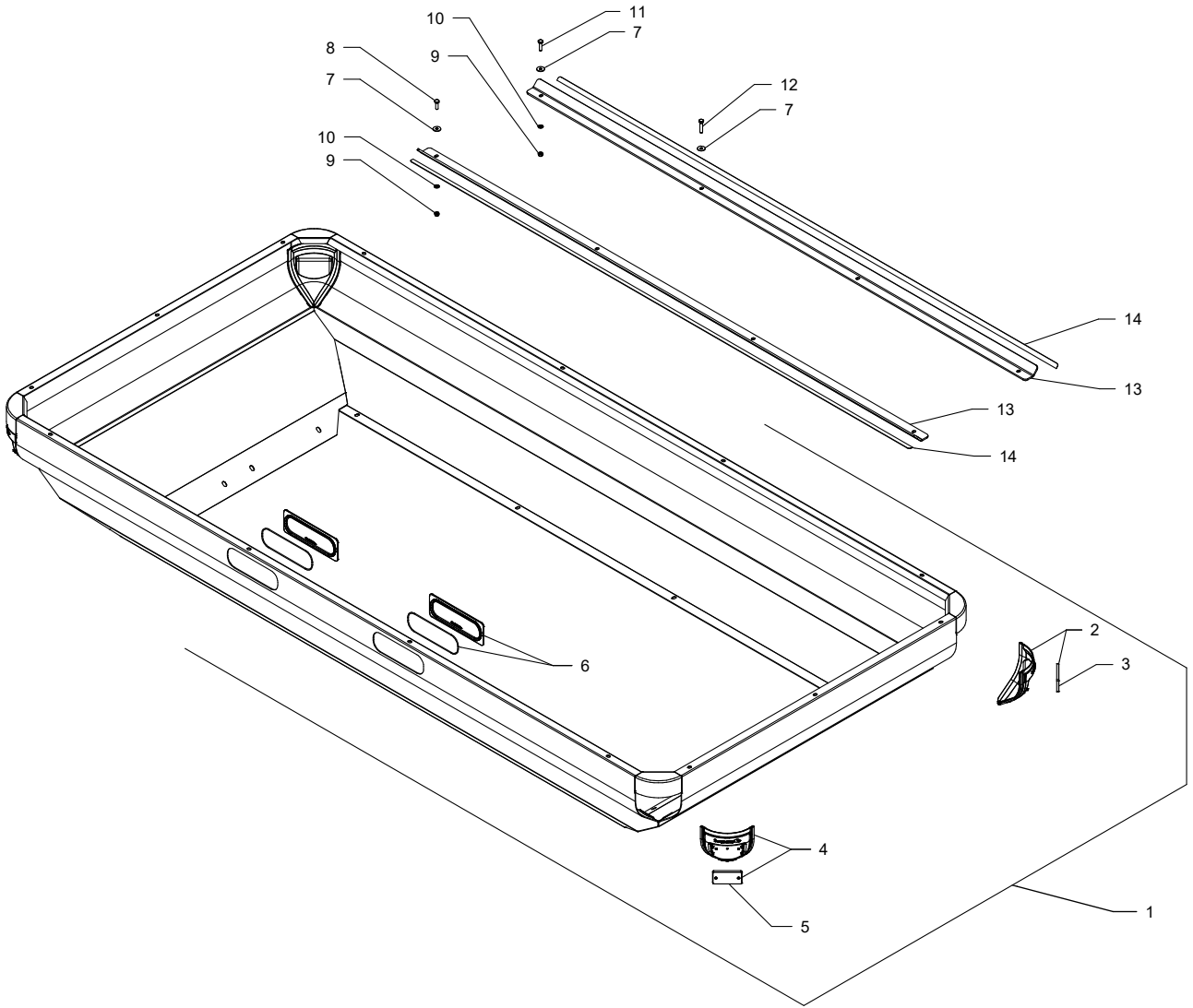

Pos. No.	Order no.	Notes.	Pos. No.	Order no.	Notes.
1	6311-16	Plus 1400x2900			
2	6311-30				
3	9943-32	Red			
4	6311-31				
5	9943-33	White			
6	6311-32				
7	9930-31	D8/24			
8	9962-05	M8x25			
9	9969-32	M8 Lock			
10	9930-32	D8/17			
11	9962-15	M8x30			
12	9962-16	M8 Lock			
13	6411-01	M6W			
14	6411-02				

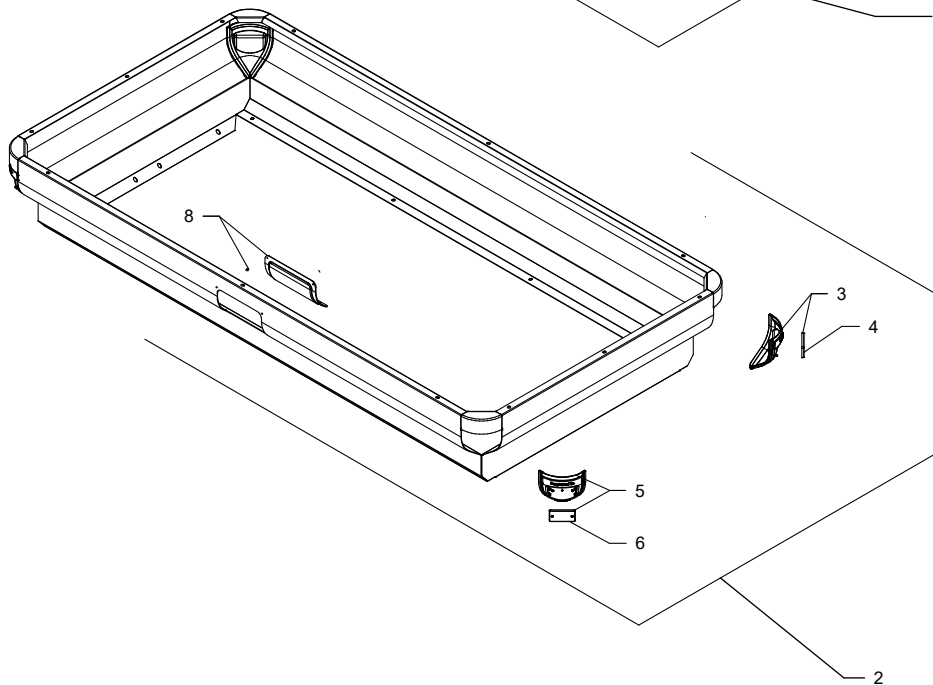
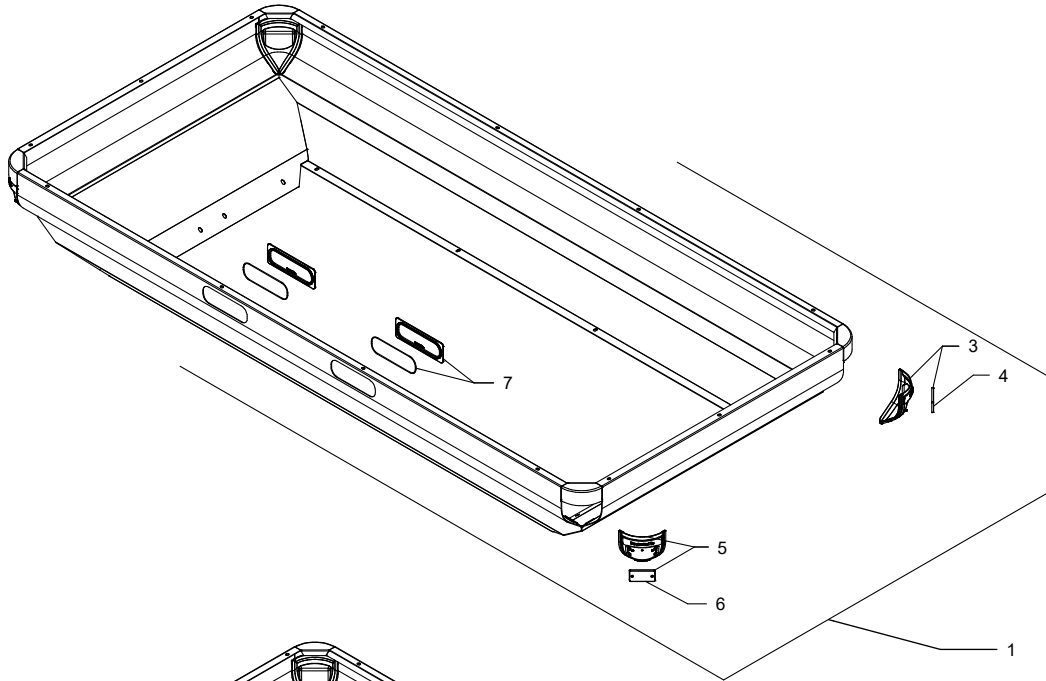

Pos. No.	Order no.	Notes.	Pos. No.	Order no.	Notes.
1	6311-16	M3(W) 1400x2900			
1	6211-21	M2(W) 1400x2900			
2	6211-25	M2(W) 1250x2400			
3	6311-30				
4	9943-32	Red			
5	6311-31				
6	9943-33	White			
7	6311-32				
8	6211-17				

Hopper

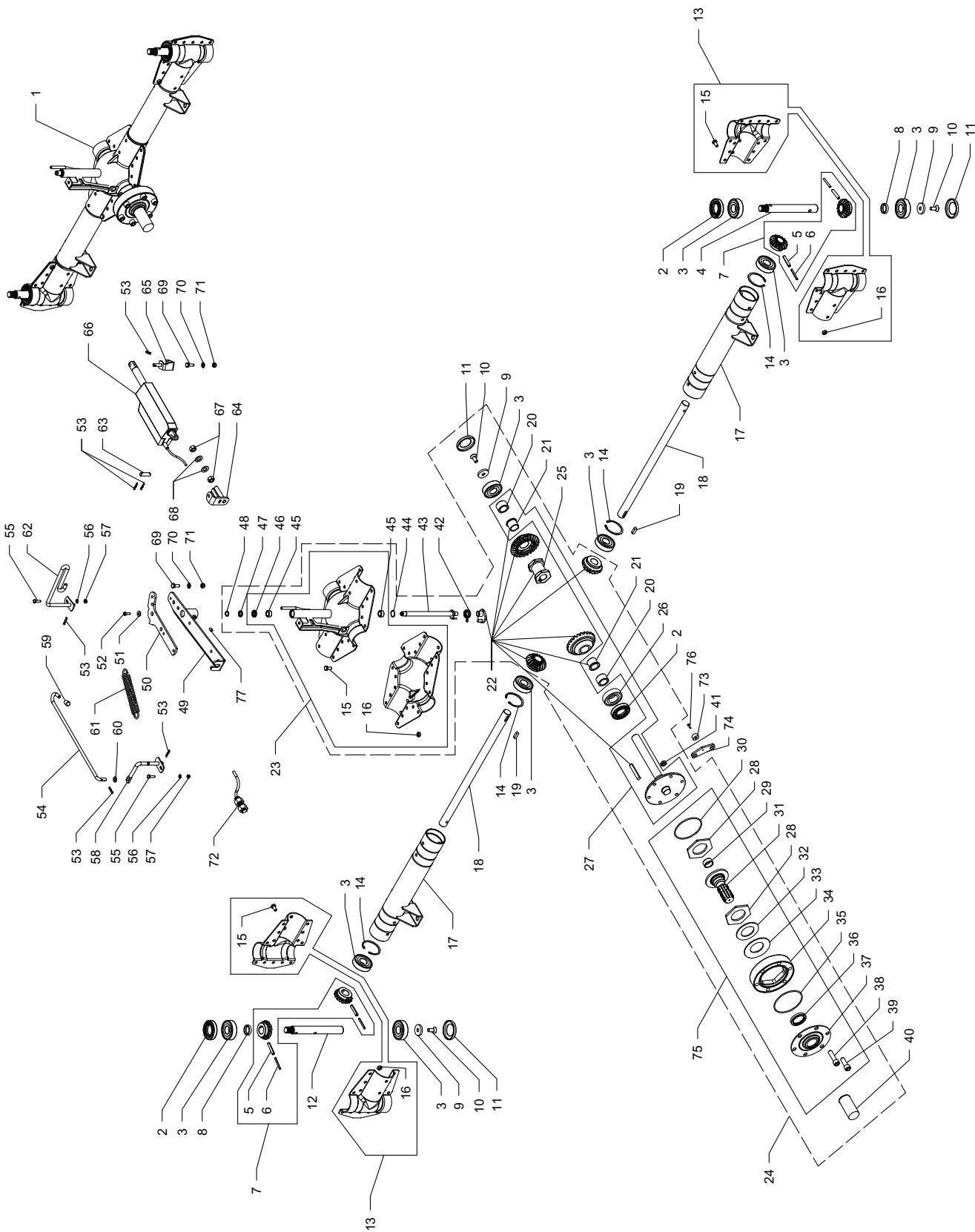

Pos. No.	Order no.	Notes.	Pos. No.	Order no.	Notes.
1	4750-02	540/750 rpm	47	9936-28	
2	9936-37	35x62x12/13	48	9937-13	U14
3	9950-02	6305-2RS	49	4655-05	
4	4155-04	Right thread	50	4653-15	
5	9933-12	Ø8x45	51	9930-07	D6/17
6	9933-17	Ø5x45	52	9961-24	M6x16
7	3265-02	15 teeth	53	9934-31	
8	3262-05		54	6350-11	
9	3260-04		55	9961-12	M6x20
10	9963-07	M10x25	56	9930-02	D6/12
11	3260-05		57	9969-16	M6
12	4062-05	Left thread	58	6350-08	
13	4454-05		59	9990-26	
14	9937-40	I60	60	9930-51	D8/17
15	9962-03	M8x16	61	9934-07	
16	9969-31	M8	62	4690-05	
17	4557-02		63	4790-36	
18	4156-02		64	4790-43	
19	9931-56	8x7x25	65	4790-47	
20	4652-03		66	9942-11	
21	4652-08		67	9969-60	M12
22	4652-11	17/24 teeth	68	9930-35	D12/24
23	4660-00		69	9962-04	M8x20
24	4750-50		70	9930-32	D8/16
25	4652-09		71	9969-32	M8
26	9950-03	6206-2RS	72	9941-34	
27	4652-01		73	9941-04	
28	3263-15		74	4790-38	
29	9990-90		75	3263-10	
30	9936-10	O-ring	76	9960-02	M4x16
31	3263-11		77	9913-19	M8x10
32	3263-12				
33	9931-10				
34	3263-20				
35	9936-09	O-ring			
36	9936-49				
37	3263-13				
38	9965-10	M12x45			
39	9965-09	M12x35			
40	9985-84				
41	9928-99	M12			
42	9934-02				
43	4653-02				
44	9931-15				
45	9990-99	14x20x10			
46	9936-29	14x22x4			

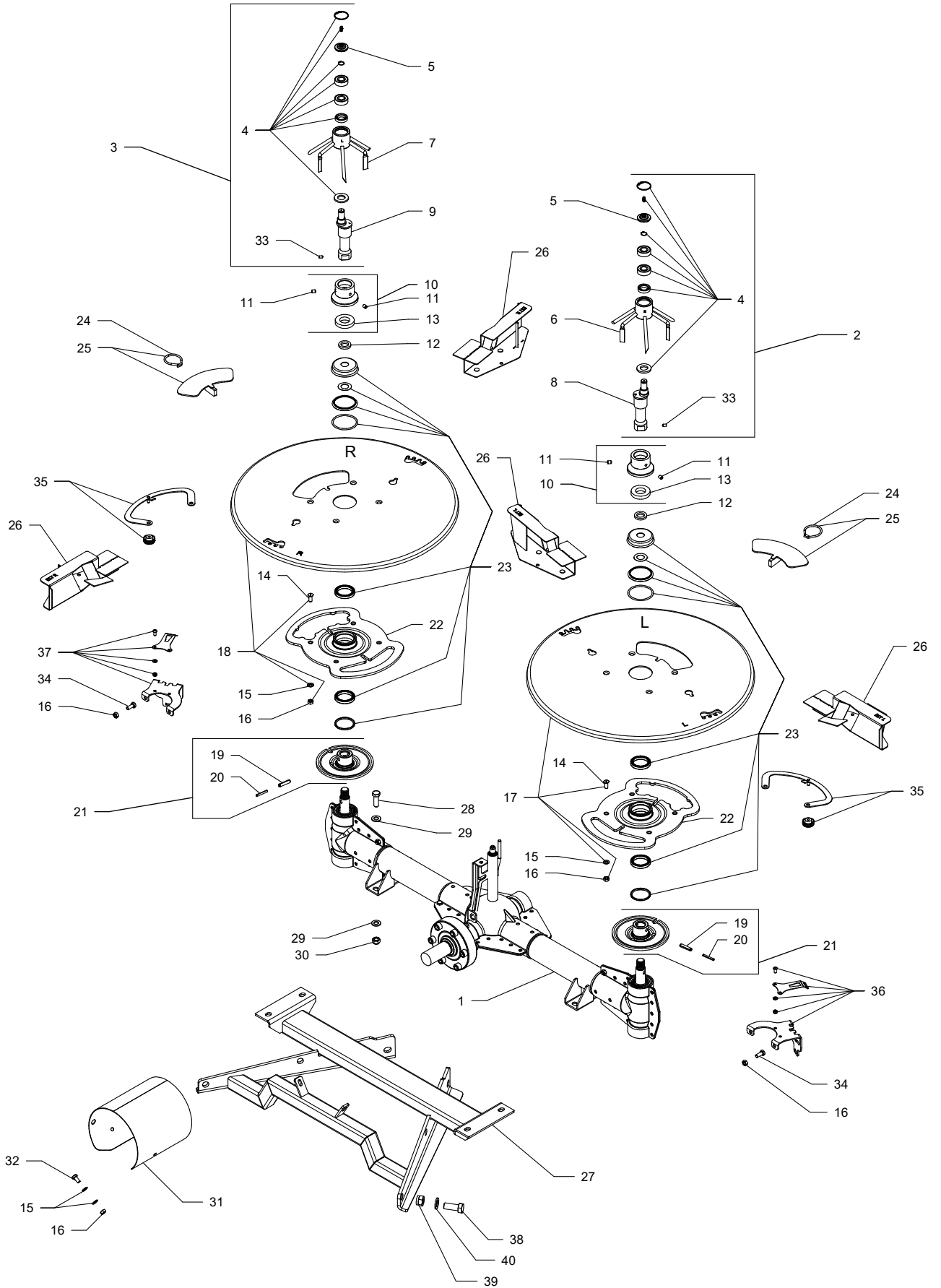

Pos. No.	Order no.	Notes.	Pos. No.	Order no.	Notes.
1	4750-02	540/750 rpm			
2	6260-01	L-side/R-thread			
3	6260-02	R-side/L-thread			
4	6260-10				
5	4056-03				
6	6262-05	L-side/R			
7	6262-06	R-side/L			
8	6261-02	L-side/R-thread			
9	6261-01	R-side/L-thread			
10	4158-05				
11	9913-19	M8x10			
12	4560-01	Ø20xØ30x5			
13	4158-10				
14	9929-35	M8x20			
15	9930-32	D8/16			
16	9969-31	M8			
17	6250-05	Left			
18	6250-06	Right			
19	9933-27	Ø8x36			
20	9933-26	Ø5x36			
21	6251-01				
22	6251-11				
23	6251-20				
24	6250-15				
25	6250-10				
26	4650-12	E1-T 2 Left/ 2 Right			
26	4650-20	E2-T 2 Left/ 2 Right			
26	4650-28	E6-T 2 Left/ 2 Right			
26	4650-36	E8-T 2 Left/ 2 Right			
27	6430-01				
28	9965-01	M12x35			
29	9930-35	D12/24			
30	9969-62	M12			
31	4470-01				
32	9962-03	M8x16			
33	9961-02	M6x10			
34	9962-04	M8x20			
35	6250-14				
36	6250-19	Left			
37	6250-20	Right			
38	9964-72	M16x40			
39	9969-84	M16			
40	9930-20	D17/30			

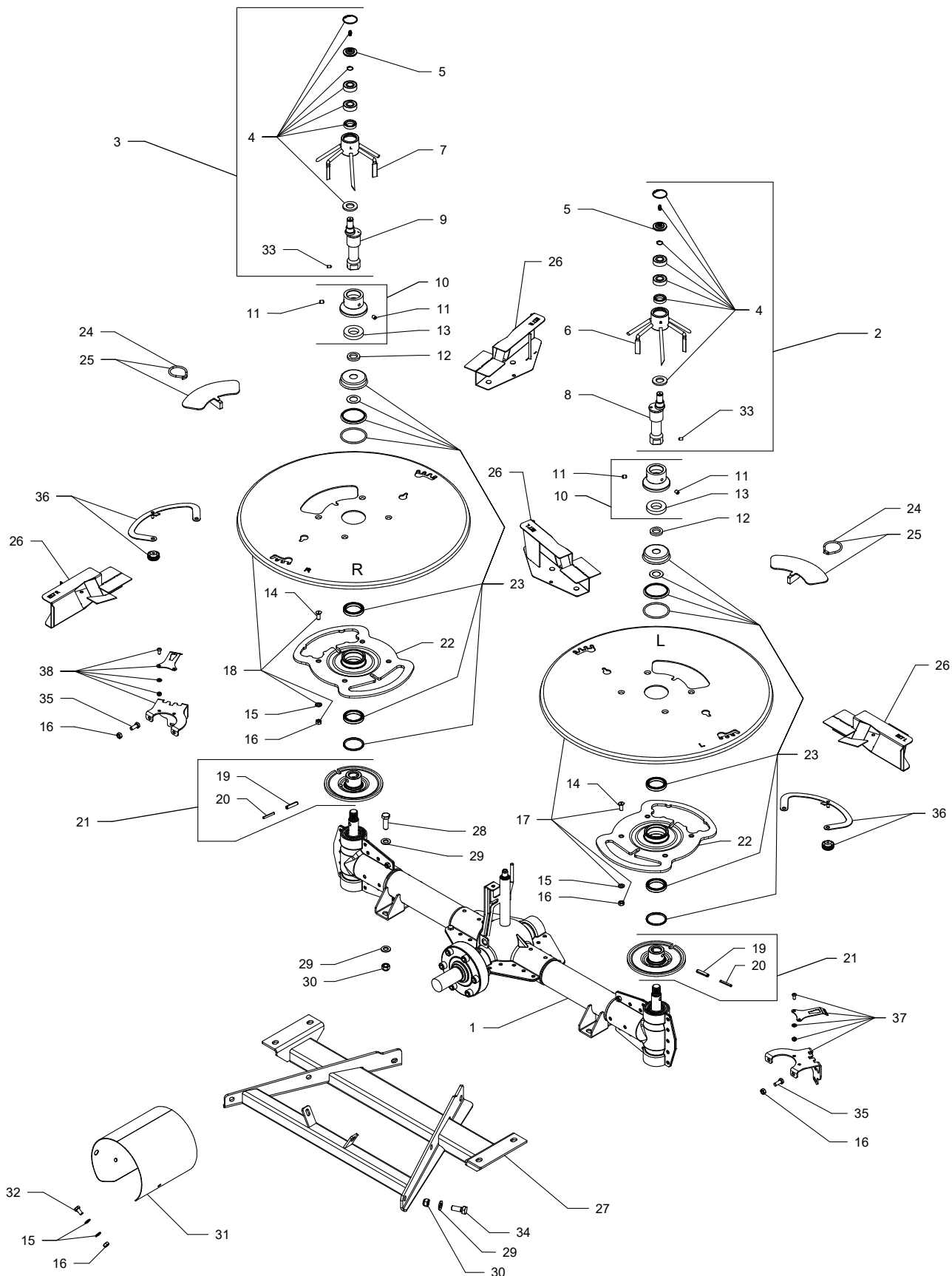

Pos. No.	Order no.	Notes.	Pos. No.	Order no.	Notes.
1	4750-02	540/750 rpm			
2	6260-01	L-side/R-thread			
3	6260-02	R-side/L-thread			
4	6260-10				
5	4056-03				
6	6262-05	L-side/R			
7	6262-06	R-side/L			
8	6261-02	L-side/R-thread			
9	6261-01	R-side/L-thread			
10	4158-05				
11	9913-19	M8x10			
12	4560-01	Ø20xØ30x5			
13	4158-10				
14	9929-35	M8x20			
15	9930-32	D8/16			
16	9969-31	M8			
17	6250-05	Left			
18	6250-06	Right			
19	9933-27	Ø8x36			
20	9933-26	Ø5x36			
21	6251-01				
22	6251-11				
23	6251-20				
24	6250-15				
25	6250-10				
26	4650-12	E1-T 2 Left/ 2 Right			
26	4650-20	E2-T 2 Left/ 2 Right			
26	4650-28	E6-T 2 Left/ 2 Right			
26	4650-36	E8-T 2 Left/ 2 Right			
27	6330-01				
28	9965-01	M12x35			
29	9930-35	D12/24			
30	9969-62	M12			
31	4470-01				
32	9962-03	M8x16			
33	9961-02	M6x10			
34	9965-03	M12x30			
35	9962-04	M8x20			
36	6250-14				
37	6250-19	Left			
38	6250-20	Right			

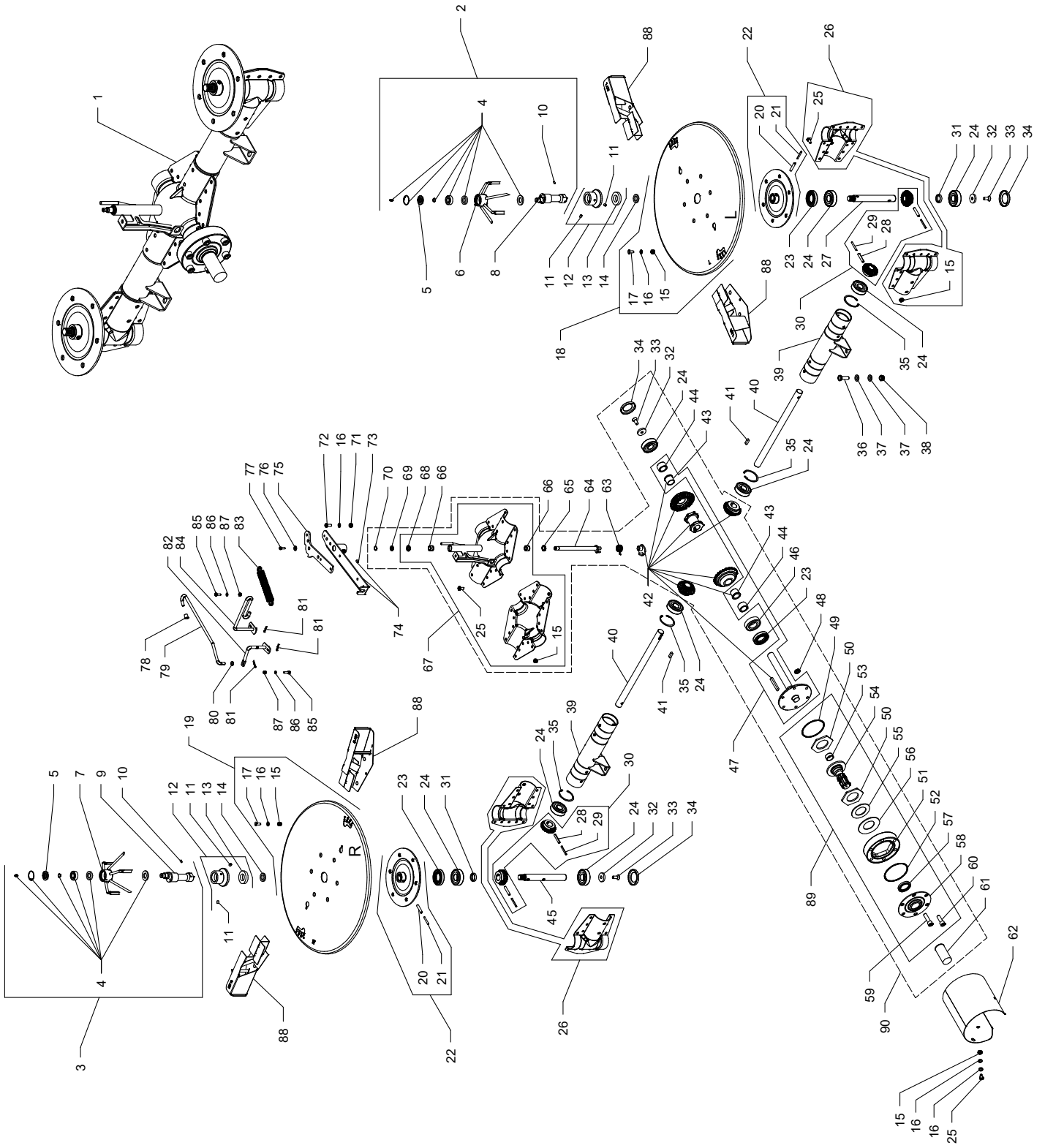

Pos. No.	Order no.	Notes.	Pos. No.	Order no.	Notes.
1	6850-02	540/750 rpm	48	9928-99	M12
2	4160-01	L-side/R-thread	49	9936-10	ø89,5xø3
3	4160-02	R-side/L-thread	50	3263-15	
4	4056-10		51	3263-20	
5	4056-03		52	9936-09	ø94xø3
6	4058-05	L-side/R	53	9990-90	
7	4058-06	R-side/L	54	3263-11	
8	4161-02	L-side/R-thread	55	3263-12	
9	4161-01	R-side/L-thread	56	9931-10	
10	9961-02	M6x10	57	9936-49	38x52x7
11	9913-19	M8x10	58	3263-13	
12	4158-05		59	9965-10	M12x45
13	4158-10		60	9965-09	M12x35
14	4560-01	ø20xø30x5	61	9985-84	
15	9969-31	M8	62	4470-01	
16	9930-32	D8/16	63	9934-02	
17	9929-35	M8x20	64	4653-02	
18	4550-05	Left	65	9931-15	
19	4550-06	Right	66	9990-99	14x20x10
20	9933-02	ø8x40	67	4660-00	
21	9933-11	ø5x40	68	9936-29	14x22x4
22	4051-05		69	9936-28	
23	9936-37	35x62x12/13	70	9937-13	U 14
24	9950-02	6305-2RS	71	9969-32	M8 Loc
25	9962-03	M8x16	72	9962-04	M8x20
26	4454-05		73	9913-19	M8x10
27	4155-04	Right thread	74	4655-05	
28	9933-12	ø8x45	75	4653-15	
29	9933-17	ø5x45	76	9930-07	D6/17/3
30	3265-02	15 teeth	77	9961-04	M6x16
31	3262-05		78	9990-26	
32	3260-04		79	6850-11	
33	9963-07	M10x25	80	9930-51	D8/16
34	3260-05		81	9934-31	
35	9937-40	I 60	82	6350-08	
36	9965-01	M12x35	83	9934-07	
37	9930-35	D12/24	84	4690-05	
38	9969-62	M12 Loc	85	9961-12	M6x20
39	4457-02		86	9930-02	D6/12
40	4456-02		87	9969-16	M6 Loc
41	9931-56	8x7x25	88	4650-12	E1-T 2 Left / 2 Right
42	4652-11	17/24 teeth	88	4650-20	E2-T 2 Left / 2 Right
43	4652-08		88	4650-28	E6-T 2 Left / 2 Right
44	4652-03		88	4650-50	U1-T 2 Left / 2 Right
45	4062-05	Left thread	89	3263-10	
46	9950-03	6206-2RS	90	4750-50	
47	4652-01				

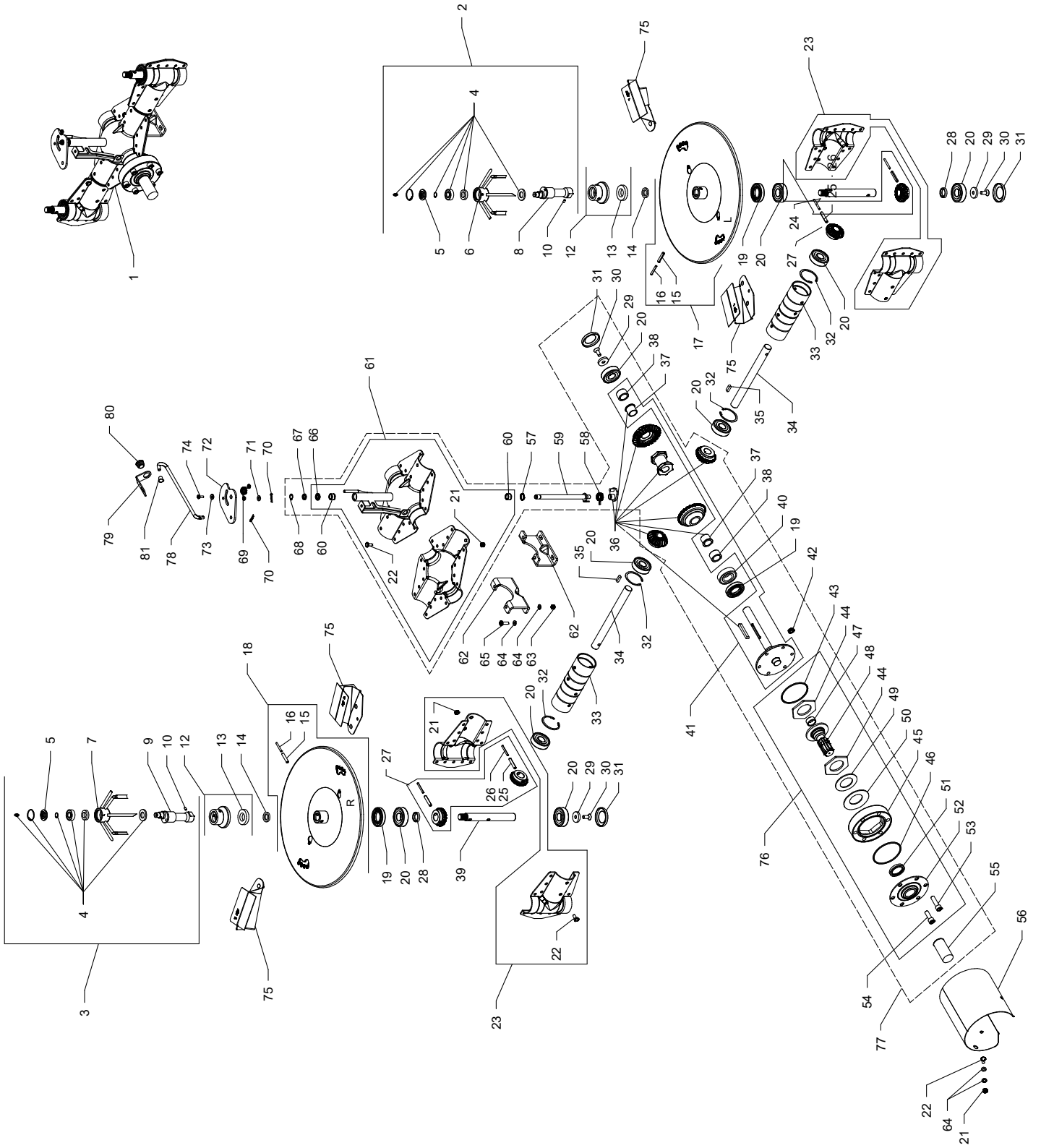

Pos. No.	Order no.	Notes.	Pos. No.	Order no.	Notes.
1	6750-02	540/750 rpm	47	9990-90	
2	4160-01	L-side/R-thread	48	3263-11	
3	4160-02	R-side/L-thread	49	3263-12	
4	4056-10		50	9931-10	
5	4056-03		51	9936-49	38x52x7
6	4058-05	L-side/R	52	3263-13	
7	4058-06	R-side/L	53	9965-10	M12x45
8	4161-02	L-side/R-thread	54	9965-09	M12x35
9	4161-01	R-side/L-thread	55	9985-84	
10	9961-02	M6x10	56	4470-01	
11	9913-19	M8x10	57	9931-15	
12	4158-05		58	9934-02	
13	4158-10		59	4653-02	
14	4560-01	ø20xø30x5	60	9990-99	ø14xø20x10
15	9933-10	ø8x40	61	4660-00	
16	9933-09	ø5x40	62	6750-04	
17	6751-01	Left	63	9969-32	M8 Lock nut
18	6751-02	Right	64	9930-32	D8/17
19	9936-37	35x62x12	65	9962-05	M8x25
20	9950-02	6305-2RS	66	9936-29	14x22x4
21	9969-31	M8	67	9936-28	
22	9962-03	M8x16	68	9937-13	U14
23	4454-05		69	9934-01	
24	4155-04	Right thread	70	9934-31	
25	9933-12	ø8x45	71	9930-51	
26	9933-17	ø5x45	72	4653-20	
27	3265-02	15 Teeth	73	9930-07	D6/17
28	3262-05		74	9961-04	M6x16
29	3260-04		75	6150-12	A2 T 2 Left / 2 Right
30	9963-07	M10x25	75	6150-18	A3 T 2 Left / 2 Right
31	3260-05		76	3263-10	
32	9937-40	160	77	4750-50	
33	6157-02		78	6394-78	
34	6156-02		79	6791-15	
35	9931-56	8x7x25	80	6350-12	
36	4652-11	17/24 Theeth	81	9990-26	
37	4652-08				
38	4652-03				
39	4062-05	Left thread			
40	9950-03	6206-2RS			
41	4652-01				
42	9928-99	M12			
43	9936-10	ø89,5xø3			
44	3263-15				
45	3263-20				
46	9936-09	ø94xø3			

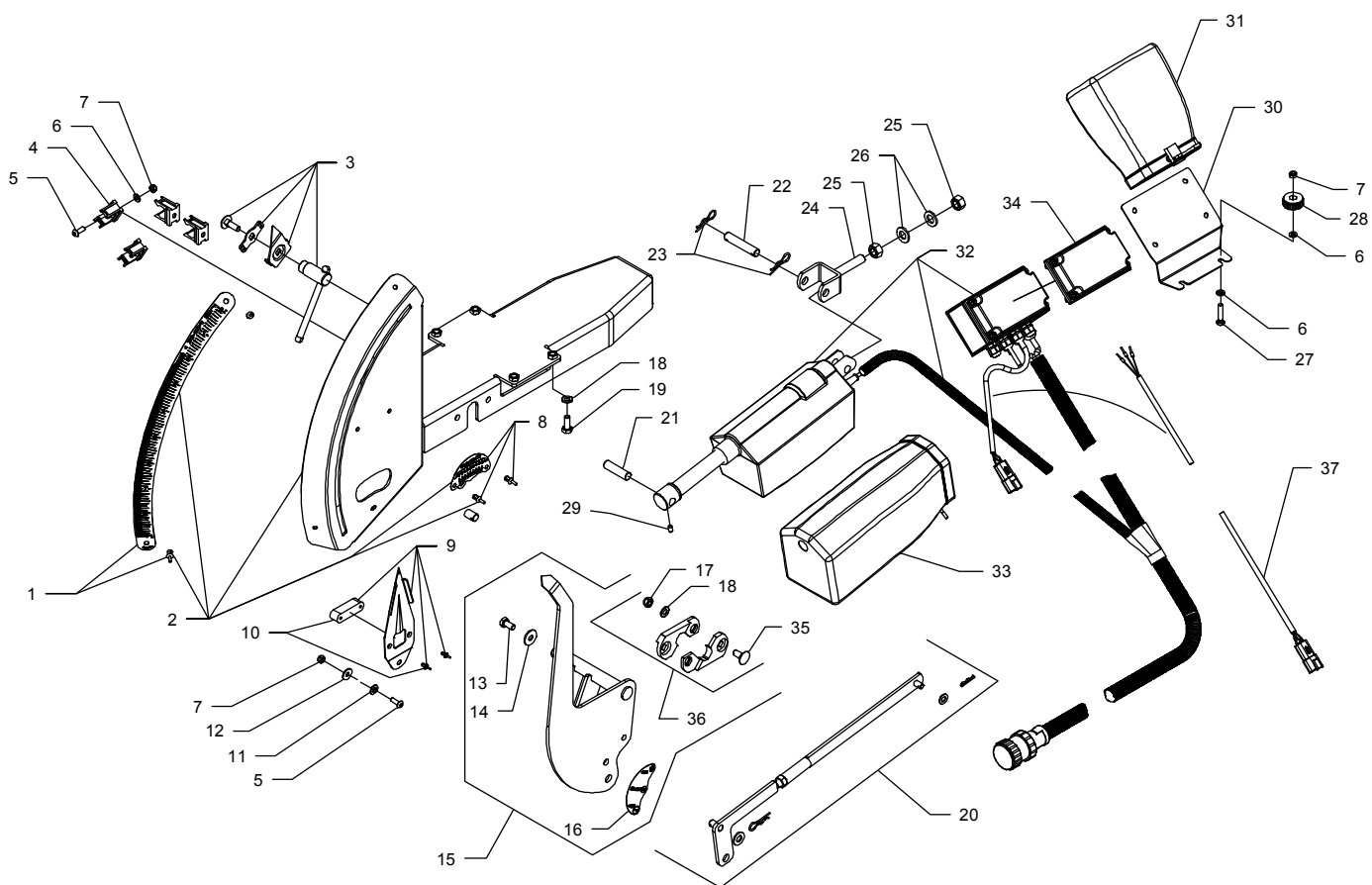

Pos. No.	Order no.	Notes.	Pos. No.	Order no.	Notes.
1	6381-03				
2	6381-04				
3	6381-13				
4	9989-85				
5	9961-21	M6x16			
6	9930-02	D6/12			
7	9969-16	M6			
8	6381-18				
9	6381-16				
10	6381-17				
11	9930-53	D8/15/3			
12	9930-03	D6/18			
13	9962-03	M8x16			
14	9930-31	D8/25			
15	6381-09				
16	9993-11				
17	9969-32	M8			
18	9930-32	D8/16			
19	9962-04	M8x20			
20	6481-05	M6W			
21	4584-08				
22	4581-28				
23	9934-32				
24	4581-25				
25	9969-60	M12			
26	9930-35	D12/24			
27	9961-23	M6x30			
28	9990-43				
29	9961-02	M6x10			
30	6384-29				
31	4584-26				
32	6384-26				
33	4584-25				
34	6386-26				
35	9962-25	M8x20			
36	6381-45				
37	6384-27	Dyn			

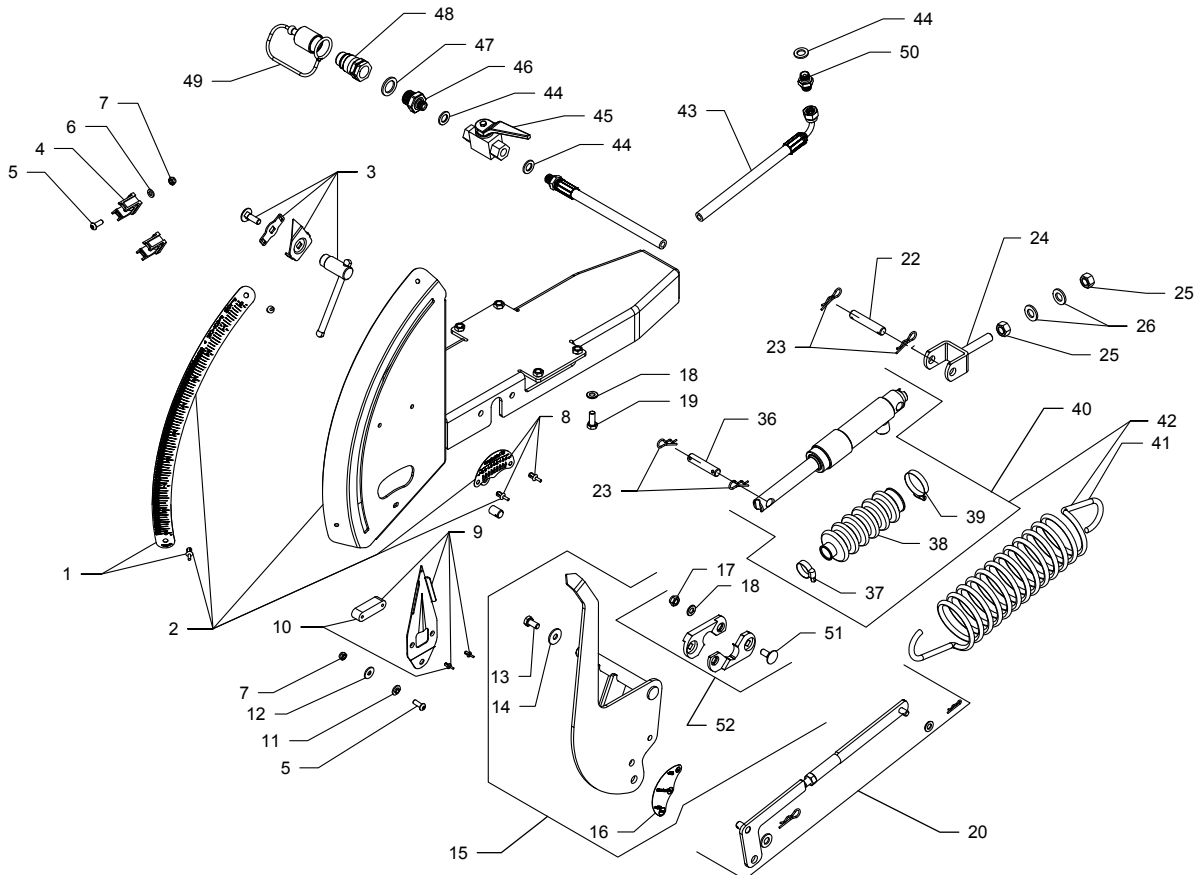
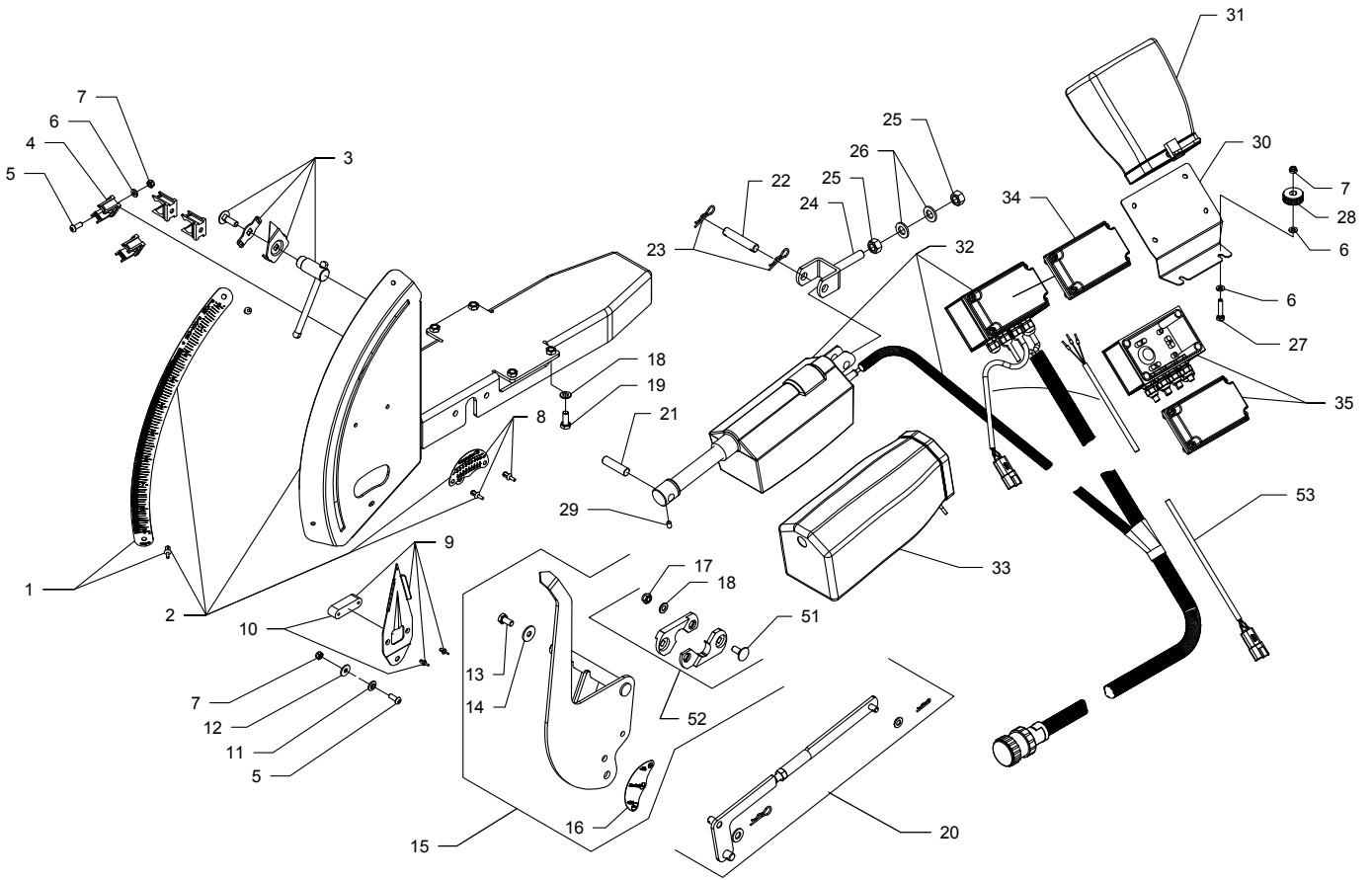

Pos. No.	Order no.	Notes.	Pos. No.	Order no.	Notes.
1	6381-03		46	9990-81	Ø0,8
2	6381-04		47	9936-80	
3	6381-13		48	9983-09	
4	9989-85		49	9990-19	
5	9961-21	M6x16	50	9990-78	
6	9930-03	D6/18	51	9962-25	M8x20
7	9969-16	M6	52	6381-45	
8	6381-18		53	6384-27	Dyn
9	6381-16				
10	6381-17				
11	9930-53	D8/15/3			
12	9930-03	D6/24			
13	9962-03	M8x16			
14	9930-31	D8/24			
15	6381-09				
16	9993-11				
17	9969-31	M8			
18	9930-32	D8/16			
19	9962-04	M8x20			
20	6384-19	M2W/M3W			
20	6381-19	M2/M3			
21	4584-08				
22	4581-28				
23	9934-32				
24	4581-25				
25	9969-60	M12			
26	9930-35	D12/24			
27	9961-23	M6x30			
28	9990-43				
29	9961-02	M6x10			
30	6384-29				
31	4584-26				
32	6384-26				
33	4584-25				
34	6386-26	M2W / M3W			
35	4920-50	M2(W)/M3(W)			
36	4581-29				
37	9990-60	D24			
38	9987-04				
39	9990-61	D40			
40	4581-15				
41	9934-14				
42	4581-37				
43	9983-29				
44	9936-79				
45	9982-06				

Pos. No.	Order no.	Notes.	Pos. No.	Order no.	Notes.
1	6840-25				
2	6840-20				
3	6381-13				
4	6885-10	L2			
5	9961-21	M6x16			
6	9930-03	D6/18			
7	9969-16	M6 Loc			
8	6381-18				
9	6381-16				
10	6381-17				
11	9930-53	D8/15/3			
12	4581-28				
13	9934-32				
14	4581-25				
15	9969-60	M12			
16	9930-35	D12/24			
17	9961-23	M6x30			
18	9990-43				
19	6384-29				
20	4584-26				
21	6384-28				
22	4584-25				
23	6386-26	L2W			
24	4920-50	L2(W)			
25	9930-02	D6/12			
26	4581-15				
27	9934-14				
28	9990-60	D24			
29	9987-04				
30	9990-61	D40			
31	9983-29				
32	9936-79				
33	9990-78				
34	9982-06				
35	9990-81	Ø0,8			
36	9936-80				
37	9983-09				
38	9990-19				
39	9965-01	M12x35			
40	9969-62	M12 Loc			
41	6785-07	L1			
42	6785-08	L1			

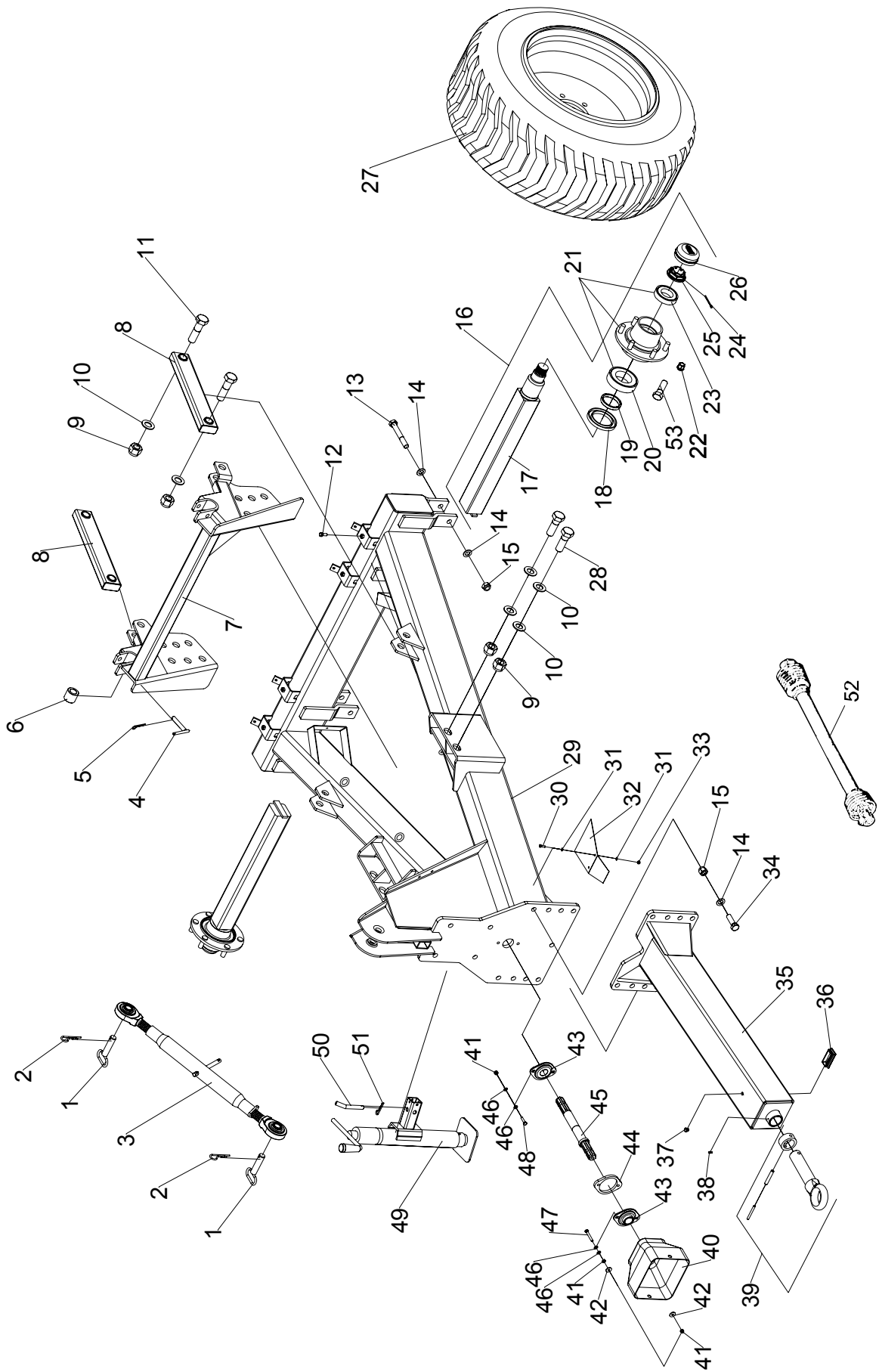

Pos. No.	Order no.	Notes	Pos. No.	Order no.	Notes
1	1811-80		47	9962-22	
2	9934-30		48	9962-21	
3	9981-80		49	1830-55	
4	1830-65		50	9524-05	
5	9934-32		51	9934-34	
6	1830-64		52	9985-41	
7	1830-70		53	9984-17	
8	1830-83				
9	9969-98				
10	9930-63				
11	9967-76				
12	9963-10				
13	9967-50				
14	9930-40				
15	9969-94				
16	1831-15				
17	9983-92				
18	9983-93				
19	9983-94				
20	9950-14				
21	9983-91				
22	9984-14				
23	9950-13				
24	9984-26				
25	9983-96				
26	9983-95	R/L			
27	9980-19				
28	9967-75				
29	1830-15				
30	9961-12				
31	9930-02				
32	1830-49				
33	9969-16				
34	9967-51				
35	1830-91				
36	9990-16				
37	9990-49				
38	9935-10				
39	9981-51				
40	9987-01				
41	9969-32				
42	9930-31				
43	9950-48				
44	1830-53				
45	1811-71				
46	9930-32				

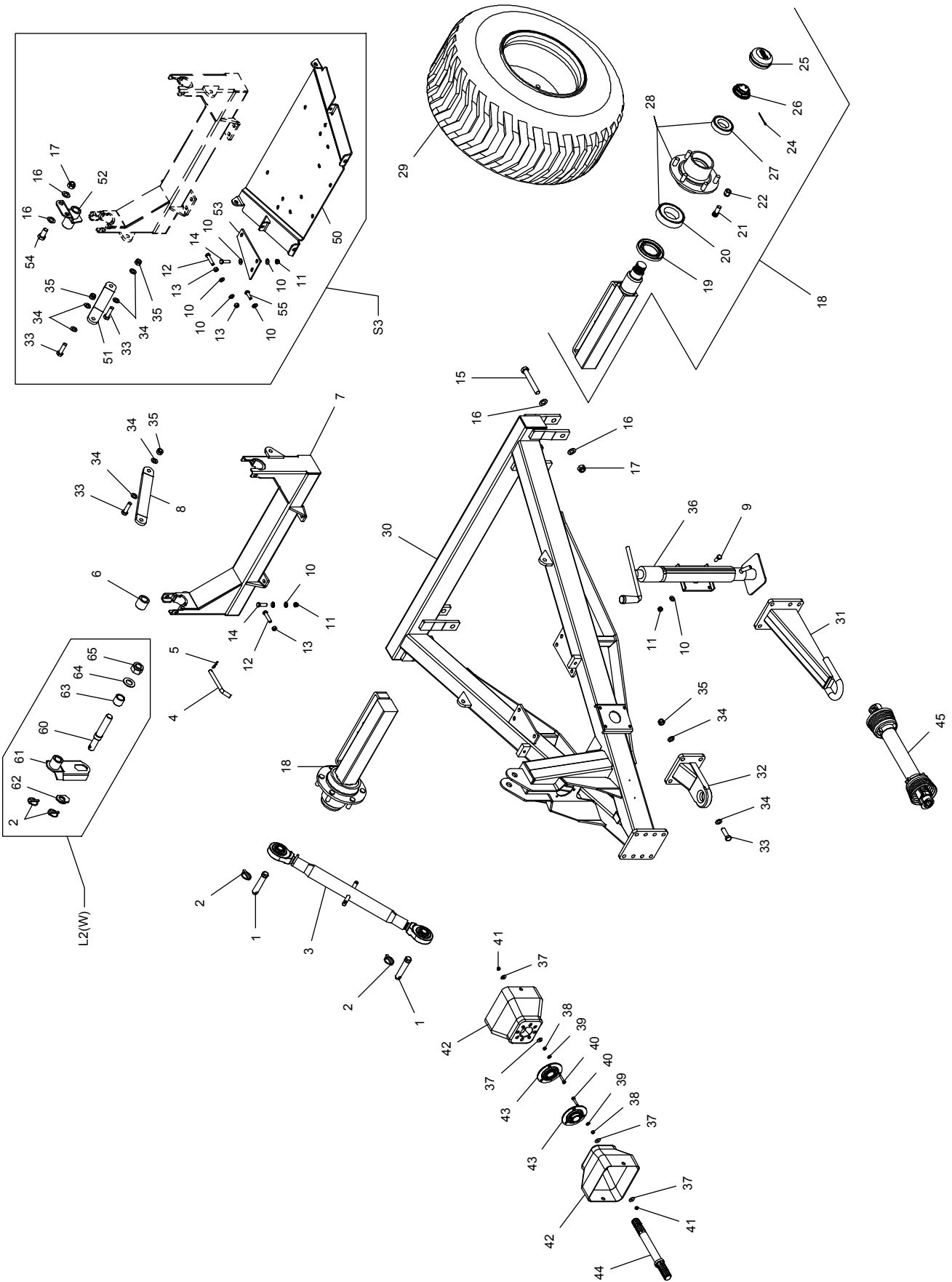

Pos. No.	Order no.	Notes.	Pos. No.	Order no.	Notes.
1	6320-04				
2	9938-74				
3	9981-80				
4	1810-84				
5	9934-32				
6	1830-64		50	1812-03	S3
7	1810-90	M2/M2W	51	1812-09	S3
8	1810-96		52	1812-05	S3
9	9965-03	M12x30	53	1812-04	S3
10	9930-35	D13/24	54	9965-00	M20x40
11	9969-62	M12 Loc	55	9965-01	M12x35
12	9965-06	M12x55			
13	9969-60	M12			
14	9965-05	M12x40			
15	9967-50	M20x140			
16	9930-40	D21/37	60	6981-75	L2(W)
17	9969-94	M20 Loc	61	6981-68	L2(W)
18	1810-03		62	6981-72	L2(W)
19	9984-54		63	6981-76	L2(W)
20	9950-12		64	9930-63	D31/56
21	9984-17		65	9969-98	M30 Loc
22	9984-14				
24	9984-26				
25	9984-55				
26	9984-56				
27	9950-11				
28	9984-53				
29	9980-20	400/60x15,5			
29	9980-18	11,5x15 AW			
30	1810-19				
31	1811-75				
32	1811-51				
33	9960-91	M16x55			
34	9930-20	D17/30			
35	9969-84	M16			
36	1550-30				
37	9930-31	D8/24			
38	9969-31	M8			
39	9930-32	D8/17			
40	9962-16	M8x40			
41	9969-32	M8 Loc			
42	9987-01				
43	9950-43	SB207/PF207			
44	1811-71				
45	9985-40	810 mm			
45	9985-41	1010 mm			

M2-Trail / L2-Trail

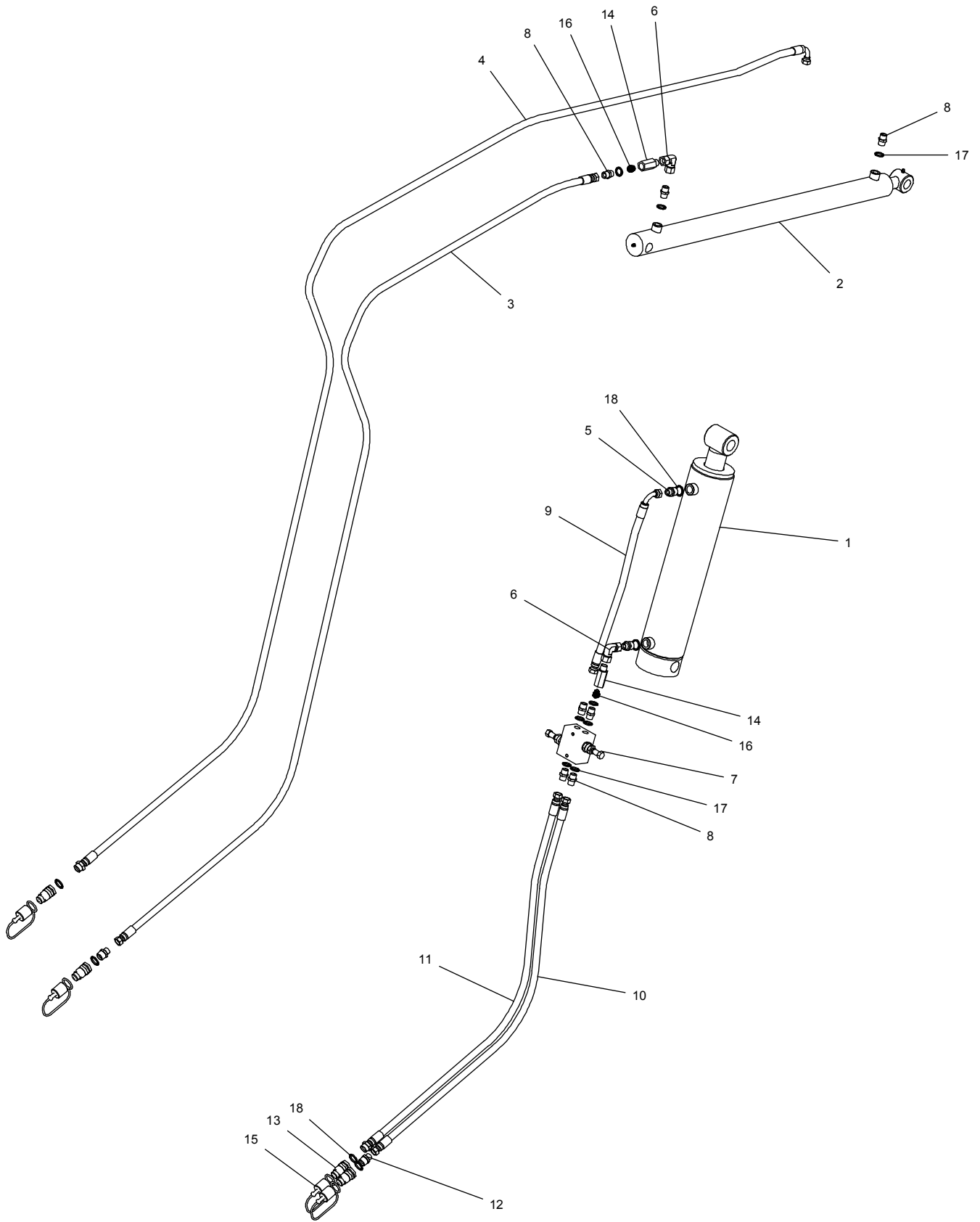

Pos. No.	Order no.	Notes.	Pos. No.	Order no.	Notes.
1	5693-15				
2	5693-01				
3	9983-25				
4	9983-26				
5	9995-01				
6	9995-05				
7	9982-10				
8	9995-02				
9	9983-23				
10	9983-22				
11	9983-24				
12	9995-03				
13	9983-09				
14	9982-11				
15	9990-19				
16	9982-12				
17	9936-82				
18	9936-80				

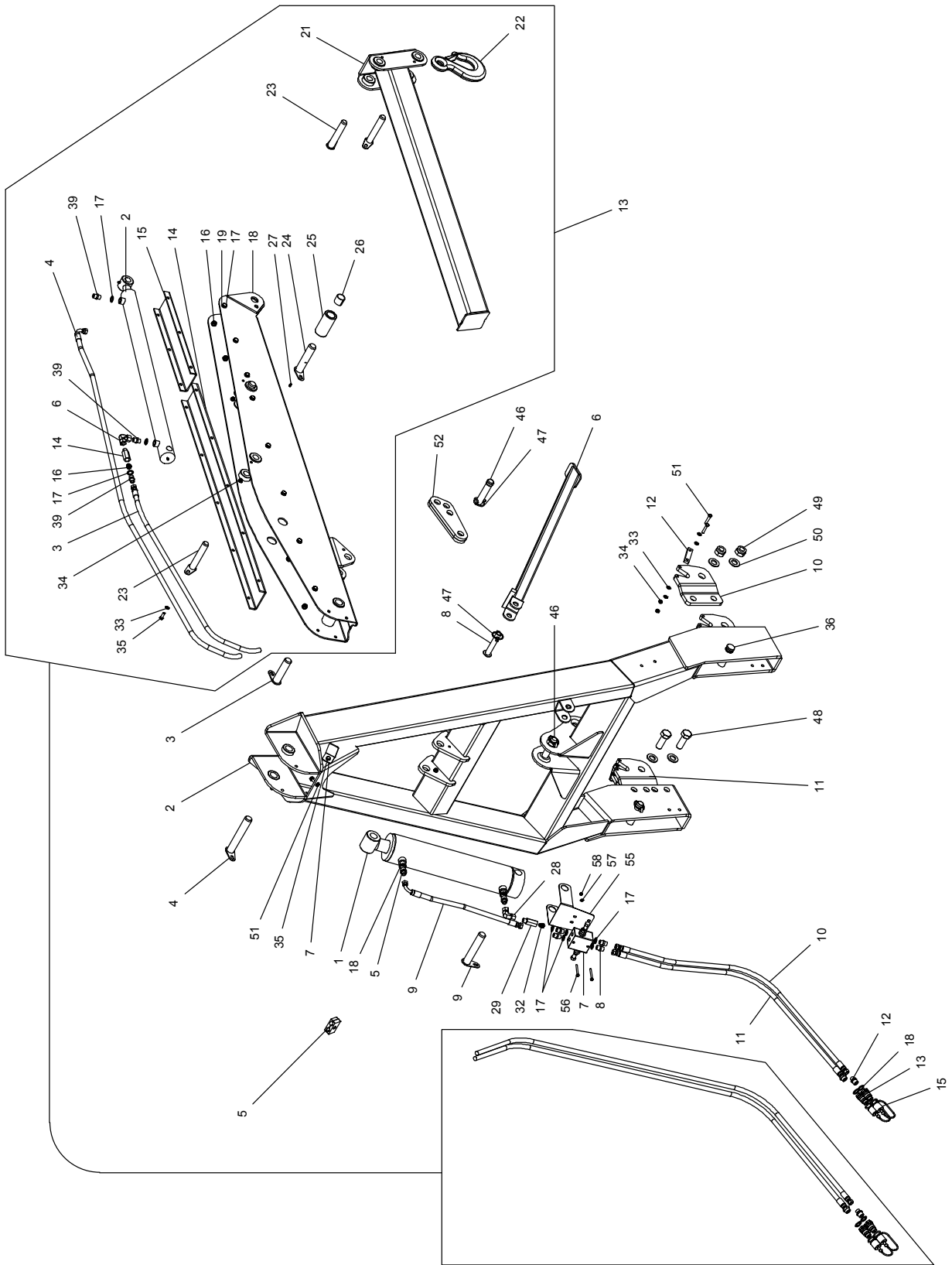

Pos. No.	Order no.	Notes.	Pos. No.	Order no.	Notes.
1	5693-15		47	9938-74	
2	5692-10		48	9967-60	M24x65
3	5692-67		49	9969-96	M24
4	5692-61		50	9930-01	D25/44x3
5	9990-33		51	9962-11	M8x40
6	5692-50		52	5692-85	
7	5692-56		53	9936-82	
8	5692-78		54	9936-80	
9	5692-64		55	5693-20	
10	5692-88		56	9961-17	M6x60
11	5692-89		57	9930-02	D6/14x1,6
12	5692-92		58	9969-16	M6
13	5692-30				
14	5692-33				
15	5692-34				
16	9969-45	M10			
17	9963-01	M10x25			
18	5692-35				
19	9968-44	D10/21x2			
20	5693-01				
21	5692-46				
22	9982-42				
23	5692-74				
24	5692-70				
25	5692-44				
26	9991-00				
27	9935-10				
28	9995-05				
29	9982-11				
30	9983-25	Lgt 3000mm			
31	9983-26	Lgt 3950mm			
32	9982-12				
33	9930-32	D8/17x1,6			
34	9969-32	M8			
35	9962-05	M8x25			
36	6320-03				
37	9995-01				
38	9982-10				
39	9995-02				
40	9983-23	Lgt 520mm			
41	9983-22	Lgt 1200 mm			
42	9983-24	Lgt 1200 mm			
43	9995-03				
44	9983-09				
45	9990-19				
46	6320-04				



BOGBALLE A/S · Bogballe · DK-7171 Uldum · www.bogballe.com
Phone +45 7589 3266 · Fax +45 7589 3766 · bogballe@bogballe.com